

Dell PowerConnect
5500 Series
System User Guide

Regulatory Models: PowerConnect 5524, 5524P, 5548, 5548P



Notes, Cautions, and Warnings



NOTE: A NOTE indicates important information that helps you make better use of your system.



CAUTION: A CAUTION indicates potential damage to hardware or loss of data if instructions are not followed.



WARNING: A WARNING indicates a potential for property damage, personal injury, or death.

**Information in this document is subject to change without notice.
© 2012 Dell Inc. All rights reserved.**

Reproduction of these materials in any manner whatsoever without the written permission of Dell Inc. is strictly forbidden.

Trademarks used in this text: Dell™, the DELL logo, and PowerConnect™ are trademarks of Dell Inc.; Intel®, Pentium®, and Celeron® are registered trademarks of Intel Corporation in the U.S. and other countries; Microsoft® and Windows® are either trademarks or registered trademarks of Microsoft Corporation in the United States and/or other countries.

Other trademarks and trade names may be used in this document to refer to either the entities claiming the marks and names or their products. Dell Inc. disclaims any proprietary interest in trademarks and trade names other than its own.

Regulatory Models PC5524, PC5524P, PC5548 and PC5548P

May 2012 A05

Table of Contents

1	Preface	13
2	Features	14
	IP Version 6 (IPv6) Support	15
	Stack Support	15
	Power over Ethernet	15
	Green Ethernet	16
	Head of Line Blocking Prevention	16
	Flow Control Support (IEEE 802.3X)	16
	Back Pressure Support	16
	Virtual Cable Testing (VCT)	17
	Auto-Negotiation	17
	MDI/MDIX Support	17
	MAC Address Supported Features	17
	Layer 2 Features	19
	IGMP Snooping	19
	Port Mirroring	19
	Broadcast Storm Control	19
	VLAN Supported Features	20

	Spanning Tree Protocol Features	21
	Link Aggregation	23
	Quality of Service Features	23
	Device Management Features	24
	Security Features	28
	Port Profile (CLI Macro)	30
	DHCP Server	31
	Protected Ports	31
	iSCSI Optimization	31
	Proprietary Protocol Filtering	31
3	Hardware Description	33
	Device Models	34
	Device Structure	34
	LED Definitions	38
	Power Supplies	42
4	Stacking Overview	43
	Stack Overview	44
	Stack Members and Unit IDs	47

5	Configuring the Switch	54
	Configuration Work Flow	55
	Connecting the Switch to the Terminal	56
	Booting the Switch	57
	Configuring the Stack	58
	Configuration Using the Setup Wizard	58
6	Advanced Switch Configuration	63
	Using the CLI	64
	Accessing the Device Through the CLI	67
	Retrieving an IP Address	68
	Security Management and Password Configuration	71
	Configuring Login Banners	74
	Startup Menu Procedures	76
	Software Download	79
7	Using Dell OpenManage Administrator.	83
	Starting the Application	84
	Understanding the Interface.	84
	Using the Switch Administrator Buttons	87
	Field Definitions	89
	Common GUI Features	89

	GUI Terms	90
	CLI Commands	90
8	Network Security	92
	Port Security	93
	ACLs	98
	ACL Binding	118
	Proprietary Protocol Filtering	120
	Time Range	122
	Dot1x Authentication	127
9	Configuring System Information	150
	General Switch Information	151
	Time Synchronization	162
	Logs	188
	IP Addressing	202
	Diagnostics	248
	Management Security	254
	DHCP Server	290
	SNMP	307
	File Management	330
	Stack Management	361

sFlow	369
10 Ports	378
Overview	379
Jumbo Frames	382
Green Ethernet Configuration	384
Protected Ports	388
Port Profile	391
Port Configuration	397
LAG Configuration	403
Storm Control	408
Port Mirroring	411
11 Address Tables	416
Overview	417
Static Addresses	418
Dynamic Addresses	421
12 GARP	424
GARP Overview	425
GARP Timers	426

13 Spanning Tree	428
Spanning Tree Protocol Overview	429
Global Settings	431
STP Port Settings	436
STP LAG Settings	441
Rapid Spanning Tree	444
Multiple Spanning Tree	448
14 VLANs	459
Virtual LAN Overview	460
VLAN Membership	465
Port Settings	468
LAGs Settings	474
Protocol Groups	477
Protocol Port	481
GVRP Parameters	483
Private VLAN	487
Voice VLAN	491
15 Link Aggregation	500
Link Aggregation Overview	501
LACP Parameters	503

	LAG Membership	506
16	Multicast	508
	Multicast Support Overview	509
	Global Parameters	511
	Bridge Multicast Groups	513
	Bridge Multicast Forward All	517
	IGMP Snooping	519
	Unregistered Multicast	525
	Multicast TV VLAN	527
17	LLDP	531
	LLDP Overview	532
	LLDP Properties	533
	LLDP Port Settings	537
	MED Network Policy	540
	LLDP MED Port Settings	543
	Neighbors Information	548
18	Dynamic ARP Inspection	551
	Dynamic ARP Inspection Overview	552
	Global Settings	553

Dynamic ARP Inspection List	555
Dynamic ARP Inspection Entries	557
VLAN Settings	559
Trusted Interfaces	561
19 DHCP Snooping	563
DHCP Snooping	564
DHCP Relay	577
20 iSCSI Optimization	584
Optimizing iSCSI Overview	585
Global Parameters	588
iSCSI Targets	591
iSCSI Sessions	593
Configuring iSCSI Using CLI	595
21 Statistics/RMON	596
Table Views	597
RMON Components	615
Charts	633

22 Quality of Service	640
QoS Features and Components	641
General	643
QoS Basic Mode	659
QoS Advanced Mode	668
QoS Statistics	688
Glossary	695
Index	710
Revision History	727

Preface

PowerConnect 5524/5548 and PowerConnect 5524P/5548P are stackable, advanced multi-layer devices.

This guide contains the information needed for installing, configuring, and maintaining the device through the web-based management system, called the OpenManage Switch Administrator.

This guide describes how to configure each system through the web-based management system and through CLI commands.

The *CLI Reference Guide*, which is available on the Documentation CD, provides additional information about the CLI commands.

Features

This section describes the features of the PowerConnect 5524/P and 5548/P switches.

For a complete list of all updated device features, see the latest software version **Release Notes**.

This section contains the following topics:

- IP Version 6 (IPv6) Support
- Stack Support
- Power over Ethernet
- Green Ethernet
- Head of Line Blocking Prevention
- Flow Control Support (IEEE 802.3X)
- Back Pressure Support
- Virtual Cable Testing (VCT)
- Auto-Negotiation
- MDI/MDIX Support
- MAC Address Supported Features
- Layer 2 Features
- IGMP Snooping
- Port Mirroring
- Broadcast Storm Control
- VLAN Supported Features
- Spanning Tree Protocol Features
- Link Aggregation
- Quality of Service Features
- Quality of Service Features
- Device Management Features

- Security Features
- DHCP Server
- Protected Ports
- iSCSI Optimization
- Proprietary Protocol Filtering

IP Version 6 (IPv6) Support

The device functions as an IPv6-compliant host, as well as an IPv4 host (also known as dual stack). This enables device operation in a pure IPv6 network as well as in a combined IPv4/IPv6 network.

For more information, see "IP Addressing" on page 202.

Stack Support

The system supports up to eight units with two fixed HDMI stacking ports. The HDMI ports are 1.3a specification, Category 2 High Speed cables, 340 MHz (10.2 Gbit/s).



it is recommended to use HDMI cable version 1.4

The stacking feature supports the following features:

- Fast-link failover
- Software auto-synch.
- Improved response time to events, such as master failover
- Auto-numbering algorithm when choosing unit number

For more information, see "Stacking Overview" on page 43

Power over Ethernet

Power over Ethernet (PoE) provides power to devices over existing LAN cabling, without updating or modifying the network infrastructure. When PoE is used, the network devices do not have to be placed next to a power source. PoE can be used in the following applications:

- IP Phones
- Wireless Access Points

- IP Gateways
- PDAs
- Audio and video remote monitoring

For more information, see "Power over Ethernet" on page 157.

Green Ethernet

Green Ethernet, also known as Energy Efficient Ethernet (EEE), is an effort to make networking equipment environmentally friendly, by reducing the power usage of Ethernet connections.

The Short-Reach method, which reduces power over Ethernet cables shorter than 40m, is supported by the device.

For more information, see "Green Ethernet Configuration" on page 384.

Head of Line Blocking Prevention

Head of Line (HOL) blocking results in traffic delays and frame loss caused by traffic competing for the same egress port resources. To prevent HOL blocking, the device queues packets, and packets at the head of the queue are forwarded before packets at the end of the queue.

Flow Control Support (IEEE 802.3X)

Flow control enables lower-speed devices to communicate with higher-speed devices, by requesting that the higher-speed device refrain from sending packets. Transmissions are temporarily halted to prevent buffer overflows.

For more information, see "Flow Control" on page 380.

Back Pressure Support

On half-duplex links, the receiving port prevents buffer overflows by occupying the link so that it is unavailable for additional traffic.

For more information, see "Protected Ports" on page 388.

Virtual Cable Testing (VCT)

VCT detects and reports copper link cabling faults, such as open cables and cable shorts.

For more information, see "Diagnostics" on page 248.

Auto-Negotiation

Auto-negotiation enables the device to advertise modes of operation. The auto-negotiation function enables an exchange of information between two devices that share a point-to-point link segment, and automatically configures both devices to take maximum advantage of their transmission capabilities.

The PowerConnect 5500 series enhances auto-negotiation by providing port advertisement. Port advertisement enables the system administrator to configure the port speeds that are advertised.

For more information, see "Port Configuration" on page 397 or "LAG Configuration" on page 403.

MDI/MDIX Support

Standard wiring for end stations is known as **Media-Dependent Interface** (MDI), and standard wiring for hubs and switches is known as **Media-Dependent Interface with Crossover** (MDIX).

If auto-negotiation is enabled, the device automatically detects whether the cable connected to an RJ-45 port is MDIX (crossed) or MDI (straight). This enables both types to be used interchangeably.

If auto-negotiation is not enabled, only MDI (straight) cables can be used.

For more information, see "Port Configuration" on page 397 or "LAG Configuration" on page 403.

MAC Address Supported Features

MAC Address Capacity Support

The device supports up to 16K MAC addresses and it reserves specific MAC addresses for system use.

Static MAC Entries

MAC entries can be manually entered in the Bridging Table, as an alternative to learning them from incoming frames. These user-defined entries are not subject to aging, and are preserved across resets and reboots.

For more information, see "Static Addresses" on page 418.

Self-Learning MAC Addresses

The device enables controlled MAC address learning from incoming packets. The MAC addresses are stored in the Bridging Table.

For more information, see "Dynamic Addresses" on page 421.

Automatic Aging for MAC Addresses

MAC addresses from which no traffic is received for a given period, are aged out. This prevents the Bridging Table from overflowing.

For more information, see "Dynamic Addresses" on page 421.

VLAN-Aware MAC-Based Switching

The device always performs VLAN-aware bridging. Classic bridging (IEEE802.1D), in which frames are forwarded based only on their destination MAC address, is not performed. However, a similar functionality can be configured for untagged frames. Frames addressed to a destination MAC address that is not associated with any port are flooded to all ports of the relevant VLAN.

MAC Multicast Support

Multicast service is a limited Broadcast service that enables one-to-many and many-to-many connections for information distribution. In Layer 2 Multicast service, a single frame is addressed to a specific Multicast address, from which copies of the frame are transmitted to the relevant ports. When Multicast groups are statically enabled, you can set the destination port of registered groups, as well as define the behavior of unregistered Multicast frames.

For more information, see "Multicast" on page 508.

Layer 2 Features

IGMP Snooping

Internet Group Membership Protocol (IGMP) Snooping examines IGMP frame contents, when they are forwarded by the device from work stations to an upstream Multicast router. From the frame, the device identifies work stations configured for Multicast sessions, and which Multicast routers are sending Multicast frames. The IGMP Querier simulates the behavior of a Multicast router. This enables snooping of the Layer 2 Multicast domain even if there is no Multicast router.

For more information, see "IGMP Snooping" on page 519.

Port Mirroring

Port mirroring monitors network traffic by forwarding copies of incoming and outgoing packets from a monitored port to a monitoring port. Users specify which target port receives copies of all traffic passing through a specified source port.

For more information, see "Port Mirroring" on page 411.

Broadcast Storm Control

Storm Control enables limiting the number of Multicast and Broadcast frames accepted by and forwarded by the device.

When Layer 2 frames are forwarded, Broadcast and Multicast frames are flooded to all ports on the relevant VLAN. This occupies bandwidth, and loads all nodes connected on all ports.

For more information, see "Storm Control" on page 408.

VLAN Supported Features

VLAN Support

VLANs are collections of switching ports that comprise a single Broadcast domain. Packets are classified as belonging to a VLAN, based on either the VLAN tag or on a combination of the ingress port and packet contents. Packets sharing common attributes can be grouped in the same VLAN.

For more information, see "VLANs" on page 459.

Port-Based Virtual LANs (VLANs)

Port-based VLANs classify incoming packets to VLANs, based on their ingress port.

For more information, see "Defining VLAN Membership Using CLI Commands" on page 466.

Full 802.1Q VLAN Tagging Compliance

IEEE 802.1Q defines an architecture for virtual, bridged LANs, the services provided in VLANs, and the protocols and algorithms involved in the provision of these services.

For more information, see "Virtual LAN Overview" on page 460.

GVRP Support

GARP VLAN Registration Protocol (GVRP) provides IEEE 802.1Q-compliant VLAN pruning and dynamic VLAN creation on 802.1Q trunk ports. When GVRP is enabled, the device registers and propagates VLAN membership on all ports that are part of the active underlying Spanning Tree Protocol topology.

For more information, see "GVRP Parameters" on page 483.

Voice VLAN

Voice VLAN enables network administrators to enhance VoIP service by configuring ports to carry IP voice traffic from IP phones on a specific VLAN. VoIP traffic has a preconfigured OUI prefix in the source MAC address. Network administrators can configure VLANs from which voice IP traffic is

forwarded. Non-VoIP traffic is dropped from the Voice VLAN in Auto-Voice VLAN Secure mode. Voice VLAN also provides QoS to VoIP, ensuring that the quality of voice does not deteriorate if the IP traffic is received unevenly.

For more information, see "Voice VLAN" on page 491.

Guest VLAN

Guest VLAN provides limited network access to unauthorized ports. If a port is denied network access via port-based authorization, but the Guest VLAN is enabled, the port receives limited network access through the Guest VLAN.

For more information, see "Dot1x Authentication" on page 127.

Private VLAN

The Private VLAN feature provides Layer 2 isolation between ports that share the same Broadcast domain, or in other words, it creates a point-to-multipoint Broadcast domain. The ports can be located anywhere in the Layer 2 network (compared to the Protected Ports feature, where the ports must be in the same stack).

For more information, see "Private VLAN" on page 487.

Multicast TV VLAN

The Multicast TV VLAN feature provides the ability to supply multicast transmissions to Layer 2-isolated subscribers, without replicating the multicast transmissions for each subscriber VLAN. The subscribers are the only receivers of the multicast transmissions.

For more information, see "Multicast TV VLAN" on page 527.

Spanning Tree Protocol Features

Spanning Tree Protocol (STP)

802.1d Spanning tree is a standard Layer 2 switch requirement that enables bridges to automatically prevent and resolve Layer 2 forwarding loops. Switches exchange configuration messages using specifically-formatted frames, and selectively enable and disable forwarding on ports.

For more information, see "Spanning Tree" on page 428.

Fast Link

STP can take 30–60 seconds to converge. During this time, STP detects possible loops, enabling time for status changes to propagate and for relevant devices to respond. This period of 30-60 seconds is considered too long a response time for many applications. The Fast Link option bypasses this delay, and can be used in network topologies, where forwarding loops do not occur.

For more information on enabling Fast Link for ports and LAGs, see "STP Port Settings" on page 436 or "Static Addresses" on page 418.

IEEE 802.1w Rapid Spanning Tree

Spanning Tree takes 30–60 seconds for each host to decide whether its ports are actively forwarding traffic. Rapid Spanning Tree (RSTP) detects uses of network topologies to enable faster convergence, without creating forwarding loops.

For more information, see "Spanning Tree" on page 428.

IEEE 802.1s Multiple Spanning Tree

Multiple Spanning Tree (MSTP) operation maps VLANs into STP instances. MSTP provides a different load balancing scenario. Packets assigned to various VLANs are transmitted along different paths within MSTP Regions (MST Regions). Regions are one or more MSTP bridges by which frames can be transmitted. The standard lets administrators assign VLAN traffic to unique paths.

For more information, see "Spanning Tree" on page 428.

STP BPDU Guard

BPDU Guard is used as a security mechanism, to protect the network from invalid configurations.

BPDU Guard is usually used either when fast link ports (ports connected to clients) are enabled or when the STP feature is disabled. When it is enabled on a port, the port is shut down if a BPDU message is received and an appropriate SNMP trap is generated.

For more information, see "Spanning Tree" on page 428.

Link Aggregation

Up to 32 Aggregated Links may be defined, each with up to eight member ports, to form a single Link Aggregated Group (LAG). This enables:

- Fault tolerance protection from physical link disruption
- Higher bandwidth connections
- Improved bandwidth granularity
- High bandwidth server connectivity

A LAG is composed of ports with the same speed, set to full-duplex operation.

For more information, see "LAG Configuration" on page 403.

Link Aggregation and LACP

LACP uses peer exchanges across links to determine, on an ongoing basis, the aggregation capability of various links, and continuously provides the maximum level of aggregation capability achievable between a given pair of devices. LACP automatically determines, configures, binds, and monitors the port binding within the system.

For more information, see "Link Aggregation" on page 500.

BootP and DHCP Clients

DHCP enables additional setup parameters to be received from a network server upon system startup. DHCP service is an on-going process. DHCP is an extension of BootP.

For more information, see "DHCP IPv4 Interface" on page 207.

Quality of Service Features

Class of Service 802.1p Support

The IEEE 802.1p signaling technique is an OSI Layer 2 standard for marking and prioritizing network traffic at the data link/MAC sub-layer. 802.1p traffic is classified and sent to the destination. No bandwidth reservations or limits

are established or enforced. 802.1p is a spin-off of the 802.1Q (VLANs) standard. 802.1p establishes eight levels of priority, similar to the IP Precedence IP Header bit-field.

Advanced QoS

Frames that match an ACL and were permitted entrance are implicitly labeled with the name of the ACL that permitted their entrance. Advanced mode QoS actions defined in network policies can then be applied to these flows.

The switch can set DSCP values and map IPv6 DSCP to egress queues in the same way it does for IPv4. The switch detects IPv6 frames by the IPv6 ether-type.

For more information about Advanced QoS, see "QoS Advanced Mode" on page 668.

TCP Congestion Avoidance

The TCP Congestion Avoidance feature activates an algorithm that breaks up or prevents TCP global synchronization on a congested node, where the congestion is due to multiple sources sending packets with the same byte count.

For more information, see "The following is an example of the CLI commands:" on page 656.

Device Management Features

SNMP Alarms and Trap Logs

The system logs events with severity codes and timestamps. Events are sent as SNMP traps to a Trap Recipient List.

For more information, see "SNMP" on page 307.

SNMP Versions 1, 2, and 3

Simple Network Management Protocol (SNMP) over the UDP/IP protocol controls access to the system. A list of community entries is defined, each consisting of a community string and its access privileges. There are three levels of SNMP security: read-only, read-write, and super. Only a super user can access the Community table.

For more information, see "SNMP" on page 307.

Web-Based Management

Web-based management enables managing the system from any web browser. The system contains an Embedded Web Server (EWS) that serves HTML pages, through which the system can be monitored and configured. The system internally converts web-based input into configuration commands, MIB variable settings, and other management-related settings.

Management IP Address Conflict Notification

This feature validates the uniqueness of the switch's IP address, whether it is assigned manually or through DHCP. If the IP address is not unique, the switch performs actions according to the address type. If the IP address is static, see more information about this in "IPv4 Interface Parameters" on page 203. If the IP address is dynamic, see more information about this in "DHCP IPv4 Interface" on page 207.

Flow Monitoring (sflow)

The switch supports statistics collection, using a sampling technology called sFlow that is based on RFC 3176. The sFlow sampling technology is embedded within the switch, and provides the ability to continuously monitor traffic flows on some or all the interfaces simultaneously.

For more information, see "sFlow" on page 369.

Configuration File Download and Upload

The device configuration is stored in a configuration file. The configuration file includes both system-wide and port-specific device configuration. The system can display configuration files as a collection of CLI commands that are stored and manipulated as text files.

Auto-Update of Configuration/Image File

This feature facilitates installation of new devices. When you enable the various auto-update options, the device automatically downloads a new image or configuration file when it receives its IP address from a TFTP server, and automatically reboots, using the image or configuration file it received.

For more information, see "Auto-Update/Configuration Feature" on page 331.

TFTP Trivial File Transfer Protocol

The device supports boot image, software, and configuration upload/download via TFTP.

USB File Transfer Protocol

The device supports boot image, software, and configuration upload/download via USB.

Remote Monitoring

Remote Monitoring (RMON) is an extension to SNMP that provides comprehensive network traffic monitoring capabilities. RMON is a standard MIB that defines MAC-layer statistics and control objects, enabling real-time information to be captured across the entire network.

For more information, see "Statistics/RMON" on page 596.

Command Line Interface

Command Line Interface (CLI) syntax and semantics conform as much as possible to common, industry standards. CLI is composed of mandatory and optional elements. The CLI interpreter provides command and keyword completion to assist users and save typing.

Syslog

Syslog is a protocol that enables event notifications to be sent to a set of remote servers, where they can be stored, examined, and acted upon. The system sends notifications of significant events in real time, and keeps a record of these events for after-the-fact usage.

For more information on Syslog, see "Logs" on page 188.

SNTP

The Simple Network Time Protocol (SNTP) assures accurate network Ethernet Switch clock time synchronization up to the millisecond. Time synchronization is performed by a network SNTP server. Time sources are prioritized by strata. Strata define the distance from the reference clock. The higher the stratum (where zero is the highest), the more accurate the clock.

For more information, see "Time Synchronization" on page 162.

Domain Name System

Domain Name System (DNS) converts user-defined domain names into IP addresses. Each time a domain name is assigned, the DNS service translates the name into a numeric IP address. For example, `www.ipexample.com` is translated into `192.87.56.2`. DNS servers maintain domain name databases containing their corresponding IP addresses.

For more information, see "Domain Name System" on page 235.

802.1ab (LLDP-MED)

The Link Layer Discovery Protocol (LLDP) enables network managers to troubleshoot, and enhances network management by discovering and maintaining network topologies over multi-vendor environments. LLDP discovers network neighbors by standardizing methods for network devices to advertise themselves to other systems, and to store discovered information. The multiple advertisement sets are sent in the packet **Type Length Value** (TLV) field. LLDP devices must support chassis and port ID advertisement, as well as system name, system ID, system description, and system capability advertisements.

LLDP Media Endpoint Discovery (LLDP-MED) increases network flexibility by enabling various IP systems to co-exist on a single network LLDP. It provides detailed network topology information, emergency call service via IP phone location information, and troubleshooting information.

For more information, see "LLDP" on page 531.

Security Features

SSL

Secure Socket Layer (SSL) is an application-level protocol that enables secure transactions of data through privacy, authentication, and data integrity. It relies upon certificates and public and private keys.

Port-Based Authentication (Dot1x)

Port-based authentication enables authenticating system users on a per-port basis via an external server. Only authenticated and approved system users can transmit and receive data. Ports are authenticated via the Remote Authentication Dial-In User Service (RADIUS) server using the Extensible Authentication Protocol (EAP). Dynamic VLAN Assignment (DVA) enables network administrators to automatically assign users to VLANs during the RADIUS server authentication.

For more information, see "Dot1x Authentication" on page 127.

Locked Port Support

Locked Port increases network security by limiting access on a specific port to users with specific MAC addresses. These addresses are either manually defined or learned on that port. When a frame is seen on a locked port, and the frame source MAC address is not tied to that port, the protection mechanism is invoked.

For more information, see "Port Security" on page 93.

RADIUS Client

RADIUS is a client/server-based protocol. A RADIUS server maintains a user database that contains per-user authentication information, such as user name, password, and accounting information.

RADIUS Accounting

This feature enables recording device management sessions (Telnet, serial, and WEB but not SNMP) and/or 802.1x authentication sessions.

Due to the complexity of 802.1x setup and configuration, many mistakes can be made that might cause loss of connectivity or incorrect behavior. The 802.1x Monitor mode enables applying 802.1x functionality to the switch, with all necessary RADIUS and/or domain servers active, without actually taking any action that may cause unexpected behavior. In this way, the user can test the 802.1x setup before actually applying it.

For more information, see "RADIUS" on page 284.

SSH

Secure Shell (SSH) is a protocol that provides a secure, remote connection to a device. SSH version 2 is currently supported. The SSH server feature enables an SSH client to establish a secure, encrypted connection with a device. This connection provides functionality that is similar to an inbound telnet connection. SSH uses RSA and DSA Public Key cryptography for device connections and authentication.

For more information, see "Security Management and Password Configuration" on page 71.

TACACS+

TACACS+ provides centralized security for validation of users accessing the device. TACACS+ provides a centralized, user management system, while still retaining consistency with RADIUS and other authentication processes.

For more information, see "TACACS+" on page 275.

Password Management

Password management provides increased network security and improved password control. Passwords for SSH, Telnet, HTTP, HTTPS, and SNMP access are assigned security features.

For more information, see "Password Management" on page 279.

The switch provides the ability to demand strong passwords, meaning that they must contain both upper and lower-case letters, numbers, and punctuation marks.

For more information, see "Password Management" on page 279.

Access Control Lists (ACL)

Access Control Lists (ACL) enable network managers to define classification actions and rules for specific ingress ports. Packets entering an ingress port with an active ACL, are either admitted or denied entry and the ingress port is disabled. If they are denied entry, the user can disable the port.

Dynamic ACL/Dynamic Policy Assignment (DACL/DPA)

The network administrator can specify the user's ACL in the RADIUS server. After successful authentication, the user is assigned that ACL.

For more information, see "Network Security" on page 92.

DHCP Snooping

DHCP Snooping expands network security by providing firewall security between untrusted interfaces and DHCP servers. By enabling DHCP Snooping, network administrators can differentiate between trusted interfaces connected to end-users or DHCP servers and untrusted interfaces located beyond the network firewall.

For more information, see "DHCP Snooping" on page 564.

ARP Inspection

Dynamic ARP inspection is a security feature that validates ARP packets in a network. It intercepts, logs, and discards ARP packets with invalid IP-to-MAC address bindings. This capability protects the network from certain man-in-the-middle attacks.

Port Profile (CLI Macro)

Macros provide a convenient way to save and share a common configuration. A macro is a set of CLI commands with a unique name. When a macro is applied to a port, the CLI commands contained within it are executed and added to the Running Configuration file.

For more information, see "Dynamic ARP Inspection" on page 551.

DHCP Server

Dynamic Host Configuration Protocol (DHCP) provides a means of passing configuration information (including the IP address of a TFTP server and a configuration file name) to hosts on a TCP/IP network. The switch can serve as a DHCP server or client.

For more information on the device serving as a DHCP server, see "DHCP Server" on page 290.

For more information on the device serving as a DHCP client, see "DHCP IPv4 Interface" on page 207.

Protected Ports

The Protected Ports feature provides Layer 2 isolation between interfaces (Ethernet ports and LAGs) that share the same Broadcast domain (VLAN) with other interfaces.

For more information, see "Protected Ports" on page 388.

iSCSI Optimization

iSCSI optimization provides the iSCSI flows with specific priority over other network traffic. In addition, the feature provides monitoring of iSCSI sessions.

For more information, see "iSCSI Optimization" on page 584.

Proprietary Protocol Filtering

This feature enables user control over the filtering of packets with proprietary protocols such as CDP, VTP, DTP, UDLD, PaGP, and SSTP. The user can select any combination of the protocols to be filtered, for example: CDP and VTP and UDLD.

For more information, see "Network Security" on page 92.

DHCP Relay and Option 82

A DHCP relay agent detects DHCP Broadcasts from DHCP clients and relays them to DHCP servers that may reside on different subnets.

The relay agent information option (Option 82) in the DHCP protocol enables a DHCP relay agent to send additional client information, upon requesting an IP address.

Option 82 specifies the relaying switch's MAC address, the port identifier, and the VLAN that forwarded the packet.

For more information, see "DHCP Relay" on page 577.

Identifying a Switch via LED

The switch provides the ability to turn on a LED (through the GUI interface) on a specific unit or on all units in a stack for a specific length of time.

For more information, see Unit Identification (Location).

Hardware Description

This section describes PowerConnect 5500 hardware.

It contains the following topics:

- Device Models
- Device Structure
- LED Definitions
- Power Supplies

Device Models

The PowerConnect 5500 switches combine versatility with minimal management requirements. This series includes the following device types:

- **PowerConnect 5524** — Provides 24 10/100/1000Mbps Base-T ports
- **PowerConnect 5524P (with PoE)** — Provides 24 10/100/1000Mbps Base-T ports, along with Power-over-Ethernet (PoE) support
- **PowerConnect 5548** — Provides 48 10/100/1000Mbps Base-T ports
- **PowerConnect 5548P (with PoE)** — Provides 24 10/100/1000Mbps Base-T ports, along with Power-over-Ethernet (PoE) support

Each of these devices provides, in addition to the above ports, two HDMI ports, two SPF+ ports, an RS-232 console port, and a USB port, as shown in Figure 5-1.

 **NOTE:** 10/100/1000Mbps Base-T ports are also known as Gigabit ports or G ports.

Device Structure

This section describes the structure of the devices.

It contains the following topics:

- Front Panel
- Buttons and LEDs
- Back Panel
- Ventilation System
- System LEDs
- Port LEDs

Front Panel

Figure 5-1 shows the front panel of the PowerConnect 5548 device with its various ports labelled. The PowerConnect 5524 device from the PowerConnect 5548 device in that there are 24 G ports and not 48.

Figure 5-2 shows the buttons/LEDs on the right side in greater detail.

Figure 3-1. PowerConnect 5548 Ports

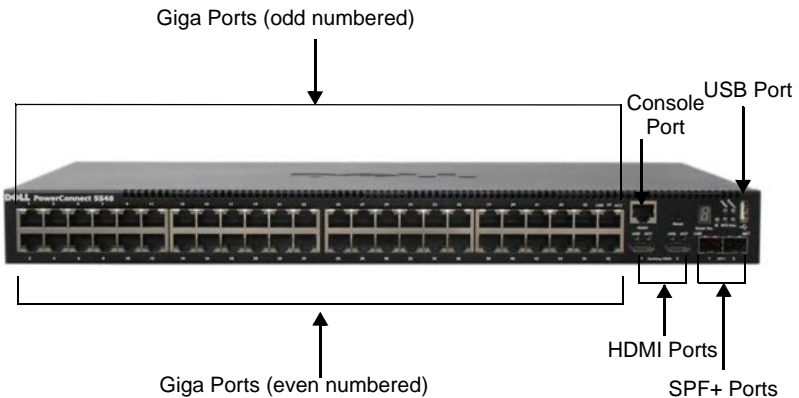

The following ports are found on the devices.

- **24/48 G Ports**
- **Two XG Ports** (also known as Small Form Factor Pluggable (SFP) + Ports)
These are 10 Gigabit ports, designated as 1000Base-X-SFP+. The SFP+ ports are fiber transceivers designated as 10000 Base-SX or LX. They include TWSI (Two-Wire Serial Interface) and internal EPROM.
- **RS-232 Console Port**
This port is used for a terminal connection for debugging and software downloads. The default baud rate is 9,600 bps. The baud rate can be configured from 2400 bps up to 115,200 bps.
- **Two HDMI Ports**
The HDMI ports are 1.3a specification, category 2 high-speed cables, 340 MHz (10.2 Gbit/s). They are used for stacking purposes.

NOTE: it is recommended to use HDMI cable version 1.4

- **Single USB Port**

This port is used for firmware upgrade from a USB device.

Buttons and LEDs

LEDs on Front Panel

Figure 5-2 shows the extreme, right-hand part of the front panel, which contains buttons and LEDs, in addition to ports.

Figure 3-2. Button/LED Panel

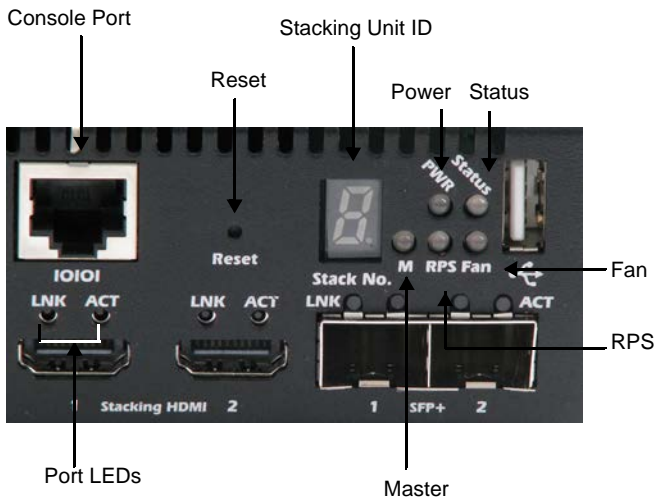

These LEDs are described in Table 5-1 and Table 5-2.

Reset Button

The PowerConnect 5500 switches have a reset button, located on the front panel that is used for manual reset (reboot) of the device.

The single reset circuit of the switch is activated by power-up or low-voltage conditions.

The Reset button does not extend beyond the unit's front, and it must be activated with a pin.

Back Panel

The back panel of the non-PoE models, shown in Figure 5-3, contains a Redundant Power Supply (RPS) connector, Location LED, and power connector.

The back panel of the PoE models, shown in Figure 5-4, contains a Modular Power Supply (MPS) connector, Location LED, power connector, and two fan outlets.

Figure 3-3. PowerConnect 5524/48 Back Panel



Figure 3-4. PowerConnect 5524/48/P Back Panel

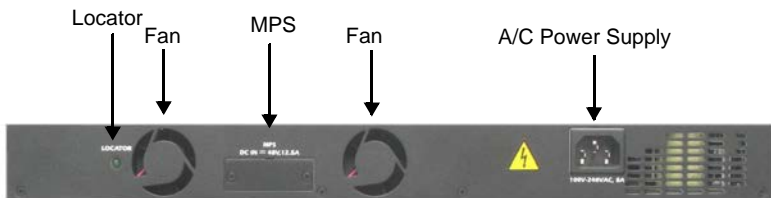

The elements on the back panel are used as follows:

- **Locator LED** — This LED is lit when the Unit Identification feature is selected. See "Unit Identification (Location)" on page 367 for more information about this feature.
- **RPS/MPS** — Connector for auxiliary power supply. See "Power Supplies" on page 42 for more information.

- **A/C Power Supply** — Connector for AC power supply. See "Power Supplies" on page 42 for more information.
- **Fans** — Fan outlets. See "Ventilation System" on page 38 for more information.

Ventilation System

The PowerConnect 5500/P switches have two built-in fans. Operation can be verified by observing the LED that indicates if one or more fans are faulty (see Table 5-1).

The fan outlets are shown in Figure 5-4.

LED Definitions

The front panel contains light emitting diodes (LEDs) that indicate the status of links, power supplies, fans, and system diagnostics.

These are described below.

System LEDs

The system LEDs of the PowerConnect 5500 devices provide information about the power supplies, fans, thermal conditions, and diagnostics.

Figure 5-2 shows the location of the system LEDs on the device.

Table 5-1 describes the meaning of the colors of the system LEDs.

Table 3-1. System LED Indicators

LED	Color	Description
Power Supply (PWR)	Green Static	The switch is turned on.
	Green Flashing	The Locator function is enabled.
	Off	The switch is turned off.
Status	Green Static	The switch is operating normally.
	Green Flashing	The switch is booting.
	Red Static	A critical system error has occurred.
	Red Flashing	A non-critical system error has occurred.

Table 3-1. System LED Indicators (Continued)

LED	Color	Description
Stacking No.		Indicates the unit ID of the device in the stack.
Modular/Redundant Power Supply (MPS/RPS)	Green Static	The MPS/RPS is currently operating.
	Red Static	The MPS/RPS failed.
	Off	The MPS/RPS is not plugged in.
Locator	Green Flashing	Locator function is enabled.
	Green Static	Locator function is disabled.
Master	Green Static	The device is a master unit.
	Off	The device is not a master unit.
Fan (FAN)	Green Static	All device fans are operating normally.
	Red Static	One or more of the device fans are not operating.

Port LEDs

Gigabit Ports

Each Giga port has two LEDs associated with it. The speed/link (LNK) LED is located on the left side of the port, while the activity/PoE LED is located on the right side of the port. The activity/PoE LED is labelled ACT in non-PoE devices, and is labelled PoE in PoE-enabled devices, as shown in Figure 5-5.

Figure 3-5. Giga Port LEDs

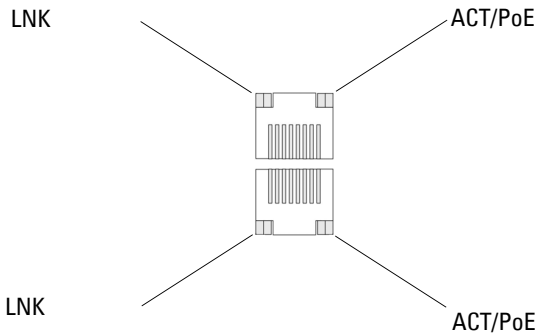

Table 5-2 describes the LED indications for the Gigabit ports:

Table 3-2. Giga Port s on non-PoE-enabled Devices LEDs

LED	Color	Description
LNK	Green Flashing	Link is up and the port is either transmitting or receiving at 1000 Mbps.
	Yellow Flashing	Link is up and the port is either transmitting or receiving data at 100 Mbps.
	Solid green	Link is up high speed.
	Solid amber	Link is up at lower speeds.
	OFF	The port is currently not operating.
ACT	Green Flashing	There is activity on the port.
	Off	There is no activity on the port.

Table 5-3 describes the LED indications for Gigabit ports on PoE-enabled devices.

Table 3-3. Giga Port s on PoE-enabled Devices LEDs

LED	Color	Description
LNK	Flashing green	Link is up and the port is either transmitting or receiving at 1000 Mbps.
	Flashing amber	Link is up and the port is either transmitting or receiving data at 100 Mbps.
	Solid green	Link is up high speed.
	Solid amber	Link is up at lower speeds.
	Off	Port is currently not operating.
PoE	Flashing green	There is activity on the port and the PoE is off.
	Flashing amber	There is activity on the port and the PoE is on.
	Amber solid	There is no activity on the port and the PoE power is on.
	Off	There is no activity on the port and the PoE is off.

HDMI Port LEDs

The HDMI ports have a Speed/link (LNK) LED on their left side and an activity (ACT) LED on their right side.

Table 5-4 describes the HDMP port LEDs:

Table 3-4. HDMI (Stacking) Port LEDs

LED	Color	Description
Speed/Link	Solid green	Port is linked to device.
	Off	Port is currently not operating.
ACT	Flashing green	Port is either transmitting or receiving.
	Off	Port is not transmitting or receiving.

SFP LEDs

The SFP+ ports each have two LEDs, marked as LNK and ACT, associated with them. Figure 5-5 describes these LEDs.

Table 3-5. SFP Port LEDs

LED	Color	Description
LNK	Solid green	Link is at highest speed.
	Solid amber	Link is at lowest speed.
	Off	Port is currently not linked.
ACT	Flashing green	Port is either transmitting or receiving.

Stack ID LED

The front panel of the device contains a Stack ID panel used to display the Unit ID for the Stack Master and members, as shown in Figure 5-2.

Power Supplies

The device has an internal power supply unit (AC unit) and a connector to connect PowerConnect 5500/P devices to a PowerConnect EPS-470 unit, or to a PowerConnect MPS-600 unit.

The PowerConnect 5500/P devices have the following internal power supplies:

- 24 Port non-PoE devices — 54 Watt.
- 48 Port non-PoE devices — 100 Watt.
- 24/48 Port PoE devices — 600 Watt.

Operation with both power supply units is regulated through load sharing. Power supply LEDs indicate the status of the power supply.

The AC power supply unit operates from 90 to 264 VAC, 47 to 63 Hz. The AC power supply unit uses a standard connector. A LED, shown in Figure 5-3, indicates whether the AC unit is connected.

When the device is connected to a supplementary power source, the probability of failure in the event of a power outage decreases.

Stacking Overview

This section describes how the Stacking feature of the PowerConnect 5500 series functions.

It contains the following topics:

- Stack Overview
- Stack Members and Unit IDs

Stack Overview

The PowerConnect 5500 Stacking feature provides multiple switch management through a single switch, so that all units in the stack are treated as if they were a single switch. All stack members are accessed through the management IP address, through which the stack is managed.

Each switch is a member in a stack, although the stack may consist of only a single switch.

Up to eight units can be stacked.

This section covers the following topics:

- Stack Operation Modes
- Stacking Units
- Stack Topology

Stack Operation Modes

All stacks must have a Master unit, and may have a Master Backup unit. All other units are connected to the stack as members (slaves).

A unit in the stack can be in one of the following modes:

- **Stack Master** — Runs the fully operational software of a switch. In addition, it runs configures and manages all other units in the stack. All protocols run in the context of the Master unit. It is responsible for updating and synchronizing the Master Backup.

The Stack Master detects and reconfigures the ports with minimal operational impact in the event of:

Unit failure

Inter-unit stacking link failure

Unit insertion

Unit removal

When the Master unit boots, or when inserting or removing a stack member, the Master unit initiates a stacking discovering process.

- **Slave Unit** — Runs a slave version of the software that enables the applications running on the Master's CPU to control and manage the resources of the slave unit.
- **Master Backup** — Runs as a slave unit, as described above, and in addition, continuously monitors the existence and operation of the stack master. If the master unit fails, the master-backup unit assumes the Master Backup role.

Stacking Units

PowerConnect 5500 series switches use two HDMI 10G ports for stacking.

To connect the units in the stack:

- 1** Insert one end of an HDMI cable into the left-hand HDMI port on the unit at the top of the stack and the other end into the right-hand HDMI port of the unit immediately below it (this is called crossover).
- 2** Repeat this process until all units are connected.
- 3** (Optional) Connect the left-hand HDMI port of the unit at the bottom of the stack to the right-hand HDMI port of the unit at the top of the stack. This step provides increased bandwidth and redundancy.

The results of this process are shown in Figure .

Figure 4-1. Stacking Ring Topology

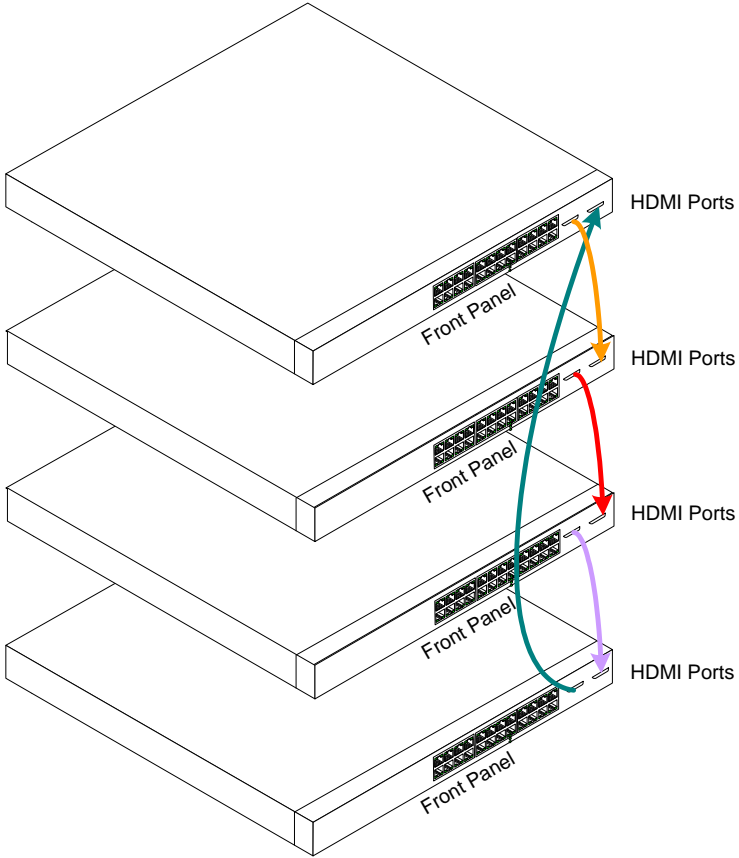

Stack Topology

The PowerConnect 5500 series systems operates in a ring or chain topology.

Ring Topology

In a ring topology all units in the stack are connected to each other, forming a circle. Each unit in the stack accepts data and sends it to the unit to which it is attached. The packet continues through the stack until it reaches its destination. The system discovers the optimal path on which to send traffic.

Figure shows units of a stack connected in a ring topology.

Stacking Failover Topology - Chain Topology

Difficulties occur when a unit in the ring becomes non-functional, or a link is severed. In this case, the system automatically switches to a chain topology, without any system downtime.

In chain topology, each unit in the stack is connected to neighboring unit except for the last unit, which is not connected to any other unit.

In the chain topology, the stack continues to function as long as there is a master- or backup-enabled unit in each segment of the stack.

When the ring topology is switched to chain topology, an SNMP message is automatically generated, but no stack management action is required. The unit that failed must be repaired to restore full stacking operation in the ring topology.

After the stacking issues are resolved, the units can be reconnected without interruption, and the ring topology is restored.

Stack Members and Unit IDs

This section describes how to configure the stack.

It contains the following topics:

- Adding a Unit to the Stack
- Assigning Unit IDs
- Selecting the Master and Master Backup Units
- Switching from the Master to the Master Backup
- Replacing Stacking Members

- Loading Software onto Stack Members
- Rebooting the Stack
- Managing Configuration Files on the Stack

Adding a Unit to the Stack

The recommended procedure to add a unit to a stack is as follows:

- 1** Place the powered-off unit in its physical place in the stack, and insert the stacking link in the unit (but do not connect it to the rest of the stack).
- 2** Power up the unit, and set the correct Unit ID, as described below.
- 3** Reboot the unit and connect it to the rest of the stack through the stack link.

Assigning Unit IDs

Each unit in the stack has a unique ID that defines the unit's position and function in the stack, as shown in Figure 5-2.

The unit that is assigned Unit ID 1 is the Master unit, by default. The unit that is assigned Unit ID 2 is the Master Backup unit.

When you power-up the stack, each unit is assigned a unique Unit ID. This is displayed on the front panel of the unit, as shown in Figure 5-2.

The Unit ID of each unit can be either automatically assigned or manually assigned, as described in step 1 to step 4 below.

To assign IDs to the units in the stack, do the following for each unit in the stack:

- 1** Connect the unit to the terminal.

- 2 Turn on the unit to begin auto boot and press **Return** or **Esc** to abort and enter the **Start Up** menu.

```
Startup Menu
[1]Download Software
[2]Erase Flash File
[3>Password Recovery Procedure
[4]Set Terminal Baud-Rate
[5]Stack Menu
[6]Back
```

- 3 Select **Stack Menu** to open the **Stack Menu**.

```
[1]Show Unit Stack ID
[2]Set Unit Stack ID
[3]Back
```

- 4 Select **Set Unit Stack ID**. Enter either a Unit ID for manual assignment or 0 to indicate that the unit ID will be assigned automatically.





NOTE: The entire stack should be connected, as shown in Figure 6-1, before powering up the units.

Selecting the Master and Master Backup Units

A unit is master-enabled if it assigned Unit ID 1 and Unit 2. All other units in the stack (slaves) have unit IDs of 3-8.

The stack master assignment is performed during the configuration boot process. One master-enabled stack member is elected as Master, and the other master-enabled stack member is selected as Master Backup, according to the following decision process:

- A master is selected from the set of the two Master-enabled units. Priority is given to the lowest unit ID, but also takes into account the amount of time the unit is UP (Up Time) as follows:

- When a master-enabled unit is inserted to a running stack, (or when Master and Backup master both start at the same time), they exchange each other's UP TIME (the time since they powered up). If the time difference is smaller than 10 minutes, the unit with the lowest unit ID is elected; otherwise, the unit with the longest UP time is elected.
- If a Master-enabled unit (with ID 1 or 2) is inserted into an operational stack, it will be elected as a backup master.
- If a Master unit and/or a backup Master unit is removed from the stack and the user wishes to configure one of the slave units (numbered 3-8) to be a Master backup, the user must reset the unit's ID. This can be done as follows:
 - If there is a Master-enabled unit in the stack: Do **-switch n renumber 2** (through CLI or GUI). This makes the nth unit a master-enabled unit.
 - If there is no Master-enabled unit in the stack: Press the reset button on the unit to be master-enabled, and assign it a unit ID= 1 using the boot menu.
- The user can **force** a master-enabled unit to be the master unit of the stack, even if the master election process did not select it. This is done by switching over to the backup unit.
 -  **NOTE:** Two stacking member are considered the same age if they were inserted within a ten minute interval, for example, if Unit 2 is inserted in the first minute of a ten-minute cycle, and Unit 1 is inserted in fifth minute of the same cycle, the units are considered to be the same age.
 -  **NOTE:** If two stack members are discovered to have the same Unit ID, only the older unit is included in the stack. The stack continues to function and a message is sent notifying that a unit failed to join the stack.

The Stack Master and the Master Backup maintain a Warm Standby. The Warm Standby ensures that the Master Backup takes over for the Stack Master if a failover occurs, so that the stack continues to operate normally.

During the Warm Standby, the Master and the Master Backup are synchronized with the static configuration. When the Stacking Master is configured, it must synchronize the Master Backup. The dynamic

configuration is not saved, for example, dynamically-learned MAC addresses are not saved, but dynamic information is learned quickly and automatically by network traffic.

Switching from the Master to the Master Backup

The Master Backup replaces the Stack Master if one or more of the following events occur:

- The Stack Master fails or is removed from the stack.
- Links from the Stack Master to the stacking members fails.
- User performs soft switchover via the Web interface or the CLI.

Switching between the Stack Master and the Master Backup results in limited service loss. Dynamic tables are relearned if a failure occurs. The Running Configuration file is synchronized between Stack Master and the Master Backup, and continues running on the Master Backup.

Replacing Stacking Members

If a unit is removed from the stack, and replaced with a unit with the same unit ID, the stack member is configured with the original unit configuration.

Otherwise, if the new unit has either more or fewer ports than the previous unit, the results depend on the device type of the new and original units, as defined in Table 6-1:

Table 4-1. Port Configurations when Replacing Units

New Unit	Original Unit	New Port Configuration
5548P or 5548	5548P or 5548	Port configurations remain the same.
	5524 or 5524P	The first 24 Giga (GE) ports receive the respective 5524/P 24 GE port configurations. The 10 G port configurations remain the same.

Table 4-1. Port Configurations when Replacing Units (Continued)

New Unit	Original Unit	New Port Configuration
5524P or 5524	5548P or 5548	The PowerConnect 5524/P 24 Gigabit ports receives the first 24 Giga 5548/P port configurations. The 10 Giga port configurations remain the same. The remaining ports receive the default port configuration.
	5524P or 5524	Port configurations remain the same.

Loading Software onto Stack Members

Software can be downloaded to all units simultaneously, or to the master unit alone. If software is only loaded to the master unit, when new software is selected, and the Master is rebooted, the Master updates the software on the remaining units.

In this way, all units in the stack run the same software version.

Rebooting the Stack

Whenever a reboot occurs, topology discovery is performed, and the Master learns all units IDs in the stack.

Configuration files are changed only through explicit user configuration, and are not automatically modified when units are added, removed or reassigned unit IDs.

Each time the system reboots, the Startup Configuration file in the Master unit is used to configure the stack.

Managing Configuration Files on the Stack

The Startup Configuration and Running Configuration file are stored on the stack master.

Each port in the stack is referenced in the configuration files by its port type and unit ID/0/port number, for example "gi1/0/24", which means Giga port 24 on unit 1 (the middle 0 is reserved for future use).

Configuration files are managed from the Stack Master, including:

- Saving to flash memory

- Uploading configuration files to an external TFTP server/HTTP client
- Downloading configuration files from an external TFTP server/HTTP client
- Download/upload through the USB port



NOTE: Stack configuration for all configured ports is saved, even if the stack is reset and/or the ports are no longer present.

Configuring the Switch

This section describes the configuration that must be performed after the switch is installed and connected to power supplies. Additional advanced functions are described in "Advanced Switch Configuration" on page 63.



NOTE: Before proceeding further, read the release notes for this product. You can download the release notes from the Dell Support website at support.dell.com.



NOTE: We recommend that you obtain the most recent revision of the user documentation from the Dell Support website at support.dell.com.

It contains the following topics:

- Configuration Work Flow
- Connecting the Switch to the Terminal
- Booting the Switch
- Configuring the Stack
- Configuration Using the Setup Wizard

Configuration Work Flow

To configure the switches:

- 1** For each switch in the stack:
 - a** Connect it to a terminal, as described in the "Connecting the Switch to the Terminal" on page 56.
 - b** Boot the switch, as described in the "Booting the Switch" on page 57.
 - c** Assign a unit ID to the switch, as described in "Assigning Unit IDs" on page 48.
- 2** Connect the units in the stack to each other, as described in "Configuring the Stack" on page 58.
- 3** Connect the Master unit to the terminal, reboot the unit and the Setup Wizard is run automatically, as described in "Configuration Using the Setup Wizard" on page 58.
- 4** Respond to the Setup Wizard prompts.
- 5** Continue managing the switch, either through the console or Telnet, using the CLI or the web GUI.

Connecting the Switch to the Terminal

The switch is configured and monitored through a terminal desktop system that runs terminal emulation software. The switch connects to the terminal through the console port.

To connect the switch to a terminal:

- 1 Connect an RS-232 cable to a VT100-compatible terminal or the serial connector of a desktop system running terminal emulation software.
- 2 Connect the RS-232 cable to the switch console port on the front panel of the switch (see Figure 7-1) using an 8-pin RJ-45 male connector.

Figure 5-1. Front-Panel Console Port



- 3 Set the terminal emulation software as follows:
 - a Select the appropriate serial port to connect to the switch.
 - b Set the data rate to 9600 baud.
 - c Set the data format to 8 data bits, 1 stop bit, and no parity.
 - d Set Flow Control to *none*.
 - e Select VT100 for Emulation mode within your communication software.
 - f Select Terminal keys for Function, Arrow, and Ctrl keys. Ensure that the setting is for Terminal keys (*not* Windows keys).



NOTE: You can connect a console to the console port on any unit in the stack, but stack management is performed only from the stack master (Unit ID 1 or 2).

Booting the Switch

After the local terminal is connected, turn on power. The switch then goes through power-on self-test (POST). POST runs every time the switch is started and checks hardware components, to determine if the switch is operational before completely booting. If the system detects a critical problem, the boot process stops. If POST passes successfully, a valid executable image is loaded into RAM. POST messages are displayed on the terminal and indicate test success or failure.

The boot process runs for approximately 40-45 seconds.

When the boot process completes, the following LEDs are lit, as shown in Figure 7-2:

- Power
- Status
- Fan (should be green)
- RPS (if it is being used)

Figure 5-2. Initial LEDs

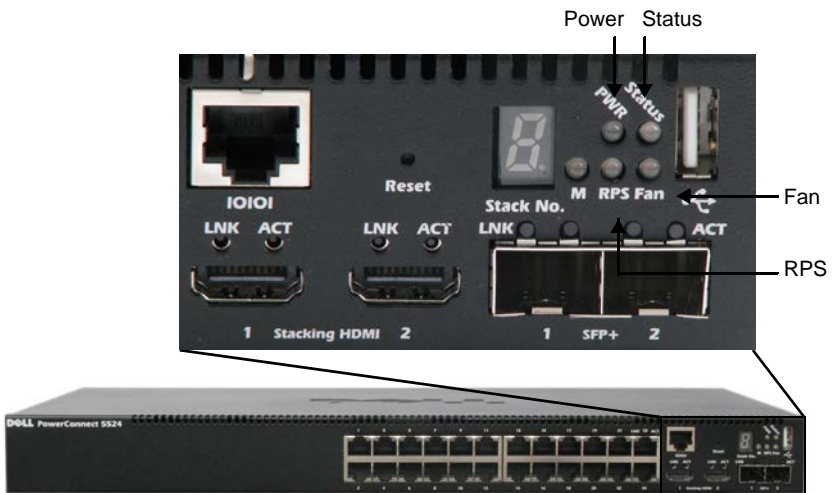

Configuring the Stack

The switch is always considered to be a stack of switches even if the stack only contains a single switch. If there is more than one switch in the stack, each switch must be configured individually. See "Assigning Unit IDs" on page 48 for instructions on how to configure the stack.

Configuration Using the Setup Wizard

The Setup Wizard guides you through the initial switch configuration to get the system up and running as quickly as possible. Note that you can skip the Setup Wizard and configure the switch manually through the CLI.

The Setup Wizard configures the following fields:

- SNMP Community String and SNMP Management System IP address (optional)
- Username and password
- Management switch IP address
- IP subnet mask
- Default gateway IP address



NOTE: The Setup Wizard assumes the following:

- The PowerConnect switch was never configured before and is in the same state as when you received it.
- The PowerConnect switch booted successfully.
- The console connection is established and the console prompt is displayed on the screen of a VT100 terminal switch.

Connect the Master unit to a terminal. You can identify the Master unit by the illuminated Master LED on the front panel of the switch (see Figure 5-2).

To configure the system using the Setup Wizard:

- 1 Obtain the following information from the network administrator:
 - SNMP Community String and SNMP Management System IP address (optional)
 - Username and password

- The IP address to be assigned to the VLAN 1 interface through which the switch is to be managed (by default, every external and internal port is a member of the VLAN 1)
 - The IP subnet mask for the network
 - The default gateway (next hop router) IP address for configuring the default route
- 2** Boot the Master unit. The system automatically prompts you to use the Setup Wizard.

The Setup Wizard displays the following information:

```
Welcome to Dell Easy Setup Wizard
```

```
The Setup Wizard guides you through the initial switch configuration and gets you up and running easily and quickly. You can skip the Setup Wizard and enter CLI mode to manually configure the switch. The system will prompt you with a default answer; by pressing Enter, you accept the default value.
```

```
You must respond to the next question to run the Setup Wizard within 60 seconds, otherwise the system will continue with normal operation using the default system configuration.
```

```
Would you like to enter the Setup Wizard (you must answer this question within 60 seconds)? (Y/N)
```

- 3** Enter [Y] to run the wizard. If you enter [N] or if you do not respond within 60 seconds, the Setup Wizard automatically exits and the CLI console prompt appears.

If you enter [Y] the wizard provides interactive guidance through the initial switch configuration.

The following information is displayed:

```
You can exit the Setup Wizard at any time by entering [ctrl+Z].
```

```
The system is not set up for SNMP management by default.
```

To manage the switch using SNMP (required for Dell Network Manager) you can:

- Setup the initial SNMP version 2 account now.
- Return later and set up the SNMP version account. For more information on setting up a SNMP version 2 account, see the user documentation.

Would you like to set up the SNMP management interface now? [Y/N]

- 4 Enter [N] to skip to Step 7 or enter [Y] to continue the Setup Wizard. If you enter [Y] the following information is displayed:

To set up the SNMP management account you must specify the management system IP address and the "community string" or password that the particular management system uses to access the switch. The wizard automatically assigns the highest access level [Privilege Level 15] to this account.

You can use Dell Network Manager or other management interfaces to change this setting later and to add additional management system later. For more information on adding management systems, see the user documentation.

To add a management station:

Please enter the SNMP community string to be used:

- 5 Enter the SNMP community string. You can use the default name "public"

Please enter the IP address of the Management System (A.B.C.D) or wildcard (0.0.0.0) to manage from any Management Station:[0.0.0.0].

- 6 Enter the SNMP Management System IP.

- 7 Set up user account privilege level, as follows:

The following information is displayed:

Now we need to set up your initial privilege (Level 15) user account. This account is used to login to the CLI and Web interface. You may set up

other accounts and change privilege levels later. For more information on setting up user accounts and changing privilege levels, see the user documentation.

To set up a user account:

Enter the user name:

Please enter the user password:

Please reenter the user password:

8 Enter the following:

- User name, for example "admin"
- Password and password confirmation.

9 Press **Enter**.

The following information is displayed:

Next, an IP address is setup. The IP address is defined on the default VLAN (VLAN 1). This is the IP address you use to access the Telnet, Web interface, or SNMP interface for the switch.

To set up an IP address:

Please enter the IP address of the device (A.B.C.D):

Please enter the IP subnet mask (A.B.C.D or nn):

10 Enter the management IP address and IP subnet mask, for example 192.168.2.100 as the IP address and 255.255.255.0 as the IP subnet mask.

11 Press **Enter**.

The following information is displayed:

Finally, set up the default gateway.

Please enter the IP address of the gateway from which this network is reachable (e.g. 192.168.2.1).Default gateway (A.B.C.D):[0.0.0.0]

12 Enter the default gateway.

13 Press **Enter**. The following is displayed (example):

This is the configuration information that has been collected:

```
SNMP Interface = "Dell Network  
Manager"@192.168.2.10
```

```
User Account setup = admin
```

```
Password = *****
```

```
Management IP address = 192.168.2.100  
255.255.255.0
```

```
Default Gateway = 192.168.2.1
```

The following information is displayed:

If the information is correct, please select (Y) to save the configuration and copy to the start-up configuration file. If the information is incorrect, select (N) to discard configuration and restart the wizard: [Y/N]

14 Enter [N] to restart the wizard or enter [Y] to complete the Setup Wizard. If you enter [Y] the following is displayed:

```
Configuring SNMP management interface.
```

```
Configuring user account.....
```

```
Configuring IP and subnet.....
```

```
Thank you for using Dell Easy Setup Wizard. You  
will now enter CLI mode.
```

The CLI prompt is displayed. You have finished the initial configuration.

After the initial configuration is complete, you can manage the switch from the connected console port using the CLI or remotely through the management interface, using Telnet or the Web GUI. See the *Dell PowerConnect 5500 Series User Guide* found on the Documentation CD.

Advanced Switch Configuration

This section describes how to perform various configuration operations through the CLI.

It includes the following topics:

- Using the CLI
- Accessing the Device Through the CLI
- Retrieving an IP Address
- Security Management and Password Configuration
- Configuring Login Banners
- Startup Menu Procedures
- Software Download

Using the CLI

This section provides some general information for using the CLI.

For a complete description of CLI commands, refer to the Dell PowerConnect 55xx Systems *CLI Reference Guide*.

Command Mode Overview

The CLI is divided into command modes, each with a specific command set. Entering a question mark at the terminal prompt displays a list of commands available for that particular command mode.

In each mode, a specific command is used to navigate from one mode to another.

These modes are described below.

User EXEC Mode

During CLI session initialization, the CLI is in User EXEC mode. Only a limited subset of commands is available in User EXEC mode. This level is reserved for tasks that do not change the terminal configuration and is used to access configuration sub-systems.

After logging into the device, User EXEC command mode is enabled. The user-level prompt consists of the host name followed by the angle bracket (>). For example: `console>`



NOTE: The default host name is `console` unless it has been modified during initial configuration.

The User EXEC commands enable connecting to remote devices, changing terminal settings on a temporary basis, performing basic tests, and listing system information.

To list the User EXEC commands, enter a question mark at the command prompt.

To enter the next level, Privileged EXEC mode, a password is required (if configured).

Privileged EXEC Mode

Privileged EXEC mode provides access to the device global configuration.

Privileged access can be protected, to prevent unauthorized access and to secure operating parameters. Passwords are displayed on the screen, and are case-sensitive.



NOTE: The `enable` command is only necessary if you login with privilege level less than 15.

To access and list the Privileged EXEC mode commands:

- 1 At the prompt type `enable` and press `<Enter>`.
- 2 When a password prompt displays, enter the password and press `<Enter>`.

The Privileged EXEC mode prompt displays as the device host name followed by `#`. For example: `console#`

To list the Privileged EXEC commands, type a question mark at the command prompt.

To return from Privileged EXEC mode to User EXEC mode, type `disable` and press `<Enter>`.

The following example illustrates accessing privileged EXEC mode and then returning to the User EXEC mode:

```
console> enable
Enter Password: *****
console#
console# disable
console>
```

Use the `exit` command to return to a previous mode.

To configure the device, enter the next level, Global Configuration mode.

Global Configuration Mode

The Global Configuration mode manages device configuration on a global level. Global Configuration commands apply to system features, rather than a specific protocol or interface.

To access Global Configuration mode, at the Privileged EXEC Mode prompt, type **configure** and press <Enter>. The Global Configuration mode displays as the device host name followed by (**config**) and the pound sign **#**.

```
console# configure  
console(config)#
```

To list the Global Configuration commands, enter a question mark at the command prompt.

The following example illustrates how to access Global Configuration mode and return back to the Privileged EXEC mode:

```
console#  
console# configure  
console(config)# exit  
console#
```

Interface Configuration Mode

The Interface Configuration mode configures the device at the physical interface level (port, VLAN, or LAG). Interface commands that require subcommands have another level, called the Subinterface Configuration mode. A password is not required to access this level.

The following example, places the CLI in Interface Configuration mode on port 1/0/1. The **sntp** command is then applied to that port.

```
console# configure  
console(config)# interface gil1/0/1  
console(config-if)# sntp client enable
```

To run a command in a mode, which does not contain it, use **do** before the command, as in the following example:

```
console# configure  
console(config)# interface gil1/0/1  
console(config-if)# sntp client enable  
console(config-if)# do show sntp configuration
```

Accessing the Device Through the CLI

You can manage the device using CLI commands, over a direct connection to the terminal console, or via a Telnet connection.

Direct Connection

Connect the device to the console and enter the CLI commands upon receiving a prompt.

Telnet Connection

Telnet is a terminal emulation TCP/IP protocol. RS-232 terminals can be virtually connected to the local device through a TCP/IP protocol network. Telnet is an alternative to a local login terminal, where a remote login is required.

The device supports up to four simultaneous Telnet sessions. All CLI commands can be used over a Telnet session.

If access is via a Telnet connection, ensure that the device has an IP address and that software has been downloaded to the device.

To start a Telnet session:

- 1 Select **Start > Run**.

The **Run** window opens.

- 2 Type **cmd**.

The **cmd** window opens.

- 3 In the **cmd** window, type **Telnet <IP address> <Enter>**.

The Telnet session begins.

Retrieving an IP Address

Receiving an IP Address from a DHCP Server

When using the DHCP protocol to retrieve an IP address, the device acts as a DHCP client. When the device is reset, the DHCP command is saved in the configuration file, but the IP address is not.

To retrieve an IP address from a DHCP server, perform the following steps:

- 1 Select and connect any port to a DHCP server or to a subnet that has a DHCP server on it.
- 2 Type the following commands to use the selected port for receiving the IP address.
 - a Assigning dynamic IP Addresses on a port:

```
console# configure  
console(config)# interface gi1/0/1  
console(config-if)# ip address dhcp
```

- b Assigning a dynamic IP Addresses on a VLAN:

```
console# configure  
console(config)# interface vlan 1  
console(config-if)# ip address dhcp
```

The interface receives the IP address automatically.

- 3 To verify the IP address, type **show ip interface** at the system prompt, as shown in the following example.

```
console# show ip interface
```

IP Address	I/F	Type	Directed Broadcast	Precedence	Status
0.0.0.0/32	gi2/0/1	DHCP	disable	No	Valid
10.5.234.232/24	vlan 1	Static	disable	No	Valid

When configuring/receiving IP addresses through DHCP and BOOTP (an older version of DHCP), the configuration received from these servers includes the IP address and may include the subnet mask and default gateway.



NOTE: It is not necessary to delete the device configuration to retrieve an IP address from the DHCP server.



NOTE: When copying configuration files, avoid using a configuration file that contains an instruction to enable DHCP on an interface that connects to the same DHCP server, or to one with an identical configuration. In this instance, the device retrieves the new configuration file and boots from it. The device then enables DHCP, as instructed in the new configuration file, and the DHCP instructs it to reload the same file.



NOTE: If you configure a DHCP IP address, this address is dynamically retrieved, and the **ip address dhcp** command is saved in the configuration file. In the event of master failure, the backup will again attempt to retrieve a DHCP address. This could result in one of the following:

- The same IP address may be assigned.
- A different IP address may be assigned, which could result in loss of connectivity to the management station.
- The DHCP server may be down, which would result in IP address retrieval failure, and possible loss of connectivity to the management station.

Receiving an IP Address From a BOOTP Server

The standard BOOTP protocol is supported and enables the device to automatically download its IP host configuration from any standard BOOTP server in the network. In this case, the device acts as a BOOTP client.

To retrieve an IP address from a BOOTP server:

- 1 Select and connect any port to a BOOTP server or subnet containing such a server.
- 2 At the system prompt, enter the **delete startup configuration** command to delete the Startup Configuration from flash.

The device reboots with no configuration and in 60 seconds starts sending BOOTP requests. The device receives the IP address automatically.



NOTE: When the device reboot begins, any input at the ASCII terminal or keyboard automatically cancels the BOOTP process before completion and the device does not receive an IP address from the BOOTP server.

The following example illustrates the process:

```
console> enable
console# delete startup-config
Startup file was deleted
console# reload
You haven't saved your changes. Are you sure you want to
continue (Y/N) [N]?
This command will reset the whole system and disconnect
your current session. Do you want to continue (Y/N) [N]?
*****
/* the device reboots */
```

To display the IP address, enter the **show ip interface** command.

The device is now configured with an IP address.

Security Management and Password Configuration

System security is handled through the Authentication, Authorization, and Accounting (AAA) mechanism that manages user access rights, privileges, and management methods. AAA uses both local and remote user databases. Data encryption is handled through the SSH mechanism.

Passwords can be configured for the following services:

- Terminal
- Telnet
- SSH
- HTTP
- HTTPS



NOTE: When creating a user name, the default priority is 1, which provides access but not configuration rights. A priority of 15 must be set to enable access and configuration rights to the device. Although user names can be assigned privilege level 15 without a password, it is recommended to always assign a password. If there is no specified password, privileged users can access the Web interface with any password.



NOTE: Passwords can be secured by using password management commands to force aging out of passwords, or expiration of passwords. For more information, see "Management Security" on page 254.

Initial Configuration and Password Recovery

The system is delivered without a default password, and all passwords must be defined by the user. If a user-defined password is lost, a password recovery procedure can be invoked from the **Startup** menu. This procedure is applicable for the local terminal only and enables a single access to the device from the local terminal with no password entered.

The full mode of password recovery mechanism can be enabled/disabled through the CLI (service password-recovery command).

This affects password recovery in the following way:

- **Enabled:** When the password-recovery mechanism is invoked, one-time access to the device without a password is enabled and all configuration and user files are retained.

- **Disabled:** When the password-recovery mechanism is invoked, one-time access to the device without a password is still enabled, however all configuration files (startup and backups) are removed and the following log message is generated to the terminal after boot process completed: “All configuration and user files were removed”

Configuring an Initial Terminal Password

To configure an initial terminal password, enter the following commands:

```
console(config)# aaa authentication login default line
console(config)# aaa authentication enable default line
console(config)# line console
console(config-line)# login authentication default
console(config-line)# enable authentication default
console(config-line)# password george
```

Configuring an Initial Telnet Password

To configure an initial Telnet password, enter the following commands:

```
console(config)# aaa authentication login default line
console(config)# aaa authentication enable default line
console(config)# line telnet
console(config-line)# login authentication default
console(config-line)# enable authentication default
console(config-line)# password bob
```

Configuring an Initial SSH Password

To configure an initial SSH password, enter the following commands:

```
console(config)# aaa authentication login default line  
console(config)# aaa authentication enable default line  
console(config)# line ssh  
console(config-line)# login authentication default  
console(config-line)# enable authentication default  
console(config-line)# password jones
```

Configuring an Initial HTTP Password

To configure an initial HTTP password, enter the following commands:

```
console(config)# ip http authentication aaa login-  
authentication local  
console(config)# username admin password user1 privilege  
15
```

Configuring an Initial HTTPS Password

To configure an initial HTTPS password, enter the following commands:

```
console(config)# ip http authentication aaa login-  
authentication local  
console(config)# username admin password user1 privilege  
15
```

Enter the following commands once when configuring use of a terminal, a Telnet, or an SSH session, for an HTTPS session.



NOTE: In the Web browser, enable SSL 2.0 or greater for the page content to be displayed.

```
console(config)# crypto certificate 1 generate key-  
generate  
console(config)# ip http secure-server
```



NOTE: HTTP and HTTPS services require privilege level 15 access and connect directly to the configuration level access.

Configuring Login Banners

Banners can be defined for each line, such as console and telnet) or for all lines. They are disabled by default.

The following types of banners can be defined:

- **Message-of-the-Day Banner (motd)** — Displayed when the user connects to the device, before login. The following defines a message-of-the-day for the console:

```
console# configure
console(config)# line console
console(config-line)# motd-banner
console(config-line)# exit
console (config)# banner motd *
Welcome*
console# do show banner motd
Welcome
Would you like to enable this banner to all lines?
(Y/N)[Y] Y
console(config)#
```

- **Login Banner** — Displayed after the Message-of-the-Day Banner, and before the user has logged in. The following defines a login banner for the console:

```
console# configure
console(config)# line console
console(config-line)# login-banner
console(config-line)# exit
console (config)# banner login *
Please log in*
console# do show banner login
Would you like to enable this banner to all lines?
(Y/N)[Y] Y
Please log in
```

- **Exec Banner** — Displayed after successful login (in all privileged levels and in all authentication methods). The following defines an exec banner for the console:

```
console# configure
console(config)# line console
console(config-line)# exec-banner
console(config-line)# exit
console (config)# banner exec *
Successfully logged in*
Would you like to enable this banner to all lines?
(Y/N)[Y] Y
console# do show banner exec
Successfully logged in
```

Startup Menu Procedures

The **Startup** menu enables performing various tasks, such as software download, flash handling and password recovery.

You can enter the **Startup** menu when booting the device. User input must be entered immediately after the POST test.

To enter the **Startup** menu:

- Turn the power on. After the auto-boot messages appear, the following menu is displayed:

```
Startup Menu
[1]Download Software
[2]Erase Flash File
[3]Password Recovery Procedure
[4]Set Terminal Baud-Rate
[5]Stack menu
[6]Back
```

The following sections describe the available Startup menu options.



NOTE: When selecting an option from the Startup menu, take time-out into account. If no selection is made within 10 seconds (default), the device times out. This default value can be changed through the CLI.

Download Software - Option [1]

The software download procedure is used to replace corrupted files or upgrade system software, when the device does not have IP connectivity or when both software images of the device are corrupted and therefore you cannot use the web-based management system.



NOTE: it is highly recommended that, before loading via xmodem, the baud rate of the device and terminal be set to 115200.

To download software through the Startup menu:

- 1 From the Startup menu, press [1]. The following prompt is displayed:

```

  Downloading code using XMODEM
  !!!!!!!!!!!!!!!!!!!!!!!!!!!!!!!!!!!!!!!

```

- 2 When using the HyperTerminal, click **Transfer** on the HyperTerminal Menu Bar and select **Send File**.
- 3 In the **Filename** field, enter the file path for the file to be downloaded.
- 4 Ensure that the Xmodem protocol is selected in the **Protocol** field.
- 5 Press **Send**. The software is downloaded.



NOTE: After software download, the device reboots automatically.

Erase FLASH File - Option [2]

In some cases, the device Startup Configuration file must be erased. If the configuration is erased, all parameters configured via CLI, web-management or SNMP must be reconfigured.

To erase the device configuration in the Startup Configuration file:

- 1 From the Startup menu, select [2]. The following message is displayed:

```
Warning! About to erase a Flash file.
```

```
Are you sure (Y/N)?
```

- 2 Press **Y**. The following message is displayed.

```
Write Flash file name (Up to 8 characters, Enter for none.):
```

- 3 Enter **config** ("config" is the standard name for the Startup configuration file although you can use any name).

The following is displayed:

```

File config (if present) will be erased after system
initialization
===== Press Enter To Continue =====

```

The configuration is erased when the system is reset.

Password Recovery - Option [3]

If a password is lost, the Password Recovery procedure can be called from the Startup menu. The procedure enables entry to the device a single time without entering a password.

To recover a lost password when entering the local terminal only:

- 1 From the **Startup** menu, select [3].
- 2 Continue the regular startup by logging in without a password.
- 3 Enter a new password or press 'ESC' to exit.



NOTE: To ensure device security, reconfigure passwords for applicable management methods.

Set Terminal Baud-Rate - Option [4]

To set the terminal baud-rate:

- 1 Type [4] and press <Enter>.
- 2 Enter the new baud rate. The following is displayed:

```
Set new device baud-rate: 38,400
```

Note that after this step, your terminal will no longer respond. Adjust your terminal speed to the configured one.

Stack Menu - Option [5]

To configure the stack, type [5] and press <Enter>.

For more information, see "Assigning Unit IDs" on page 48.

Software Download

This section contains instructions for downloading device software (system and boot images) through a TFTP server or USB port. The TFTP server must be configured before downloading the software.

Software Auto Synchron Stack

When several units are stacked, they must all run the same software version. When a new slave device is inserted into the stack, it is first checked for compatibility (meaning that the master can run firmware upgrade/downgrade to the slave unit), and if found compatible, its boot and image software versions are automatically updated with the Master's. If the slave is found not compatible, it is shutdown.

A SYSLOG message is sent when a master synchronizes a slave's software.

System Image Download

When the device boots, it decompresses the system image from the flash memory area and runs it. When a new image is downloaded, it is saved in the other area allocated for the other system image copy.

On the next boot, the device decompresses and runs the image from the currently active system image.

A system image can be downloaded through a USB port or a TFTP server.

To download the system image from a TFTP server, ensure that an IP address is configured on one of the device ports and pings can be sent to the TFTP server. In addition, ensure that the file to be downloaded is saved on the TFTP server.

To download a system image through the USB port or TFTP server:

- 1 Enter the **show version** command, to verify which software version is currently running on the device. The following is an example of the information that appears:

Unit	SW version	Boot version	HW version
2	1.0.0.24	1.0.0.11	
console#			

- 2 Enter the **show bootvar** command, to verify which system image is currently active. The following is an example of the information that is displayed:

```
console# show bootvar
```

Unit	Image	Filename	Version	Date	Status
2	1	image-1	1.0.0.13	04-Aug-2010 08:27:30	Active*
2	2	image-2	1.0.0.12	29-Jul-2010 17:02:26	Not active

```
console#
```

- 3 Enter the one of the following commands to copy a new system image to the current unit:

- **copy {tftp://|usb://}{tftp address}/{file name} image** (current unit)

or

To copy a new system image to all units in the stack:

- **copy tftp://{tftp address}/{file name} unit://*/image**

- 4 When the new image is downloaded, it is saved in the area allocated for the other copy of system image (image-2, as shown in the example). The following is an example of the information that appears:

```
console# copy tftp://176.215.31.3/file1.ros image
Accessing file 'file1' on 176.215.31.3
Loading file1 from 176.215.31.3:
!!!!!!!!!!!!!!!!!!!!!!!!!!!!!!!!!!!!!!!!!!!!!!!!!!!!!!!!!!!!
Copy took 00:01:11 [hh:mm:ss]
```

Exclamation symbols indicate that a copying process is in progress. Each symbol (!) corresponds to 512 bytes transferred successfully. A period indicates that the copying process is timed out. Many periods in a row indicate that the copying process failed.

- 5 Select the image for the next boot by entering the **boot system image-2** command. After this command, enter the **show bootvar** command to verify that the copy indicated as a parameter in the **boot system** command is selected for the next boot.

The following is an example of the information that appears:

```
console# boot system image-2
console# show bootvar
Images currently available on the Flash
Image-1 active
Image-2 not active (selected for next boot)
```

If the image for the next boot is not selected by entering the boot system command, the system boots from the currently active image.

- 6 Enter the **reload** command. The following message is displayed:

```
console# reload
This command will reset the whole system and
disconnect your current session. Do you want to
continue (y/n) [n]?
```

- 7 Enter **Y**. The device reboots.

Boot Image Download

Loading a new boot image from the TFTP server or USB port, updates the boot image. The boot image is loaded when the device is powered on. A user has no control over the boot image copies.

To download a boot image through the TFTP server:

- 1 Enter the **show version** command to verify which software version is currently running on the device. The following is an example of the information that appears:

```
console# show version
Unit  SW version          Boot version          HW version
-----
2     1.0.0.24              1.0.0.11
console#
```

- 2 Enter the **copy {tftp://|usb://}{tftp address}/{file name} boot** command to copy the boot image to the device. The following is an example of the information that appears:

```
console# copy tftp://50.1.1.7/contax-10014.ros image
01-Oct-2006 11:57:35 %COPY-I-FILECPY: Files Copy - source URL
tftp://50.1.1.7/contax-10014.ros destination URL flash://image
!!!!!!!!!!!!!!!!!!!!!!!!!!!!!!!!!!!!!!!!!!!!!!!!!!!!!!!!!!!!
01-Sep-2010 11:57:38 %INIT-I-Startup: Cold Startup
!!!!!!!!!!!!!!!!!!!!!!!!!!!!!!!!!!!!!!!!!!!!!!!!!!!!!!!!!!!!
01-Sep-2010 11:59:05 %COPY-N-: The copy operation was completed
successfully!
Copy: 5954757 bytes copied in 00:01:30 [hh:mm:ss]
```

- 3 Enter the **reload** command. The following message is displayed:

```
console# reload

This command will reset the whole system and
disconnect your current session. Do you want to
continue (Y/N) [N]?
```

- 4 Enter Y. The device reboots.

Using Dell OpenManage Administrator

This section provides an introduction to the Dell OpenManage Switch Administrator user interface.

It contains the following topics:

- Starting the Application
- Understanding the Interface
- Using the Switch Administrator Buttons
- Field Definitions
- Common GUI Features
- CLI Commands

Starting the Application

 **NOTE:** Before starting the application the IP address must be defined. For more information, see "Accessing the Device Through the CLI" on page 67.

- 1 Open a web browser.
- 2 Enter the device's IP address in the address bar and press <Enter>.
- 3 When the **Log In** window displays, enter a user name and password.

 **NOTE:** Passwords are both case sensitive and alpha-numeric.

- 4 Click OK.

The Dell OpenManage Switch Administrator home page displays.

Understanding the Interface

The home page contains the following views:

- **Tree view** — Located on the left side of the home page, the tree view provides an expandable view of the features and their components. The branches in the tree view can be expanded to view all the components under a specific feature, or retracted to hide the feature's components. By dragging the vertical bar to the right, the tree area can be expanded to display the full name of a component.
- **Device View** — Located in on the top center of the home page, the device view provides information about device ports, current configuration and status, table information, and feature components. For further information, see "Device Representation" on page 85
- **Components List** — Located in the bottom center of the home page, contains a list of the feature components. When a feature is expanded, the GUI page for that feature is displayed.
- **Information Buttons**— Located at the top of the home page, provide access to information about the device and access to Dell Support. For more information, see "Information Buttons" on page 87.

Device Representation

The home page contains a graphical representation of the units in the stack's front panels. Figure 9-1 displays the 5548 model, but the display for the other models are similar.

Figure 7-1. PowerConnect Device Port Indicators

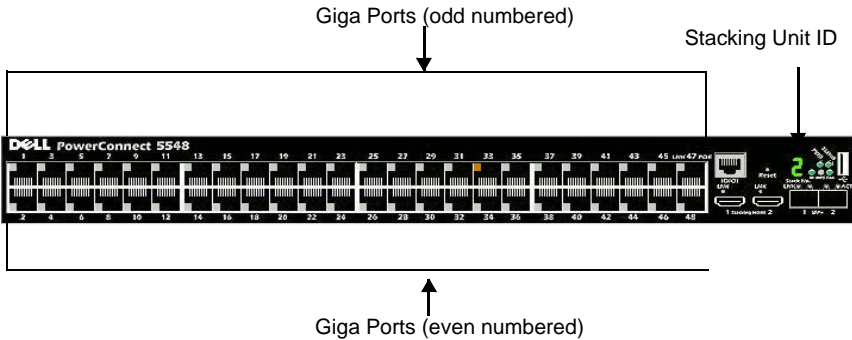

The graphic display on the home page displays the Unit ID and port indicators that specify whether a specific port is currently active. Table 9-1 describes the port colors that are displayed and their meaning:

Table 7-1. Port Colors

Component	Description
Amber	The port is currently connected at 100 Mbps.
Green	The port is currently connected at 1000 Mbps
Grey	The port is currently disconnected

NOTE: For more information about LEDs, see "LED Definitions" on page 38.

To configure a port double-click on its icon.

Only ports that are physically present are displayed in the PowerConnect OpenManage Switch Administrator home page, and can be configured through the web management system. Non-present ports can be configured through the CLI or SNMP interfaces.

Port Representation

Ports are referred to in the notation: [gi/te]x/0/z, where:

- gi—Giga port
- te —Ten Giga port
- x — Unit ID
- z — Port number

Using the Switch Administrator Buttons

This section describes the buttons found on the OpenManage Switch Administrator interface.

Information Buttons

Table 9-2 describes the information buttons that provide access to online support and online help, as well as information about the OpenManage Switch Administrator interfaces. These are displayed at the top of each page.

Table 7-2. Information Buttons

Button	Description
Support	Opens the Dell Support page at support.dell.com
About	Contains the version and build number and Dell copyright information.
Logout	Opens the Log Out window.

Device Management Icons

Table 9-3 describes the device management buttons.

Table 7-3. Device Management Icons





Button	Icon	Description
Apply&Save		Saves changes to the Running and Startup Configuration files.
Help		Open online help. The online help pages are context-sensitive. For example, if the IP Addressing page is open, the help topic for that page is displayed when Help is clicked.
Print		Prints the Network Management System page and/or table information.

Table 7-3. Device Management Icons (Continued)

Refresh		Refreshes device information from the Running Configuration file.
---------	---	---

Field Definitions

Fields that are user-defined can contain between 1–159 characters, unless otherwise noted on the OpenManage Switch Administrator web page. All letters or characters can be used, except the following: "\ / : * ? < > "

Common GUI Features

Table 9-4 describes the common functions that can be performed on many GUI pages.

Table 7-4. Common GUI Elements

Button	Description
Apply	Save changes entered in GUI page to the Running Configuration file.
Back	Go to previous page.
Cancel	Cancel changes entered in GUI page.
Clear All Counters	Delete counters.
Clear Counters	Delete selected counters.
Clear Log	Delete entries from log.
Clear Statistics	Delete statistics.
Copy parameters from	Copy the parameters from a selected row to the selected target rows.
Copy parameters from port	Copy the parameters from a selected port to the selected target ports.
Details	Shows further details relevant to the current page.
Next	Go to next page.
Query	Run a query after query criteria have been entered.
Remove	Remove checked elements in the page. If Select All is selected, all elements are removed.
Reset All Counters	Delete all counters.
Restore Defaults	Restores parameters entered in page to default values.

Table 7-4. Common GUI Elements (Continued)

Button	Description
Telnet	Opens a Telnet window. This only works in the Explorer 6 and Firefox browsers.

GUI Terms

Each GUI page in the tree view is described in the following sections. A brief introduction is provided along with steps specifying how to enter information in the page. The following terms are used:

- **Enter** — Indicates that information may be entered in the field. It does not imply that the field is mandatory.
- **Select** — Indicates that information may be selected from a drop-down list or from radio buttons.
- **Displays** — Indicates that the field is display only.

CLI Commands

There are certain command entry conventions that apply to all commands. The following table describes these conventions.

Table 7-5. Common GUI Elements

Button	Description
[]	In a command line, square brackets indicate an optional entry..
{ }	In a command line, curly brackets indicate a selection of compulsory parameters separated by the character. One option must be selected. For example: flowcontrol {auto on off} means that for the flowcontrol command either auto, on, or off must be selected.
<i>Italic Font</i>	Indicates a parameter value.
<i>Bold Italic Font</i>	Indicates a parameter key word.
<button-name>	Any individual key on the keyboard. For example click <Enter>.

Button	Description
Ctrl+F4	Any combination of keys clicked simultaneously, for example: Ctrl and F4.
Screen Display	Indicates system messages and prompts appearing on the console.
<i>all</i>	When a parameter is required to define a range of ports or parameters and all is an option, the default for the command is all when no parameters are defined. For example, the command interface range port-channel has the option of either entering a range of channels, or selecting all . When the command is entered without a parameter, it automatically defaults to all .

8

Network Security

This section describes the various mechanisms for providing security on the switch.

It contains the following topics:

- Port Security
- ACLs
- ACL Binding
- Proprietary Protocol Filtering
- Absolute Time Range
- Time Range Recurrence
- Dot1x Authentication

Port Security

Network security can be enhanced by limiting access on a port to users with specific MAC addresses. The MAC addresses can be dynamically learned, or they can be statically configured.

Port security has the following modes:

- **Classic Lock** — Locked port security monitors both received and learned packets that are received on specific ports. Access to the locked port is limited to users with specific MAC addresses. These addresses are either manually defined on the port, or learned on that port before it was locked.
- **Limited Dynamic Lock** — When a packet is received on a locked port, and the packet's source MAC address is not tied to that port (either it was learned on a different port, or it is unknown to the system), a protection mechanism, which provides various options is invoked. Unauthorized packets arriving to a locked port are either:
 - Forwarded
 - Discarded with no trap
 - Discarded with a trap
 - The port is shutdown

Locked port security enables storing a list of MAC addresses in the configuration file. The MAC addresses are restored when the device is reset.

Disabled ports can be activated from the **Port Configuration** page.

To configure port security:

- 1 Click **Switching > Network Security > Port Security** to display the **Port Security: Summary** page.

Figure 8-1. Port Security: Summary

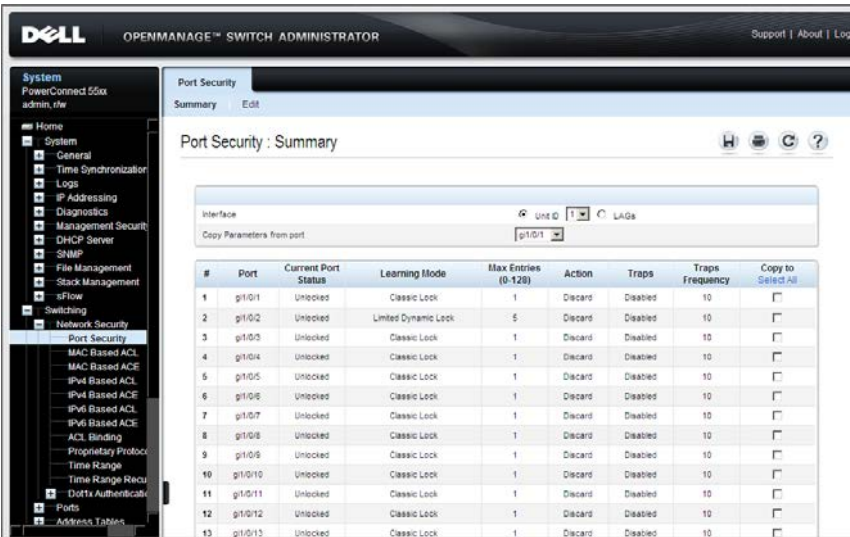

Security parameters are displayed for all ports or LAGs, depending on the selected interface type.

- 2 To modify the security parameters for a port, select it, and click **Edit**.
- 3 Enter the following fields:
 - **Interface** — Select the interface to be configured.
 - **Current Port Status** — Displays the current port status.
 - **Set Port** — Select to either lock or unlock the port.
 - **Learning Mode** — Set the locked port type. The **Learning Mode** field is enabled only if **Locked** is selected in the **Set Port** field. The possible options are:
 - **Classic Lock** — Locks the port using the classic lock mechanism. The port is immediately locked, regardless of the number of addresses that have already been learned.

- **Limited Dynamic Lock** — Locks the port by deleting the dynamic MAC addresses associated with the port. The port learns up to the maximum addresses allowed on the port. Both relearning and aging MAC addresses are enabled.
- **Max Entries (0-128)** — Enter the maximum number of MAC addresses that can be learned on the port. The **Max Entries** field is enabled only if **Locked** is selected in the **Set Port** field, and the **Limited Dynamic Lock** mode is selected in **Learning Mode** field.
- **Action on Violation** — Select the action to be applied to packets arriving on a locked port. The possible options are:
 - **Discard** — Discard the packets from any unlearned source.
 - **Forward** — Forward the packets from an unknown source, without learning the MAC address.
 - **Shutdown** — Discard the packet from any unlearned source, and shut down the port. Ports remain shutdown until they are reactivated, or the device is reset.
- **Trap** — Enable/disable traps being sent when a packet is received on a locked port.
- **Trap Frequency (1-1000000)** — Enter the amount of time (in seconds) between traps.

Configuring Port Security Using CLI Commands

The following table summarizes the CLI commands for configuring port security.

Table 8-1. Port Security CLI Commands

CLI Command	Description
<code>set interface active { [gigabitethernet tengigabitethernet] interface/port-channel LAG-number }</code>	Reactivates an interface that is shutdown due to port security reasons.

Table 8-1. Port Security CLI Commands (Continued)

CLI Command	Description
<code>port security max {max-addr}</code> <code>no port security max</code>	Specifies the maximum number of MAC addresses that can be learned on the port. Use the no form of this command to restore the default
<code>port security mode {lock max-addresses }</code> <code>no port security mode</code>	Configures the port security learning mode. Use the no form of this command to restore the default configuration.
<code>port security [forward discard discard-shutdown] [trap seconds]</code> <code>no port security</code>	Enables port security on an interface. Use the no form of this command to disable port security on an interface.
<code>port security [forward discard discard-shutdown] [trap seconds]</code> <code>no port security</code>	Configures port security on an interface. Use the no form of this command to disable port security.
<code>show ports security [[gigabitethernet tengigabitethernet] port-number] port-channel LAG-number]</code>	Displays lock status of specified interface or of all interfaces.

The following is an example of the CLI commands:

```
console # show ports security
```

Port	Status	Learning	Action	Maximum	Trap	Frequency
gil/0/1	Disabled	Max-Addresses	-	10	-	-
gil/0/2	Disabled	Lock	-	1	-	-
gil/0/3	Disabled	Lock	-	1	-	-
gil/0/4	Disabled	Lock	-	1	-	-
gil/0/5	Disabled	Lock	-	1	-	-
gil/0/6	Disabled	Lock	-	1	-	-
gil/0/7	Disabled	Lock	-	1	-	-
gil/0/8	Disabled	Lock	-	1	-	-
gil/0/9	Disabled	Lock	-	1	-	-
gil/0/10	Disabled	Lock	-	1	-	-
gil/0/11	Disabled	Lock	-	1	-	-
gil/0/12	Disabled	Lock	-	1	-	-

ACLs

This section describes Access Control Lists (ACLs), which enable defining classification actions and rules for specific ingress or egress ports.

It contains the following topics:

- ACL Overview
- MAC-Based ACLs
- MAC-Based ACEs
- IPv4-Based ACLs
- IPv4-Based ACEs
- IPv6-Based ACLs
- IPv6-Based ACEs

ACL Overview

Access Control Lists (ACLs) enable network managers to define classification actions and rules for specific ingress or egress ports. Packets entering an ingress or egress port, with an active ACL, are either admitted or denied entry. If entry is denied, the ingress or egress port may be disabled, for example, a network administrator defines an ACL rule that states that port number 20 can receive TCP packets, however, if a UDP packet is received, the packet is dropped.

ACLs are composed of Access Control Entries (ACEs) that are rules that determine traffic classifications. Each ACE is a single rule, and up to 256 rules may be defined on each ACL, and up to 3000 rules globally.

Rules are not only used for user configuration purposes, they are also used for features like DHCP Snooping, Protocol Group VLAN and iSCSI, so that not all 3000 rules are available for ACEs. It is expected that there will be at least 2000 rules available. If there are fewer rules available, this may be due to DHCP Snooping or iSCSI optimization. Reduce the number of entries in DHCP Snooping or reduce the max number of TCP connections in the iSCSI configuration in order to free rules for ACEs.

The following types of ACLs can be defined:

- **MAC-based ACL** — Examines Layer 2 fields only
- **IPv4-based ACL** — Examines the Layer 3 layer of IPv4 frames

- IPv6-based ACL —Examines the Layer 3 layer of IPv6 frames

MAC-Based ACLs

To define a MAC-based ACL:

- 1 Click **Switching > Network Security > MAC Based ACL** to display the **MAC Based ACL: Summary** page.

Figure 8-2. MAC Based ACL: Summary

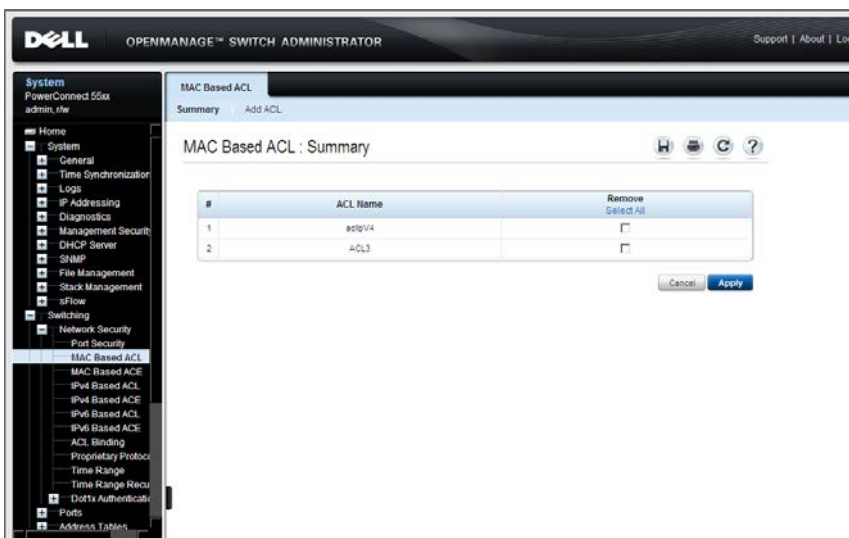

The currently-defined MAC-based ACLs are displayed.

- 2 To add a new ACL, click **Add ACL**, and enter the name of the new ACL.

Configuring MAC-Based ACLs Using CLI Commands

The following table summarizes the CLI commands for configuring MAC-based ACLs.

Table 8-2. MAC Based ACL CLI Commands

CLI Command	Description
<code>mac access-list extended acl-name</code>	Defines an ACL and places the device in MAC-extended ACL configuration mode.
<code>no mac access-list extended acl-name</code>	Use the no form of this command to remove the ACL.
<code>show interfaces access-lists</code>	Displays access lists applied on interfaces.

The following is an example of some of the CLI commands:

```
console# show access-lists
Extended IP access list ACL1
permit 234 172.30.40.1 0.0.0.0 any
permit 234 172.30.8.8 0.0.0.0 any
```

MAC-Based ACEs

To add rules to an ACL:

- 1 Click **Switching > Network Security > MAC Based ACE** to display the **MAC Based ACE: Summary** page.

Figure 8-3. MAC Based ACE: Summary

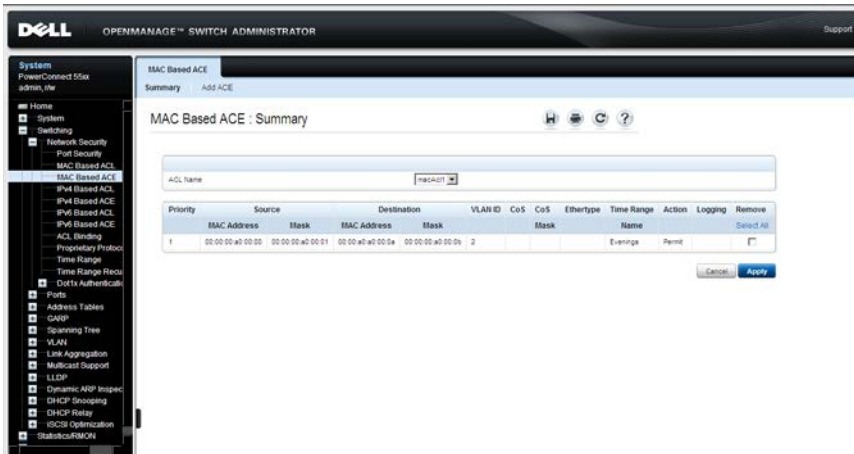

The currently-defined rules for the selected ACL are displayed.

- 2 To add a rule click **Add ACE**.
- 3 Select the ACL for which a rule is being created.
- 4 Enter the fields:
 - **New Rule Priority** — Enter the priority of the ACE. ACEs with higher priority are processed first. One is the highest priority
 - **Source MAC Address** — Match the source MAC address from which packets have arrived to this source address. In addition to the Source MAC address, you can enter a **Wildcard Mask** that specifies which bits in the source address are used for matching and which bits are ignored. A wildcard of 00:00:00:00:00:00 means the bits must be matched exactly; ff:ff:ff:ff:ff:ff means the bits are irrelevant. Any combination of 0s and ffs can be used.
 - **Any** — Check to indicate that the source address is not matched.

- **Dest. MAC Address** — Match the destination MAC address to which packets are addressed to this address. In addition to the Destination MAC address, you can enter a **Wildcard Mask** that specifies which bits in the source address are used for matching and which bits are ignored. A wildcard of 00:00:00:00:00:00 means the bits must be matched exactly; ff:ff:ff:ff:ff:ff means the bits are irrelevant. Any combination of 0s and ffs can be used.
- **Any** — Check to indicate that the destination address is not matched.
- **VLAN ID** — Match the packet's VLAN ID to this VLAN ID. The possible VLAN IDs are 1 to 4095.
- **CoS** — Match the packet's CoS value to this CoS value.
- **Cos Mask** — Match the packet's CoS value to one of these CoS values.
- **Ether type** — Match the packet's Ether type to this one.
- **Time Range Name** — Check to associate a time range with the ACE. Select one of the time ranges defined in the **Time Range** page.
- **Action** — Select the action taken upon a match. The following options are available:
 - **Permit** — Forward packets that meet the ACL criteria.
 - **Deny** — Drop packets that meet the ACL criteria.
 - **Shutdown** — Drop packets that meet the ACL criteria, and disable the port to which the packet was addressed.
- **Logging of Dropped Packets** — Check to activate logging of dropped packets.

Configuring MAC-Based ACEs Using CLI Commands

The following table summarizes the CLI commands for configuring MAC-based ACEs.

Table 8-3. MAC Based ACE CLI Commands

CLI Command	Description
permit { any <i>source-ip-address</i> <i>source-wildcard</i> } { any destination <i>destination-</i> <i>wildcard</i> } [eth-type <i>0</i> aarp amber dec- spanning dechnet- iv diagnostic dsm etype-6000] [vlan <i>vlan-id</i>] [cos <i>cos cos-</i> <i>wildcard</i>] [time-range <i>time-</i> <i>range-name</i>]	Sets permit conditions for an MAC access list (in MAC ACL configuration mode).
deny { any <i>source source-</i> <i>wildcard</i> } { any <i>destination</i> <i>destination-wildcard</i> } [eth-type <i>0</i> aarp amber dec- spanning dechnet-iv diagnostic dsm etype-6000] [vlan <i>vlan-id</i>] [cos <i>cos cos-wildcard</i>] [time- range <i>time-range-name</i>][disable- port log-input]	Sets deny conditions for an MAC access list.

The following is an example of some of the CLI commands:

```
console(config)# mac access-list extended server1
console(config-mac-acl)# permit 00:00:00:00:00:01
00:00:00:00:00:ff any
```

IPv4-Based ACLs

To define an IPv4-based ACL:

- 1 Click **Switching > Network Security > IPv4 Based ACL** to display the **IPv4 Based ACL: Summary** page.

Figure 8-4. IPv4 Based ACL: Summary

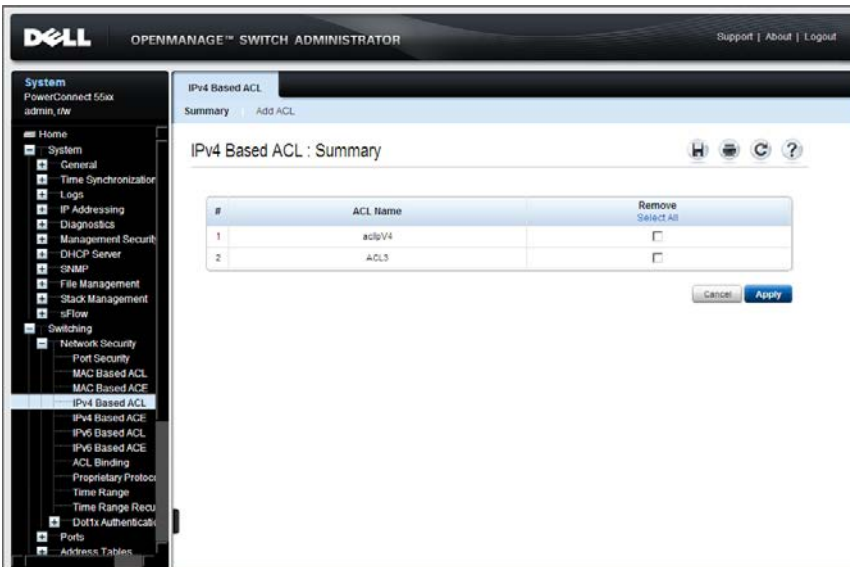

The previously-defined IPv4 ACLs are displayed.

- 2 To add a new ACL, click **Add ACL**.
- 3 Enter the name of the new ACL. Names are case-sensitive.

Configuring IP-based ACLs Using CLI Commands

The following table summarizes the CLI commands for configuring IP-based ACLs.

Table 8-4. IP-Based ACL CLI Commands

CLI Command	Description
<code>ip access-list extended acl-name</code>	Defines an IPv4 access list and places the device in IPv4 access list configuration mode
<code>no ip access-list extended acl-name</code>	Use the no form of this command to remove the access list.

The following is an example of some of the CLI commands:

```
console(config)# ip access-list extended server-acl
```

IPv4-Based ACEs

To add a rule to an ACL:

- 1 Click **Switching > Network Security > IPv4 Based ACE** to display the **IPv4 Based ACE** page.

Figure 8-5. IPv4 Based ACE: Summary

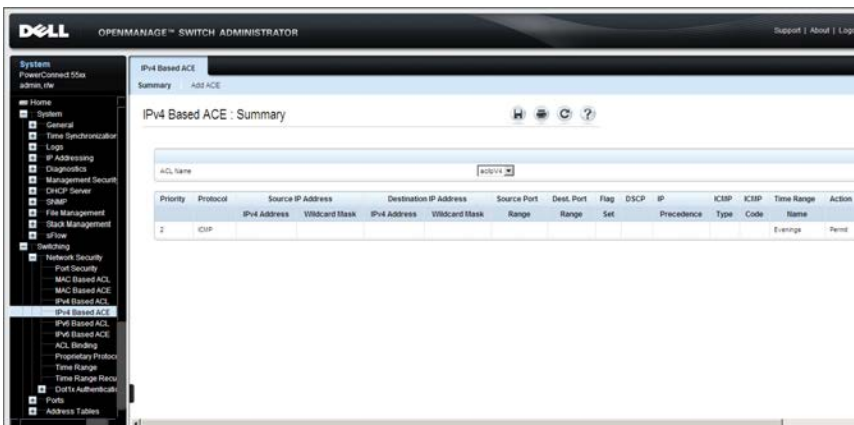

The currently-defined rules for the selected ACL are displayed.

- 2 To add a rule, click **Add ACE**.
- 3 Select a user-defined ACL, and enter the following fields:
 - **New ACE Priority (1-2147483647)** —Enter the priority of the ACE. ACEs with higher priority are processed first. One is the highest priority.
 - **Protocol Select From List** — Select to create an ACE, based on a specific protocol. The following options are available:
 - **ICMP** — Internet Control Message Protocol (ICMP). The ICMP enables the gateway or destination host to communicate with the source host, for example, to report a processing error.
 - **IGMP** — Internet Group Management Protocol (IGMP). Enables hosts to notify their local switch or router that they want to receive transmissions assigned to a specific multicast group.
 - **IPinIP** — IP in IP. Encapsulates IP packets to create tunnels between two routers. This ensures that IPIP tunnel appears as a single interface, rather than several separate interfaces. IPIP enables tunnel intranets occur the internet, and provides an alternative to source routing.
 - **TCP** — Transmission Control Protocol (TCP). Enables two hosts to communicate and exchange data streams. TCP guarantees packet delivery, and guarantees that packets are transmitted and received in the order they are sent.
 - **EGP** — Exterior Gateway Protocol (EGP). Permits exchanging routing information between two neighboring gateway hosts in an autonomous systems network.
 - **IGP** — Interior Gateway Protocol (IGP). Enables for routing information exchange between gateways in an autonomous network.
 - **UDP** — User Datagram Protocol (UDP). Communication protocol that transmits packets but does not guarantee their delivery.

- **HMP** — Host Mapping Protocol (HMP). Collects network information from various networks hosts. HMP monitors hosts spread over the internet as well as hosts in a single network.
 - **RDP** — Reliable Data Protocol (RDP). provide a reliable data transport service for packet-based applications.
 - **IDPR** — Matches the packet to the IDPR protocol.
 - **IDRP** — Matches the packet to the Inter-Domain Routing Protocol (IDRP).
 - **RVSP** — Matches the packet to the ReSerVation Protocol (RSVP).
 - **AH** — Authentication Header (AH). Provides source host authentication and data integrity.
 - **EIGRP** — Enhanced Interior Gateway Routing Protocol (EIGRP). Provides fast convergence, support for variable-length subnet mask, and supports multiple network layer protocols.
 - **OSPF** — The Open Shortest Path First (OSPF) protocol is a link-state, hierarchical interior gateway protocol (IGP) for network routing Layer Two (2) Tunneling Protocol, an extension to the PPP protocol that enables ISPs to operate Virtual Private Networks (VPNs).
 - **IPIP** — IP over IP (IPinIP). Encapsulates IP packets to create tunnels between two routers. This ensures that IPIP tunnel appears as a single interface, rather than several separate interfaces. IPIP enables tunnel intranets occur the internet, and provides an alternative to source routing.
 - **PIM** — Matches the packet to Protocol Independent Multicast (PIM).
 - **L2TP** — Matches the packet to Internet Protocol (L2IP).
 - **ISIS** — Intermediate System - Intermediate System (ISIS). Distributes IP routing information throughout a single autonomous system in IP networks.
- **Protocol ID To Match** — Enter a protocol number if you did not select a protocol by name.
 - **Any(IP)** — Check to use any protocol.

- **Source Port (0 - 65535)** — Enter the TCP/UDP source port. Enter either **Single**, **Range** or select **Any** to include all ports.
- **Destination Port (0 - 65535)** — Enter the TCP/UDP destination port. Enter either a **Single**, **Range** or select **Any** to include all ports.
- **Source IP Address** — Enter the source IP address to which addresses in the packet are compared.
 - **Wildcard Mask** — In addition to the **Source MAC address**, you can enter a mask that specifies which bits in the source address are used for matching and which bits are ignored. A wildcard of 0.0.0.0 means the bits must be matched exactly in addition to the IP source address; ff.ff.ff.ff means the bits are irrelevant. Any combination of 0s and ffs can be used.
 - **Any** — Check to indicate that the source address is not matched.
- **Dest. IP Address** — Enter the destination IP address to which addresses in the packet are compared.
 - **Wildcard Mask** — In addition to the **Destination MAC address**, you can enter a mask that specifies which bits in the source address are used for matching and which bits are ignored. A wildcard of 0.0.0.0 means the bits must be matched exactly in addition to the IP destination address; ff.ff.ff.ff means the bits are irrelevant. Any combination of 0s and ffs can be used.
 - **Any** — Check to indicate that the destination address is not matched.
- **TCP Flags** — To use TCP flags, check the **TCP Flag** checkbox and then check the desired flag(s).
- **ICMP** — Specifies an ICMP message type for filtering ICMP packets. This field is available only when ICMP is selected in the **Protocol** field. The following options are available:
 - **Select from List** — Select an ICMP type from the list.
 - **ICMP Type** — Enter the ICMP type.
 - **Any** — Check to use all ICMP types.

- **ICMP Code** — Enter an ICMP message code for filtering ICMP packets that are filtered by ICMP message type or ICMP message code. This field is available only when ICMP is selected in the **Protocol** field. The following options are available:
 - **ICMP Code** — Enter an ICMP code.
 - **Any** — Check to use all ICMP codes.
- **IGMP** — IGMP packets can be filtered by IGMP message type. This field is available only when IGMP is selected in the **Protocol** field. The following options are available:
 - **Select from List** — Select an IGMP message type from the list.
 - **IGMP Type** — Enter the IGMP message type.
 - **Any** — Check to use all IGMP message types.
- **Classification** — Select one of the following matching options:
 - **Match DSCP(0-63)** — Matches the packet DSCP value to the ACL.
 - **Match IP Precedence(0-7)** — Check to enable matching IP-precedence with the packet IP-precedence value. IP-precedence enables marking frames that exceed the CIR threshold. In a congested network, frames containing a higher DP value are discarded before frames with a lower DP value. If this field is checked, enter a value to be matched.
- **Time Range Name** — Check to associate a time range with the ACE. Select one of the time ranges defined in the **Time Range** page.
- **Action** — Select the ACL forwarding action. The following options are available:
 - **Permit** — Forward packets which meet the ACL criteria.
 - **Deny** — Drop packets which meet the ACL criteria.
 - **Shutdown** — Drop packet that meet the ACL criteria, and disable the port to which the packet was addressed.
- **Logging of Dropped Packets** — Check to activate logging of dropped packets.

Configuring IP-based ACEs Using CLI Commands

The following table summarizes the CLI commands for configuring IP-based ACLs.

Table 8-5. IP-Based ACE CLI Commands

CLI Command	Description
<code>permit protocol {any source-ip-address source-wildcard} {any destination-ip-address destination-wildcard} [dscp number precedence number] [time-range time-range-name]</code>	Sets conditions to allow a packet to pass a named IP access list (in access list configuration mode).
<code>permit icmp {any source-ip-address source-wildcard} {any destination-ip-address destination-wildcard} [any icmp-type][any icmp-code] [dscp number precedence number] [time-range time-range-name]</code>	The list of protocols is found above.
<code>permit igmp {any source-ip-address source-wildcard} {any destination-ip-address destination-wildcard}[igmp-type] [dscp number precedence number] [time-range time-range-name]</code>	
<code>permit tcp {any source-ip-address source-wildcard} {any source-port/port-range}{any destination-ip-address destination-wildcard} {any destination-port/port-range} [dscp number precedence number] [match-all list-of-flags] [time-range time-range-name]</code>	
<code>permit udp {any source-ip-address source-wildcard} {any source-port port-range} {any destination-ip-address destination-wildcard} {any destination-port port-range} [dscp number precedence number] [match-all time-range-name] [time-range time-range-name]</code>	

Table 8-5. IP-Based ACE CLI Commands (Continued)

CLI Command	Description
deny protocol { any <i>source-ip-address source-wildcard</i> } { any <i>destination-ip-address destination-wildcard</i> } [dscp <i>number</i> precedence <i>number</i>] [time-range <i>time-range-name</i>] [disable-port log-input]	Sets deny conditions for IPv4 access list (in access list configuration mode).
deny icmp { any <i>source-ip-address source-wildcard</i> } { any <i>destination-ip-address destination-wildcard</i> }{ any <i>icmp-type</i> } { any <i>icmp-code</i> } [dscp <i>number</i> precedence <i>number</i>] [time-range <i>time-range-name</i>] [disable-port log-input]	
deny igmp { any <i>source-ip-address source-wildcard</i> } { any <i>destination-ip-address destination-wildcard</i> }[<i>igmp-type</i>] [dscp <i>number</i> precedence <i>number</i>] [time-range <i>time-range-name</i>] [disable-port log-input]	
deny tcp { any <i>source-ip-address source-wildcard</i> } { any <i>source-port</i> <i>port-range</i> }{ any <i>destination-ip-address destination-wildcard</i> } { any <i>destination-port</i> <i>port-range</i> } [dscp <i>number</i> precedence <i>number</i>] [<i>match-all list-of-flags</i>] [time-range <i>time-range-name</i>] [disable-port log-input]	
deny udp { any <i>source-ip-address source-wildcard</i> } { any <i>source-port</i> <i>port-range</i> } { any <i>destination-ip-address destination-wildcard</i> } { any <i>destination-port</i> <i>port-range</i> } [dscp <i>number</i> precedence <i>number</i>] [<i>match-all time-range-name</i>] [time-range <i>time-range-name</i>] [disable-port log-input]	

The following is an example of some of the CLI commands:

```
console(config)# ip access-list extended server
console(config-ip-al)# permit ip 1.1.1.0 0.0.0.255
1.1.2.0 0.0.0.0
```

IPv6-Based ACLs

The IPv6 Based ACL Page displays and enables the creation of IPv6 ACLs, which check pure IPv6-based traffic. IPv6 ACLs do not check IPv6-over-IPv4 or ARP packets.

To define IPv6-based ACLs:

- 1 Click **Switching > Network Security > IPv6 Based ACL** to display the **IPv6 Based ACL: Summary** page.

Figure 8-6. IPv6 Based ACL: Summary

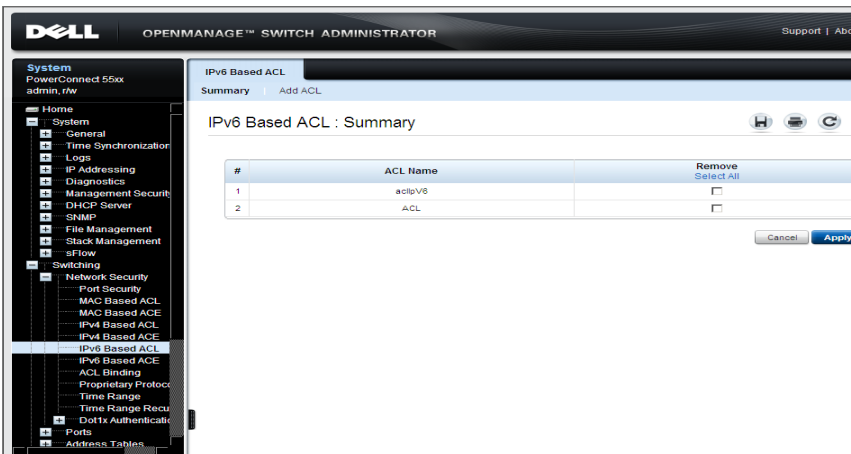

A list of all of the currently defined IPv6-based ACLs is displayed.

- 2 To add a new ACL, click **Add ACL**.
- 3 Enter the name of the new ACL. Names are case-sensitive.

Configuring IPv6-based ACLs Using CLI Commands

The following table summarizes the CLI commands for configuring IPv6-based ACLs.

Table 8-6. IP-Based ACL CLI Commands

CLI Command	Description
<code>ipv6 access-list [access-list-name]</code>	Defines an IPv6 access list and places the device in IPv6 access list configuration mode
<code>no ipv6 access-list [access-list-name]</code>	Use the no form of this command to remove the access list.

The following is an example of some of the CLI commands:

```
console(config)# ipv6 access-list server-acl
```

IPv6-Based ACEs

To add a rule to an IPv6-based ACL:

- 1 Click Switching > Network Security > IPv6 Based ACE to display the IPv6 ACE: Summary page.

Figure 8-7. IPv6 Based ACE: Summary

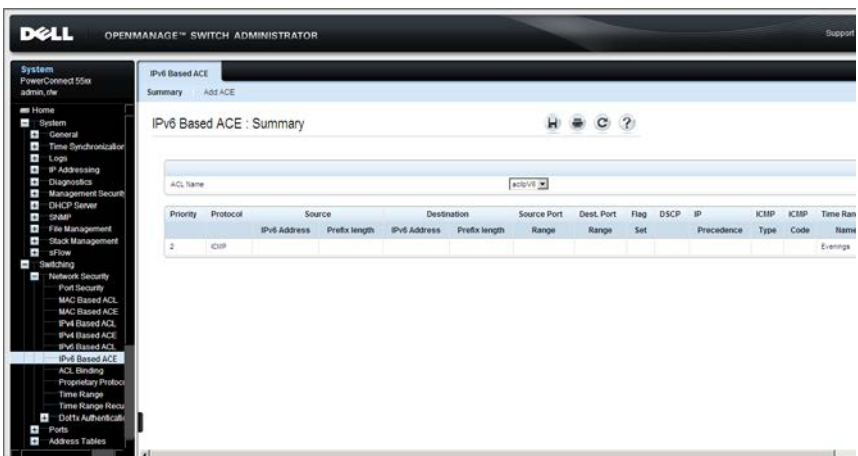

The currently-defined rules for the selected ACL are displayed.

- 2 To add a rule click **Add ACE**.
- 3 Select a user-defined ACL for which a rule is being created.
- 4 Enter the following fields:
 - **New Rule Priority** — Enter the ACE priority that determines which ACE is matched to a packet, based on a first match.
 - **Protocol Select from List** — Select to create an ACE, based on a specific protocol. The following options are available:
 - **TCP** — Transmission Control Protocol (TCP). Enables two hosts to communicate and exchange data streams. TCP guarantees packet delivery, and guarantees packets are transmitted and received in the order they are sent.
 - **UDP** — User Datagram Protocol (UDP). Communication protocol that transmits packets but does not guarantee their delivery.
 - **ICMP** — Internet Control Message Protocol (ICMP). The ICMP allows the gateway or destination host to communicate with the source host. For example, to report a processing error.
 - **IPV6** — Matches the packet to the IPV6 protocol.
 - **Protocol ID To Match** — Enter a protocol.
 - **Any** — Check to use any protocol.
 - **Source Port** — Enter the TCP/UDP source port. Enter either a **Single**, **Range** or select **Any** to include all ports.
 - **Destination Port** — Enter the TCP/UDP destination port. Enter either a **Single**, **Range** or select **Any** to include all ports.
 - **TCP Flags** — To use TCP flags, check the **TCP Flag** checkbox and then check the desired flag(s).
 - **ICMP** — Specifies an ICMP message type for filtering ICMP packets. This field is available only when ICMP is selected in the **Protocol** field. The following options are available:
 - **Select from List** — Select an ICMP type from the list.
 - **ICMP Type** — Enter the ICMP type.

- **Any** — Check to use all ICMP types.
- **ICMP Code** — Specifies an ICMP message code for filtering ICMP packets that are filtered by ICMP message type or ICMP message code. This field is available only when ICMP is selected in the **Protocol** field. The following options are available:
 - **ICMP Code** — Enter an ICMP code.
 - **Any** — Check to use all ICMP codes.
- **Source IP Address** — Enter the source IP address to which addresses in the packet are compared. The following options are available:
 - **Prefix Length** —The number of bits that comprise the source IP address prefix of the subnetwork.
 - **Any** — Check to indicate that the source address is not matched.
- **Dest. IP Address** — Enter the destination IP address to which addresses in the packet are compared. The following options are available:
 - **Prefix Length** —The number of bits that comprise the destination IP address prefix of the subnetwork.
 - **Any** — Check to indicate that the destination address is not matched.
- **Traffic Class** — Select one of the following options:
 - **Match DSCP** — Matches the packet DSCP value to the ACL.
 - **Match IP Precedence** — Matches the IP-precedence with the packet IP-precedence value. IP-precedence enables marking frames that exceed CIR threshold. In a congested network, frames containing a higher DP value are discarded before frames with a lower DP value.
- **Time Range Name** — Check to associate a time range with the ACE. Select one of the time ranges defined in the **Time Range** page.
- **Action** — The ACL forwarding action. The following options are available:
 - **Permit** — Forwards packets that meet the ACL criteria.
 - **Deny** — Drops packets that meet the ACL criteria.

- **Shutdown** — Drops packet that meet the ACL criteria, and disables the port to which the packet was addressed.
- **Logging of Dropped Packets** — Check to activate logging of dropped packets.

Configuring IP-based ACEs Using CLI Commands

The following table summarizes the CLI commands for configuring IP-based ACLs.

Table 8-7. IP-Based ACE CLI Commands

CLI Command	Description
<code>permit protocol {any {source-prefix/length } {any destination-prefix/length } [dscp number precedence number] [time-range time-range-name]</code>	Sets permit conditions for IPv6 access list.
<code>permit icmp {any {source-prefix/length } {any destination-prefix/length } {any icmp-type} {any icmp-code} [dscp number precedence number] [time-range time-range-name]</code>	
<code>permit tcp {any {source-prefix/length } {any source-port/port-range} {any destination-prefix/length } {any destination-port/port-range} [dscp number precedence number] [match-all list-of-flags] [time-range time-range-name]</code>	
<code>permit udp {any {source-prefix/length } {any source-port/port-range} {any destination-prefix/length } {any destination-port/port-range} [dscp number precedence number] [time-range time-range-name]</code>	

Table 8-7. IP-Based ACE CLI Commands (Continued)

CLI Command	Description
deny protocol { any { <i>source-prefix/length</i> } { any <i>destination-prefix/length</i> } [<i>dscp number</i> <i>precedence number</i>] [time-range <i>time-range-name</i>] [disable-port log-input]	Sets deny conditions for IPv4 access list (in Access List Configuration mode).
deny icmp { any { <i>source-prefix/length</i> } { any <i>destination-prefix/length</i> } { any <i>icmp-type</i> } { any <i>icmp-code</i> } [<i>dscp number</i> <i>precedence number</i>] [time-range <i>time-range-name</i>] [disable-port log-input]	
deny tcp { any { <i>source-prefix/length</i> } { any <i>source-port/port-range</i> } } { any <i>destination-prefix/length</i> } { any <i>destination-port/port-range</i> } [<i>dscp number</i> precedence number] [match-all list-of-flags] [time-range <i>time-range-name</i>] [disable-port log-input]	
deny udp { any { <i>source-prefix/length</i> } } { any <i>source-port/port-range</i> } } { any <i>destination-prefix/length</i> } { any <i>destination-port/port-range</i> } [<i>dscp number</i> precedence number] [time-range <i>time-range-name</i>] [disable-port log-input]	

The following is an example of some of the CLI commands:

```
console(config)# ipv6 access-list server
console(config-ipv6-al)# permit tcp 3001::2/64 any any 80
```

ACL Binding

When an ACL is bound to an interface, all the rules that have been defined for the ACL are applied to that interface. Whenever an ACL is assigned on a port or LAG, flows from that ingress or egress interface that do not match the ACL, are matched to the default rule, which is to **Drop unmatched packets**. To change the default action for unmatched packets to an action other than Drop, do the following:

- Add an additional ACE to the ACL with "Any" in all fields
- Set its action other than Drop
- Set the priority to the lowest in the ACL.

To bind ACLs to interfaces:

- 1 Click **Switching > Network Security > ACL Binding** to display the **ACL Binding: Summary** page.

Figure 8-8. ACL Binding: Summary

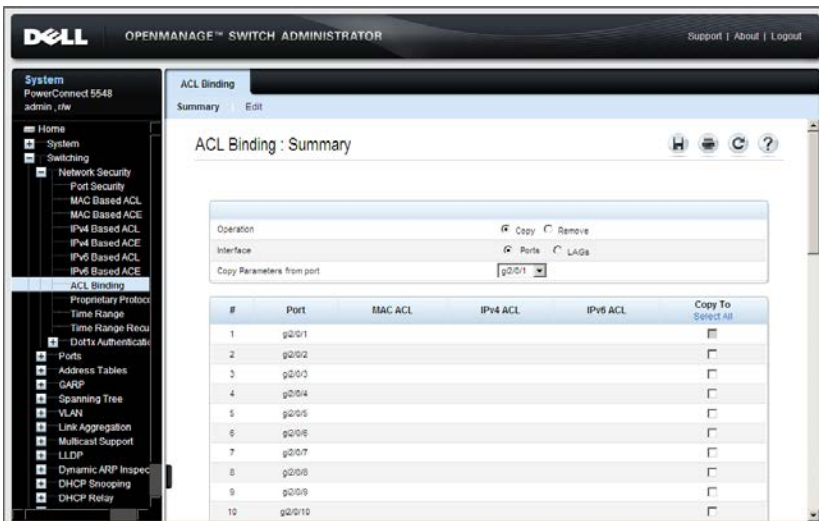

The ports on the selected unit are displayed along with their associated ACLs.

- 2 To bind an ACL to an interface, select an interface and click Edit.
- 3 Select an ACL(s). You can select one of each type (MAC-based ACL, IPv4-based ACL or IPv6-based ACL) or one IPv4-based ACL and one IPv6-based ACL.

Configuring ACL Bindings Using CLI Commands

The following table summarizes the CLI commands for configuring ACL Bindings.

Table 8-8. ACL Bindings CLI Commands

CLI Command	Description
service-acl input <i>acl-name1</i> [<i>acl-name2</i>]	Controls access to an interface
no service-acl input	Use the no form of the command to remove access control.
show access-lists [<i>acl-name</i>]	Displays access control lists (ACLs) configured on the switch.

The following is an example of some of the CLI commands:

```
console(config)# mac access-list extended server
console(config-mac-acl)# permit 00:00:00:00:00:01
00:00:00:00:00:ff any
console(config-mac-acl)# exit
console(config)# interface gi1/0/1
console(config-if)# service-acl input server
```

Proprietary Protocol Filtering

Protocol filters are used to disallow receiving specific proprietary protocol packets through an interface. These can be enabled for specific ports.

If a protocol filter is enabled on a port, you cannot enable a QoS ACL on this port.

To configure Proprietary Protocol Filtering:

- 1 Click **Switching > Network Security > Proprietary Protocol Filtering** to display the **Proprietary Protocol Filtering: Summary** page.

Figure 8-9. Proprietary Protocol Filtering: Summary

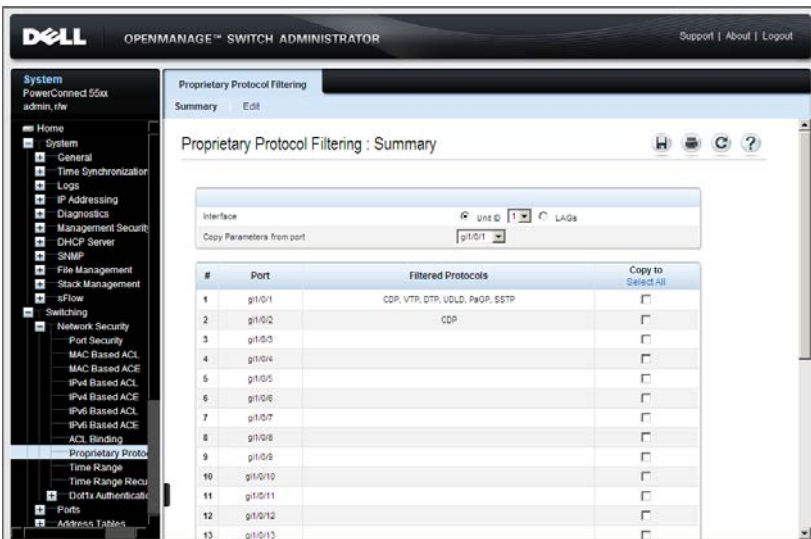

A list of the ports and their filtered protocols is displayed.

- 2 Click **Edit** to modify the filtered protocols for a specific port.
- 3 Select a unit and an interface.

- 4 Move the required protocols from the **Available Protocols** list to the **Filtered Protocols** list. The following displays the protocols and the addresses that are blocked:

Table 8-9. Protocol Filtering

Protocol	Destination Address	Protocol Type
blockcdp	0100.0ccc.cccc	0x2000
blockvtp	0100.0ccc.cccc	0x2003
blockdtp	0100.0ccc.cccc	0x2004
blocklld	0100.0ccc.cccc	0x0111
blockpagp	0100.0ccc.cccc	0x0104
blocksstp	0100.0ccc.cccd	-
blockall	0100.0ccc.ccc0 - 0100.0ccc.cccf	-

Configuring Proprietary Protocol Filtering Using CLI Commands

The following table summarizes the CLI commands for setting fields in the **Proprietary Protocol Filtering** pages.

Only one of the following CLI commands can be active on a port at the same time. To add other protocol filters, the command must be negated and then run again with all the required protocol names.

Table 8-10. Proprietary Protocol Filtering CLI Commands

CLI Command	Description
service-acl input <i>protocol1</i> [<i>protocol2 ... protocol6</i>]	Discards packets that are classified to specific protocols.
no service-acl input	Use the no form of those commands to disable discarding of the packets.

The following is an example of some of the CLI commands:

```
console (Config-if)# service-acl input blockcdp blockvtp
```

Time Range

Time ranges can be defined and associated with an QoS ACL, so that it is applied only during that time range.

There are two types of time ranges:

- **Absolute** — This type of time range begins on a specific date or immediately and ends on a specific date or extends infinitely. It is created in the **Time Range** pages. A recurring element can be added to it.
- **Recurring** — This is a time range element that is added to an absolute range, and begins and ends on a recurring basis. It is defined in the **Time Range Recurrence** pages.

If a time range includes both absolute and recurring ranges, the ACL is activated only if both absolute start time and the recurring time range have been reached. The ACL is deactivated when either of the time ranges is reached.

The switch supports a maximum of 10 absolute time ranges.

All time specifications are interpreted as local time (Daylight Savings Time does not affect this).

To ensure that the time range entries take effect at the desired times, the system time must be set. For more information on setting the system time, see "Time Synchronization" on page 162.

A possible use for this feature is to limit access of computers to the network only during business hours, after which they are locked, and access to the rest of the network is blocked.

Absolute Time Range

To define an absolute time range:

- 1 Click **Switching > Network Security > Time Range** to display the **Time Range: Summary** page.

Figure 8-10. Time Range: Summary

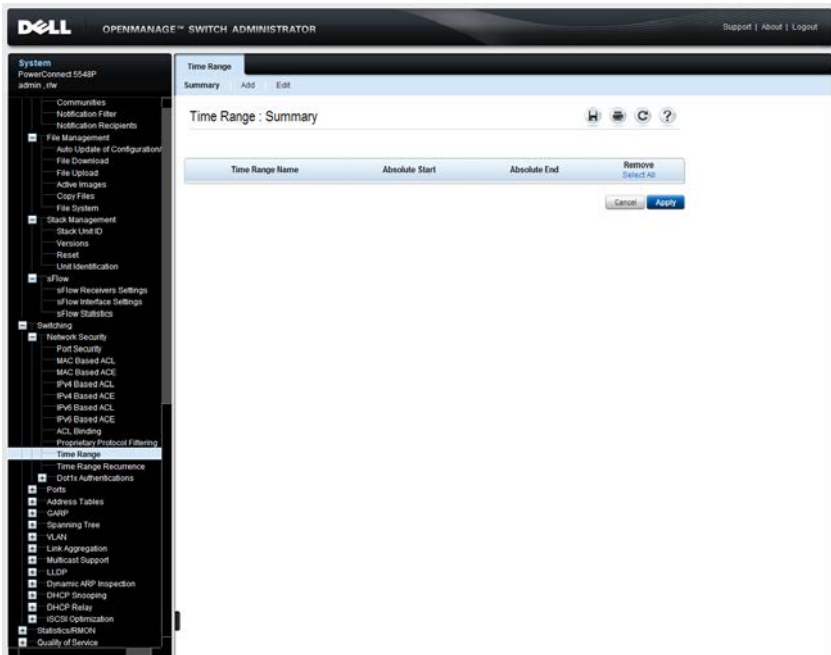

The existing Time Ranges are displayed.

- 2 To add a new time range, click **Add**.
- 3 Enter the name of the time range in the **Time Range Name** field.
- 4 Define the **Absolute Start** time.
 - To begin the Time Range immediately, click **Immediate**.
 - To determine at what time in the future the Time Range will begin, enter values in the **Date** and **Time** fields.

5 Define the **Absolute End** time.

- To indicate that the Time Range should not end, click **Infinite**.
- To determine the time at which the Time Range ends, enter values in the **Date** and **Time** fields.

See "Configuring Time Ranges Using CLI Commands" on page 125 for the CLI commands for creating time ranges.

Time Range Recurrence

To add a recurring time range element to an absolute time range:

- 1** Click **Switching > Network Security > Time Range Recurrence** to display the **Recurring Time Range: Summary** page.

Figure 8-11. Recurring Time Range: Summary

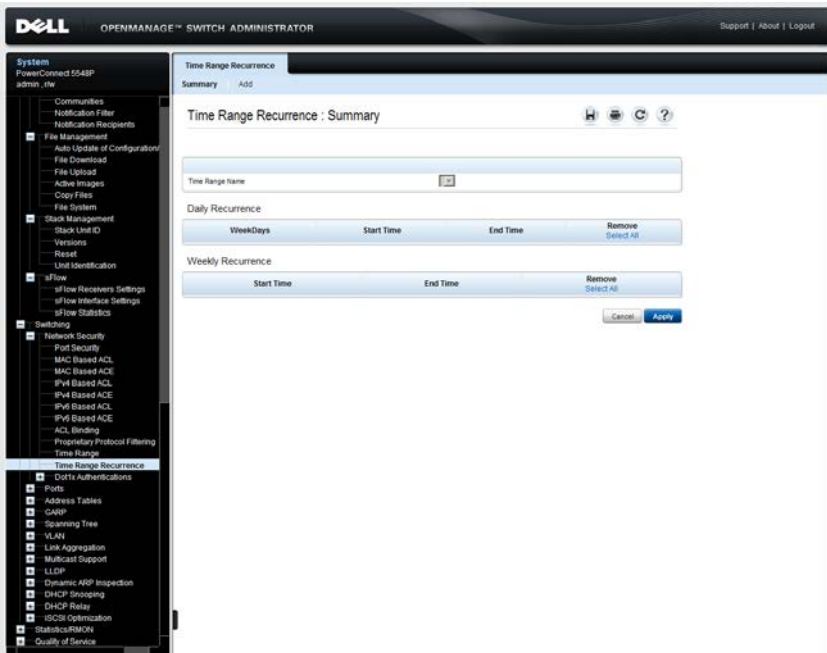

A daily and weekly recurring element of the time range that is selected is displayed if they exist.

- 2 To add a recurring time range element to a time range, click **Add**.
- 3 Select the **Time Range Name** to which you want to add the Time Range Recurrence. The **Absolute Start** and **Absolute End** fields are displayed.
- 4 Check if the recurrence is **Daily** or **Weekly** in **Recurrence type**.
- 5 If the recurrence is **Daily**, enter:
 - **Start Time** — Select the time on which the time range starts.
 - **End Time**— Select the time on which the time range ends.
 - **Weekday** — Select the day of the week on which the time range occurs.
- 6 If the recurrence is **Weekly**, enter:
 - **Start** — Select the **Day of the Week** and **Time** on which the time range starts.
 - **End** —Select the **Day of the Week** and **Time** on which the time range ends.

Configuring Time Ranges Using CLI Commands

The following table summarizes the CLI commands for configuring time ranges.

Table 8-11. Time Range CLI Commands

CLI Command	Description
<code>time-range time-range-name</code>	Enables time-range configuration mode, and defines time ranges for functions (such as access lists).
<code>no time-range time-range-name</code>	Use the no form of this command to remove the time range configuration.
<code>absolute start hh:mm day month year</code>	Adds start and end times to the time range.
<code>no absolute start</code>	Use the no form of the commands to remove the start and end times from the time range.
<code>absolute end hh:mm day month year</code>	
<code>no absolute end</code>	

Table 8-11. Time Range CLI Commands (Continued)

CLI Command	Description
periodic <i>day-of-the-week hh:mm to day-of-the-week hh:mm</i>	Adds a recurring time range to the time range.
no periodic <i>day-of-the-week hh:mm to day-of-the-week hh:mm</i> periodic list <i>hh:mm to hh:mm day-of-the-week1 [day-of-the-week2... day-of-the-week7]</i>	Use the no form of the commands to remove the recurring time range.
no periodic list <i>hh:mm to hh:mm day-of-the-week1 [day-of-the-week2... day-of-the-week7]</i>	
periodic list <i>hh:mm to hh:mm all</i>	
no periodic list all <i>hh:mm to hh:mm all</i>	

The following is an example of some of the CLI commands:

```
console (config)# time-range http-allowed
console (config-time-range)# absolute start 12:00 1 jan
2005 end 12:00 31 dec 2005
console (config-time-range)# periodic monday 8:00 to
friday 20:00
```

Dot1x Authentication

This section describes Dot1x authentication.

It contains the following topics:

- Port-Based Authentication Overview
- Dot1x Overview
- Port-Based Authentication Global
- Port-Based Authentication Interface Settings
- Monitoring Users
- Host Authentication
- Port Authentication Users

Port-Based Authentication Overview

Port-based authentication enables authenticating system users on a per-port basis via an external server. Only authenticated and approved system users can transmit and receive data. Ports are authenticated via the RADIUS server using the Extensible Authentication Protocol (EAP). Port Authentication includes:

- **Authenticators** — Specifies the device port that is authenticated before permitting system access.
- **Supplicants** — Specifies the host connected to the authenticated port that is requesting to access the system services.
- **Authentication Server** — Specifies the external server, for example, a RADIUS server, which performs authentication on behalf of the authenticator, and indicates whether the supplicant is authorized to access system services.

Port-based authentication creates two access states:

- **Controlled Access** — Permits communication between the supplicant and the system, if the supplicant is authorized.
- **Uncontrolled Access** — Permits uncontrolled communication, regardless of the port authorization state.

The device supports Port Based Authentication via RADIUS servers.

Dot1x Overview

Dot1x is an IEEE standard for port-based network access control. The Dot1x framework enables a device (the supplicant) to request port access from a remote device (authenticator) to which it is connected. The supplicant is permitted to send data to the port only after it is authenticated and authorized. If it is not authenticated and authorized, the authenticator discards the supplicant data, unless the data is sent to a Guest VLAN and/or non-authenticated VLANs.

Authentication of the supplicant is performed by an external RADIUS server through the authenticator. The authenticator monitors the results of the authentication.

In the Dot1x standard, a device can be a supplicant and an authenticator at a port, simultaneously requesting and granting port access. However, this device can only act as an authenticator, and does not take on the role of a supplicant.

The following varieties of Dot1x exist:

- **Single session Dot1x:**
 - **A1—Single-session/Single Host** — In this mode, the switch, as an authenticator, supports a single Dot1x session, and grants permission to use the port to an authorized supplicant. All other access requests, made by other devices received from the same port, are denied until the authorized supplicant is no longer using the port, or the access request is to an unauthenticated or guest VLAN.
 - **Single-session/Multiple Hosts**—This follows the Dot1x standard. In this mode, the switch, as an authenticator, enables any device to use a port, as long as it has been granted permission as a supplicant at the port.
- **Multi-Session Dot1x**—Every device (supplicant) connecting to a port must be authenticated and authorized by the switch (authenticator), separately in a different Dot1x session. This is the only mode that supports Dynamic VLAN Assignment (DVA).

Dynamic VLAN Assignment (DVA)

Dynamic VLAN Assignment (DVA) is also referred to as RADIUS VLAN Assignment in this guide. When a port is in Multiple Session mode and is DVA-enabled, the switch automatically adds the port as an untagged member of the VLAN that is assigned by the RADIUS server during the authentication process. The switch classifies untagged packets to the assigned VLAN if the packets originated from the devices or ports that are authenticated and authorized.

For a device to be authenticated and authorized at a DVA-enabled port:

- The RADIUS server must authenticate the device and dynamically assign a VLAN to the device.
- The assigned VLAN must not be the default VLAN and must have been created on the switch.
- The switch must not be configured to use both a DVA and a MAC-based VLAN group.
- A RADIUS server must support DVA with RADIUS attributes tunnel-type (64) = VLAN (13), tunnel-media-type (65) = 802 (6), and tunnel-private-group-id = a VLAN ID.

Dynamic Policy/ACL Assignment

The Dynamic Policy/ACL Assignment feature enables specifying a user-defined ACL or policy in the RADIUS server. After a successful authentication, the user is assigned that ACL.

Authentication Methods

The possible authentication methods are:

- **Dot1x** — The switch supports this authentication mechanism, as described in the standard, to authenticate and authorize Dot1x supplicants.
- **MAC-based** — The switch can be configured to use this method to authenticate and authorize devices that do not support Dot1x. The switch emulates the supplicant role on behalf of the non-Dot1x-capable devices, and uses the MAC address of the devices as the username and password, when communicating with the RADIUS servers. MAC addresses for

username and password must be entered in lower case and with no delimiting characters (for example: aaccbb55ccff). To use MAC-based authentication at a port:

- A Guest VLAN must be defined.
- The port must be Guest-VLAN-enabled.
- The packets from the first supplicant, at the port before it is authorized, must be untagged.

You can configure a port to use Dot1x only, MAC-based only, or Dot1x and MAC-based authentication. If a port is configured to use both Dot1x and MAC-based authentication, a Dot1x supplicant has precedence over a non-Dot1x device. The Dot1x supplicant preempts an authorized, but non-Dot1x device, at a port that is configured with a single session.

Unauthenticated VLAN and Guest VLANs

Unauthenticated VLANs and Guest VLANs provide access to services that do not require the subscribing devices or ports to be Dot1x or MAC-Based authenticated and authorized.

An unauthenticated VLAN is a VLAN that allows access by authorized and unauthorized devices or ports. You can configure one or more VLAN to be unauthenticated in the **VLAN Membership** pages in "VLANs" on page 459.

An unauthenticated VLAN has the following characteristics:

- It must be a static VLAN, and cannot be the Guest VLAN or the default VLAN.
- The VLAN's member ports must be manually configured as tagged members.
- The member ports must be trunk and/or general ports. An access port cannot be member of an unauthenticated VLAN.

The Guest VLAN, if configured, is a static VLAN with the following characteristics.

- It must be manually defined from an existing, static VLAN.
- It is automatically available only to unauthorized devices, or to ports of devices that are connected and Guest VLAN enabled.

- If a port is Guest-VLAN-enabled, the switch automatically adds the port as an untagged member of the Guest VLAN when the port is not authorized, and removes the port from the Guest VLAN when the first supplicant of the port is authorized.
- The Guest VLAN cannot be used as both the Voice VLAN and an unauthenticated VLAN.

The switch also uses the Guest VLAN for authentication at ports configured with Multiple Session mode and MAC-based authentication. Therefore, you must configure a Guest VLAN before you can use the MAC-based authentication mode.

For authentication to function, it must be activated both globally, in the **Port-Based Authentication Global** page and individually on each port, in the **Port-Based Authentication Interface Settings** pages.

Monitoring Mode

Monitoring mode enables providing users who fail authentication with limited network access. This enables these users to correct the reason that the authentication failed.

The following are the main aspects of this feature:

- Enables successful authentications using the returned RADIUS information
- Provides a mechanism to report unsuccessful authentications without negative repercussions to the user due to administrator errors
- Accurately reports the data received from the successful and non-successful operations so that appropriate changes to problem areas may be made.

The Dot1x monitoring activation command includes a special VLAN that is used when there is no access interface configuration present and the client(s) unsuccessfully authenticates. These clients are placed in the special VLAN. For users that unsuccessfully authenticate during re-authentication process, but already have existing VLANs configured, the failure to authenticate does not put them in a disabled state but places them back to the existing configuration.

Port-Based Authentication Global

To globally configure authentication:

- 1 Click **Switching > Network Security > Dot1 Authentication > Port Based Authentication Global** to display the **Port Based Authentication Global** page.

Figure 8-12. Port Based Authentication Global

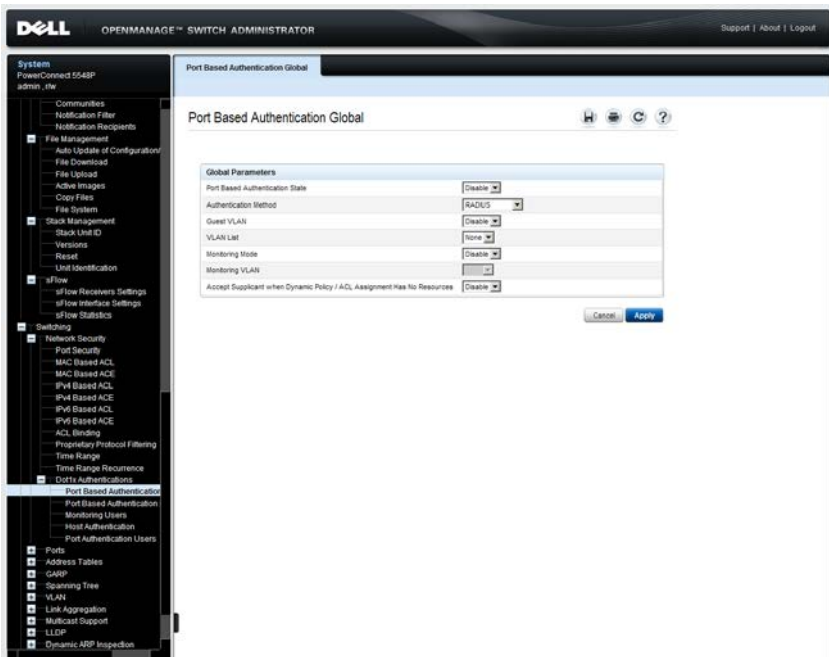

- 2 Enter the following fields:
 - **Port Based Authentication State** — Enable/disable port-based authentication.
 - **Authentication Method** — Select an authentication method. The possible options are:

- **RADIUS, None** — Perform port authentication first by using the RADIUS server. If no response is received from RADIUS (for example, if the server is down), then no authentication is performed, and the session is permitted.
 - **RADIUS** — Authenticate the user on the RADIUS server. If no authentication is performed, the session is not permitted.
 - **None** — Do not authenticate the user. Permit the session.
- **Guest VLAN** — Enable/disable the use of a Guest VLAN for unauthorized ports. If a Guest VLAN is enabled, all unauthorized ports automatically join the VLAN selected in the Guest VLAN ID field. If a port is later authorized, it is removed from the Guest VLAN.
 - **VLAN List** — Select the Guest VLAN from the VLAN list.
 - **Monitoring Mode** — Enable/disable logging authentication attempts.
 - **Monitoring VLAN** — Enter the ID of the VLAN to which traffic being monitored is routed after unsuccessful Dot1x authentication.
 - **Accept Supplicant when Dynamic Policy/ACL Assignment Has No Resources** — If no resources remain in the TCAM, the system can either reject (disable) or allow (enable) successful authentication.

Enabling Port-Based Authentication Globally Using the CLI Commands

The following table summarizes the CLI commands for enabling the port based authentication as displayed in the **Port Based Authentication Global** page.

Table 8-12. Port-Based Authentication Global CLI Commands

CLI Command	Description
<code>aaa authentication dot1x default method1 [method2]</code>	Specifies one or more AAA methods for use on interfaces running IEEE 802.1X.
<code>no aaa authentication dot1x default</code>	Use the no form of this command to restore the default configuration.
<code>dot1x system-auth-control</code>	Enables 802.1x globally.
<code>no dot1x system-auth-control</code>	Use the no form of this command to restore the default configuration.

Table 8-12. Port-Based Authentication Global CLI Commands (Continued)

CLI Command	Description
<code>dot1x system-auth-control monitor [vlan vlan-id]</code>	Enables 802.1x globally the 802.1x Monitoring mode and define the Monitor VLAN.
<code>no dot1x system-auth-control monitor</code>	Use the no format of the command to return to default.
<code>dot1x guest-vlan</code>	Contains a list of VLANs. The guest VLAN is selected from the VLAN List.
<code>no dot1x guest-vlan</code>	Use the no form of this command to disable access.
<code>show dot1x</code>	Displays 802.1X status for the device.

The following is an example of the CLI commands:

```

console(config)# aaa authentication dot1x default none
console(config)# interface vlan 5
console# show dot1x
802.1x is disabled

```

Port	Admin Mode	Oper Mode	Reauth Control	Reauth Period	Username
gil/0/1	Force Authorized	Authorized*	Disabled	3600	n/a
gil/0/2	Force Authorized	Authorized*	Disabled	3600	n/a
gil/0/3	Force Authorized	Authorized*	Disabled	3600	n/a
gil/0/4	Force Authorized	Authorized*	Disabled	3600	n/a

Port-Based Authentication Interface Settings

To configure 802.1x authentication on an interface:

- 1 Click Switching > Network Security > Dot1x Authentication > Port Based Authentication Interface Settings to display the Port Based Authentication Interface Settings: Summary page.

Figure 8-13. Port Based Authentication Interface Settings

Port Based Authentication Interface Settings: Summary

#	Port	User Name	Admin Port Control	Current Port Control	Authentication Type	Dynamic VLAN Assignment	Guest VLAN	Dynamic Policy / ACL Assignment	Periodic Reauthentication	Reauthentication Period (Sec)
1	g1/0/1		Authorized	Authorized	802.1x & UsC	Enabled		Enabled	Enabled	454
2	g1/0/2		Authorized	Authorized	802.1x Only	Disabled		Disabled	Disabled	3600
3	g1/0/3		Unauthorized	*	802.1x Only	Disabled		Disabled	Disabled	3600
4	g1/0/4		Authorized	*	802.1x Only	Disabled		Disabled	Disabled	3600
5	g1/0/5		Authorized	*	802.1x Only	Disabled		Disabled	Disabled	3600
6	g1/0/6		Authorized	*	802.1x Only	Disabled		Disabled	Disabled	3600
7	g1/0/7		Authorized	*	802.1x Only	Disabled		Disabled	Disabled	3600
8	g1/0/8		Authorized	*	802.1x Only	Disabled		Disabled	Disabled	454
9	g1/0/9		Authorized	*	802.1x Only	Disabled		Disabled	Disabled	454
10	g1/0/10		Authorized	*	802.1x Only	Disabled		Disabled	Disabled	3600
11	g1/0/11		Authorized	*	802.1x Only	Disabled		Disabled	Disabled	3600
12	g1/0/12		Authorized	*	802.1x Only	Disabled		Disabled	Disabled	3600

Port parameters for the selected unit are displayed.

- 2 Click Edit.
- 3 Select a port for which the authentication parameters apply in the **Interface** drop-down list.
- 4 Enter the parameters:
 - **User Name** — Displays the username of the port.
 - **Admin Interface Control** — Select the port authorization state. The possible options are:
 - **Auto** — Enables port-based authentication on the interface. The interface moves between an authorized or unauthorized state, based on the authentication exchange between the device and the client.

- **Authorized** — Places the interface into an authorized state without being authenticated. The interface resends and receives normal traffic without client port-based authentication.
 - **Unauthorized** — Denies the selected interface system access by moving the interface into unauthorized state. The device cannot provide authentication services to the client through the interface.
- **Current Interface Control** — Displays the current port authorization state.
 - **Authentication Type** — Select the type of authentication on the port. The possible options are:
 - **802.1x Only** — 802.1X authentication is the only authentication method performed on the port.
 - **MAC Only** — Port is authenticated, based on the supplicant MAC address. Only eight MAC-based authentications can be used on the port.
 - **802.1x & MAC** — Both 802.1X and MAC-based authentication are performed on the switch. The 802.1X authentication takes precedence.



NOTE: For MAC authentication to succeed, the RADIUS server supplicant username and password must be the supplicant MAC address. The MAC address must be in lower case letters and entered without the ":" or "-" separators; for example: 0020aa00bbcc.

- **Dynamic VLAN Assignment** — Enable/disable dynamic VLAN assignment for this port. This feature enables you to automatically assign users to VLANs during the RADIUS server authentication. When a user is authenticated by the RADIUS server, the user is automatically joined to the VLAN configured on a RADIUS server.
 - Port Lock and Port Monitor should be disabled when DVA is enabled.
 - Dynamic VLAN Assignment (DVA) can occur only if a RADIUS server is configured, and port authentication is enabled and set to 802.1x multi-session mode.
 - If the RADIUS Accept Message does not contain the supplicant's VLAN, the supplicant is rejected.

- Authenticated ports are added to the supplicant VLAN as untagged.
- Authenticated ports remain unauthenticated VLAN and Guest VLAN members. Static VLAN configuration is not applied to the port.
- The following list of VLANs cannot participate in DVA: an Unauthenticated VLAN, a Dynamic VLAN that was created by GVRP, a Voice VLAN, a Default VLAN and a Guest VLAN.
- Delete the supplicant VLAN while the supplicant is logged in. The supplicant is authorized during the next re-authentication if this supplicant VLAN is re-created, or a new VLAN is configured on the RADIUS server.



NOTE: DVA provides the same functionality as the MAC to VLAN Assignment feature, but does so in a standard way. Therefore, when DVA is available, MAC to VLAN Assignment is not available.

- **Guest VLAN** — Enable/disable port access to the Guest VLAN. If enabled, unauthorized users, connected to this interface, can access the Guest VLAN.
- **Dynamic Policy / ACL Assignment** — Enable/disable this feature.
- **Periodic Reauthentication** — Select to enable port re-authentication attempts after the specified Reauthentication Period.
- **Reauthentication Period (300-4294967295)** — Enter the number of seconds after which the selected port is reauthenticated.
- **Reauthenticate Now** — Select to enable immediate port re-authentication.
- **Authentication Server Timeout (1-65535)** — Enter the time interval that lapses before the device resends a request to the authentication server. The field value is specified in seconds.
- **Resending EAP Identity Request (1-65535)** — Enter the amount of time that lapses before EAP request are resent.
- **Quiet Period (0-65535)** — Enter the number of seconds that the device remains in the quiet state, following a failed authentication exchange.

- **Supplicant Timeout (1-65535)** — Enter the amount of time that lapses before EAP requests are resent to the supplicant. The field value is in seconds.
- **Max EAP Requests (1-10)** — Enter the maximum number of EAP requests that can be sent. If a response is not received after the defined period (supplicant timeout), the authentication process is restarted.

Enabling Port-Based Authentication on Interfaces Using the CLI Commands

The following table summarizes the CLI commands for enabling the port based authentication as displayed in the **Port Based Authentication Global** page.

Table 8-13. Port-Based Authentication Interface CLI Commands

CLI Command	Description
<code>dot1x port-control {auto force-authorized force-unauthorized}</code>	Enables manual control of the port authorization state.
<code>no dot1x port-control</code>	Use the no form of this command to restore the default configuration.
<code>dot1x mac-authentication {mac-only mac-and-802.1x}</code>	Enables authentication based on the station's MAC address.
<code>no dot1x mac-authentication</code>	Use the no form of this command to disable access.
<code>dot1x radius-attributes vlan</code>	Enables user-based VLAN assignment.
<code>no dot1x radius-attributes vlan</code>	Use the no form of this command to disable user-based VLAN assignment.
<code>dot1x guest-vlan enable</code>	Enables unauthorized users on the interface access to the guest VLAN.
<code>no dot1x guest-vlan enable</code>	Use the no form of this command to disable access.
<code>dot1x max-req count</code>	Sets the maximum number of times that the device sends an EAP to the client, before restarting the authentication process.
<code>no dot1x max-req</code>	Use the no form of this command to restore the default configuration.

Table 8-13. Port-Based Authentication Interface CLI Commands (Continued)

CLI Command	Description
dot1x re-authentication	Enables periodic re-authentication of the client.
no dot1x re-authentication	Use the no form of this command to restore the default configuration.
dot1x timeout re-authperiod <i>seconds</i>	Sets the number of seconds between re-authentication attempts.
no dot1x timeout supp-timeout	Use the no form of this command to restore the default configuration.
dot1x re-authenticate [[<i>gigabitethernet</i> <i>tengigabit ethernet</i>] <i>port-number</i>]	Manually initiates a re-authentication of all 802.1X-enabled ports or the specified 802.1X-enabled port.
dot1x timeout quiet-period <i>seconds</i>	Sets the number of seconds that the device remains in the quiet state following a failed authentication exchange.
no dot1x timeout quiet-period	Use the no form of this command to restore the default configuration.
dot1x timeout server-timeout <i>seconds</i>	Sets the time for the retransmission of packets to the authentication server.
no dot1x timeout server-timeout	Use the no form of this command to restore the default configuration.
dot1x timeout supp-timeout <i>seconds</i>	Sets the time for the retransmission of an EAP request frame to the client.
no dot1x timeout supp-timeout	Use the no form of this command to restore the default configuration.
dot1x timeout tx-period <i>seconds</i>	Sets the number of seconds that the device waits for a response to an EAP - request/identity frame, from the client, before resending the request.
no dot1x timeout tx-period	Use the no form of this command to restore the default configuration.
show dot1x [[<i>gigabitethernet</i> <i>tengigabit ethernet</i>] <i>port-number</i>]	Displays 802.1X status for the device or for the specified interface.

Table 8-13. Port-Based Authentication Interface CLI Commands (Continued)

CLI Command	Description
show dot1x advanced	Displays 802.1X advanced features for the switch or specified interface.
show dot1x users [username username]	Displays 802.1X users for the device.
dot1x guest-vlan enable no dot1x guest-vlan enable	Enables using a guest VLAN for unauthorized ports. Use the no form of this command to restore the default configuration.

The following is an example of the CLI commands:

```

console(config)# aaa authentication dot1x default none
console(config)# interface vlan 5
console(config-if)# dot1x auth-not-req
console(config)# vlan database
console(config-vlan)# vlan 2
console(config-vlan)# exit
console(config)# interface vlan 2
console(config-if)# dot1x guest-vlan
console# show dot1x

```

Interface	Admin Mode	Oper Mode	Reauth Control	Reauth Period	Username
-----	-----	-----	-----	-----	-----
gil/0/1	Auto	Authorized	Enabled	3600	Bob
gil/0/2	Auto	Authorized	Enabled	3600	John
gil/0/3	Auto	Unauthoriz ed	Enabled	3600	Clark
gil/0/4	Force- auth	Authorized	Disabled	3600	n/a

Monitoring Users

Use the **Monitoring Users** page to view rejected users.

- 1 Click **Switching > Network Security > Dot1 Authentication > Monitoring Users** to display the **Monitoring Users** page.

Figure 8-14. Monitoring Users

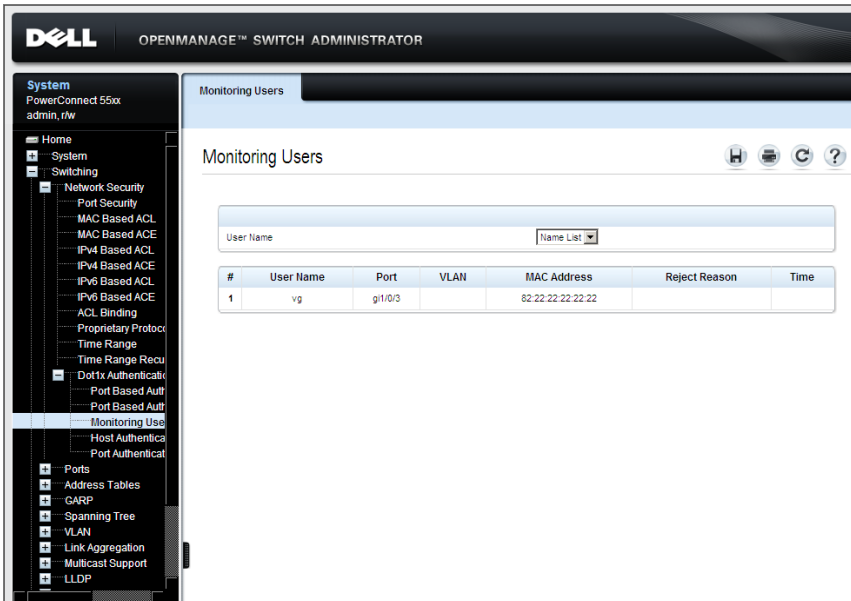

- 2 Select a supplicant that was authenticated on the port. The supplicant's information is displayed.
 - **User Name** — Name assigned to this port.
 - **Port** — Number of port.
 - **VLAN** — Port belongs to this VLAN.
 - **MAC Address** — Source of traffic.
 - **Reject Reason** — Reason that traffic was rejected. See Table 8-14 for a list of the possible reject reasons.
 - **Time** — Time that traffic was rejected.

Table 8-14. Reject Reason Description

Abbreviation	Description
ACL-DEL	ACL was deleted by a user.
ACL-NOTEXST	ACL sent by the RADIUS server does not exist on the device.
ACL-OVRFL	ACL sent by the RADIUS server cannot be applied because of TCAM overflow.
AUTH-ERR	Rejected by RADIUS due to wrong user name or password in the RADIUS server.
FLTR-ERR	RADIUS accept message contains more than two filter IDs.
FRS-MTH-DENY	First method is deny .
IPv6WithMAC	RADIUS accept message contains filter with IPv6 DIP and MAC addresses.
IPV6WithNotIP	RADIUS accept message contains IPv6 and not IP simultaneously.
POL-BasicMode	Policy is not supported in the QoS basic mode.
POL-DEL	Policy was deleted by a user.
POL-OVRFL	Policy sent by radius server can not be applied because of TCAM overflow.
RAD-APIERR	RADIUS API returned error (e.g. No RADIUS server is configured).
RAD_INVLRES	RADIUS server returned invalid packet (e.g. EAP attribute is missing).
RAD-NORESP	RADIUS server is not responding.
VLAN-DFLT	VLAN sent by a RADIUS server cannot be applied because it is the default VLAN.
VLAN-DYNAM	VLAN sent by RADIUS server cannot be applied because it is a dynamic VLAN.
VLAN-GUEST	VLAN sent by RADIUS server cannot be applied because it is the Guest VLAN.

Monitoring Users Using the CLI Commands

The following table summarizes the CLI commands for monitoring users:

Table 8-15. Monitoring Users CLI Commands

CLI Command	Description
show dot1x monitoring result [<i>username username</i>]	Displays the captured information of each interface/host on the switch/stack.

The following is an example of the CLI commands:

```
console# show dot1x monitoring Tom
Username: Tom
Port g1
Quiet period: 60 Seconds
Tx period: 30 Seconds
Max req: 2
Supplicant timeout: 30 Seconds
Server timeout: 30 Seconds
Session Time (HH:MM:SS): 08:19:17
MAC Address: 00:08:78:32:98:78
Authentication Method: Remote
Assigned VLAN: 207
Reason for Failure:VLAN was not defined on Switch
```

Host Authentication

Use the **Host Authentication** page to define the authentication mode on the port, and the action to perform if a violation is detected.

To view ports and their authentication information:

- 1 Click **Switching > Network Security > Dot1 Authentication > Host Authentication** to display the **Host Authentication: Summary** page.

Figure 8-15. Host Authentication: Summary

The screenshot shows the Dell OpenManage Switch Administrator interface. The left sidebar contains a navigation tree with the following items: System, PowerConnect 55xx, admin, r/w, Home, System, Switching, Network Security, Port Security, MAC Based ACL, MAC Based ACE, IPv4 Based ACL, IPv4 Based ACE, IPv6 Based ACL, IPv6 Based ACE, ACL Binding, Proprietary Protocol, Time Range, Time Range Recu, Dot1x Authentication, Port Based Auth, Port Based Auth, Monitoring User, Host Authentication, Port Authentication, Ports, Address Tables, GARP, Spanning Tree, VLAN, Link Aggregation, Multicast Support, and LLDP. The main content area is titled 'Host Authentication' and has tabs for 'Summary' and 'Edit'. Below the tabs is the heading 'Host Authentication : Summary' and a 'Unit ID' dropdown menu set to '1'. A table displays the following data:

#	Port	Host Authentication	Action on Violation	Single Host Status	Number of Violations
1	g1/0/1	Multiple Host	Shutdown	No Single-host	0
2	g1/0/2	Single	Discard	Not in auto mode	0
3	g1/0/3	Single	Discard	Not in auto mode	0
4	g1/0/4	Multiple Host	Forward	No Single-host	0
5	g1/0/5	Single	Discard	Unauthorized	0
6	g1/0/6	Single	Discard	Unauthorized	0
7	g1/0/7	Single	Discard	Unauthorized	0
8	g1/0/8	Single	Discard	Unauthorized	0
9	g1/0/9	Single	Discard	Unauthorized	0
10	g1/0/10	Single	Discard	Unauthorized	0
11	g1/0/11	Single	Discard	Unauthorized	0
12	g1/0/12	Single	Discard	Unauthorized	0
13	g1/0/13	Single	Discard	Unauthorized	0
14	g1/0/14	Multiple-Session	Forward	No Single-host	0

A list of the ports and their authentication modes is displayed. The fields are defined on the **Edit** page with the exception of the following field:

- **Single Host Status** — Displays the host status. The possible options are:
 - **Unauthorized** — The port control is **Force Unauthorized**, the port link is down or the port control is **Auto**, but a client has not been authenticated via the port.

- Not in Auto Mode — The port control is **Forced Authorized**, and clients have full port access.
 - Single-host Lock — The port control is **Auto** and a single client has been authenticated via the port.
 - **No Single Host** — Multiple Host is enabled.
- **Number of Violations** — Displays the number of packets that arrive on the interface in single-host mode, from a host whose MAC address is not the supplicant MAC address.

2 Click **Edit**.

3 In the **Port** drop-down list, select the port to which you want to apply the authentication mode.

4 Enter the fields:

- **Host Authentication** — Define the host authentication type. The options are:
 - **Single** — Only a single authorized host can access the port. (Port Security cannot be enabled on a port in single-host mode.)
 - **Multiple Host** — Multiple hosts can be attached to a single 802.1x-enabled port. Only the first host must be authorized, and then the port is wide-open for all who want to access the network. If the host authentication fails, or an EAPOL-logoff message is received, all attached clients are denied access to the network.
 - **Multiple Session** — A number of specific authorized hosts may access the port. Each host is treated as if it was the first and only user and must be authenticated. Filtering is based on the source MAC address.
- **Action on Single Host Violation** — Select the action to be applied to packets arriving in Single Session/Single Host mode, from a host whose MAC address is not the supplicant MAC address. The options are:
 - **Discard** — Discard the packets from any unlearned source.
 - **Forward** — Forward the packets from an unknown source, however, the MAC address is not learned.

- **Shutdown** — Discard the packet from any unlearned source and shut down the port. Ports remain shutdown until they are activated, or the switch is reset.

Host Authentication pages:

Table 8-16. Host Authentication CLI Commands

CLI Command	Description
<code>dot1x host-mode {multi-host single-host multi-sessions}</code>	Allows a single host (client) or multiple hosts on an IEEE 802.1x-authorized port.
<code>dot1x traps mac-authentication failure</code> <code>no dot1x traps mac-authentication failure</code>	Enables sending traps when a MAC address is successfully authenticated by the 802.1X mac-authentication access control. Use the no form of this command to disable the traps.
<code>dot1x traps mac-authentication success</code> <code>no dot1x traps mac-authentication success</code>	Enables sending traps when MAC address was failed in authentication of the 802.1X MAC authentication access control. Use the no form of this command to disable the traps.
<code>dot1x violation-mode {restrict protect shutdown}</code> <code>no dot1x violation-mode</code>	Configures the action to be taken, when a station whose MAC address is not the supplicant MAC address, attempts to access the interface. Use the no form of this command to return to default.
<code>show dot1x advanced [gigabitethernet tengigabite thernet] port-number]</code>	Displays 802.1x advanced features for the device or specified interface.

The following is an example of the CLI commands:

```
console(config)# interface gil/0/1
console(config-if)# dot1x host-mode multi-host
console(config-if)# dot1x host-mode single-host
console(config-if)# dot1x host-mode multi-sessions
```

Port Authentication Users

The **Port Authentication Users** page enables you to view users that attempted to be authenticated.

To view ports and their authentication definitions:

- 1 Click **Switching > Network Security > Dot1 Authentication > Port Authentication Users** to display the **Port Authentication Users** page.

Figure 8-16. Port Authentication Users

#	User Name	Port	Session Time	Authentication Method	MAC Address	VLAN	Filter	Details
1	vg	g1/0/3	00:00:22		82:22:22:22:22:22		OK	Details
2	iu	g1/0/4	00:13:54		86:22:22:22:22:22		Warning	Details

The ports and their authentication definitions are displayed.

- **User Name** — Supplicant names that were authenticated on each port.
- **Port** — Number of port.
- **Session Time** — Amount of time (in seconds) that the supplicant was logged on the port.

- **Authentication Method** — Method by which the last session was authenticated. The options are:
 - **None**—No authentication is applied; it is automatically authorized.
 - **RADIUS**—Supplicant was authenticated by a RADIUS server.
 - **MAC Address**—Displays the supplicant MAC address.
 - **MAC Address** — MAC address of user who attempted to be authenticated.
 - **VLAN** — VLAN assigned to the user.
 - **Filter** — Filter that was applied to the user by receiving the policy/ACL name from the RADIUS server (Dynamic ACL Assignment).
- 2** Click **Details** to view the names of the VLAN filters (**Filter #1** and **Filter #2**) defined on the port, in addition to the above fields.

Display Port Authentication Users Using the CLI Commands

The following table summarizes the CLI commands for displaying port authentication users:

Table 8-17. Display Port Authentication Users CLI Commands

CLI Command	Description
<code>show dot1x users</code>	Displays active 802.1x authenticated users for the device.

The following is an example of the CLI commands:

```
console# show dot1x users
Port    User Session      Auth   MAC           VLAN Filter
      Name Time          Method Address
-----
gil/0/1 Bob  1d 03:08:58 Remote 0008.3b79.8787 3
Port    User Session      Auth   MAC           VLAN Filter
      Name Time          Method Address
-----
gil/01  Bob  1d 09:07:38 Remote 0008.3b79.8787 3 OK
gil/01  Tim  03:08:58 Remote 0008.3b79.3232 9 OK
gil/03  Paul 02:12:48 Remote 0008.3b89.8237 8 Warning
console# show dot1x users username Bob
Port    User Session      Auth   MAC           VLAN Filter
      Name Time          Method Address
-----
gil/01  Bob  1d 09:07:38 Remote 0008.3b79.8787 3 OK
```

Configuring System Information

This section describes how to set system parameters, such as security features, switch software, system time, logging parameters and more.

It contains the following topics:

- General Switch Information
- Time Synchronization
- Logs
- IP Addressing
- Diagnostics
- Management Security
- DHCP Server
- DHCP Server
- File Management
- Stack Management
- sFlow

General Switch Information

This section describes how to view and set general switch parameters.

It contains the following topics:

- Asset Information
- System Health
- Power over Ethernet

Asset Information

Use the Asset page to view and configure general device information, including the system name, location, contact, system MAC Address, System Object ID, date, time, and system up time.

To configure general device parameters:

- 1 Click **System > General > Asset** in the tree view to display the Asset page.

Figure 9-1. Asset

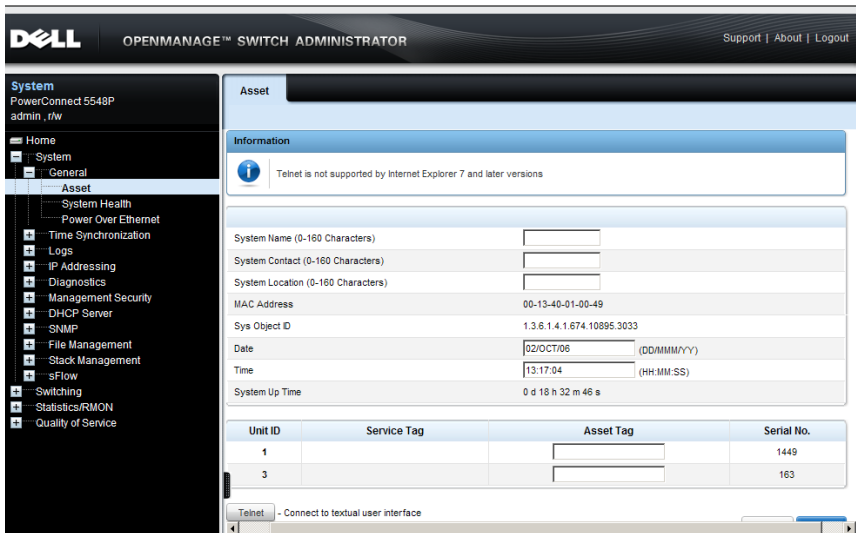

- 2** Enter/view the parameters:
 - **System Name (0-159 Characters)** — Enter the user-defined device name.
 - **System Contact (0-159 Characters)** — Enter the name of the contact person.
 - **System Location (0-159 Characters)** — Enter the location where the system is currently running.
 - **MAC Address** — Displays the device MAC address.
 - **Sys Object ID** — Displays the vendor's authoritative identification of the network management subsystem contained in the entity.
 - **Date** — Enter the current date (mandatory). This date can also be entered in the **Manual Time Settings** page. If SNTP has been defined, but the SNTP server is not available, the switch uses the date and time in this field and the **Time** field.
 - **Time** — Enter the current time (mandatory). This time can also be entered in the **Manual Time Settings** page. If SNTP has been defined, but the SNTP server is not available, the switch uses the date and time in this field and the **Date** field.
 - **System Up Time** — Displays the amount of time since the last device reset.
- 3** For each unit in the stack (displayed in **Unit No.**), the following information is displayed:
 - **Service Tag** — Displays the service reference number used when servicing the device.
 - **Asset Tag** — Enter the device asset tag.
 - **Serial No.** — Displays the device serial number.
- 4** Enter the **Asset Tag (0-16 Characters)** for each unit in the stack. This is the user-defined reference for the unit.

Entering Asset Information Using the CLI Commands

The following table summarizes the CLI commands for entering fields displayed on the Asset page.

Table 9-1. Asset CLI Command

CLI Command	Description
snmp-server contact <i>text</i> no snmp-server contact	Configures the system contact (sysContact) name. Use the no form of the command to remove the system contact information.
snmp-server location <i>text</i> no snmp-server location	Configures the system location string. Use the no form of this command to remove the location string.
hostname <i>name</i> no hostname	Specifies the device host name. Use the no form of the command to remove the existing host name.
clock set <i>hh:mm:ss</i> <i>{month day} year</i>	Sets the system clock to this time.
asset-tag [<i>unit unit</i>] <i>tag</i> no asset-tag [<i>unit unit</i>]	Assigns the asset tag to the unit. Removes the asset tag from the unit.

The following is an example of the CLI commands

console	(config)#	asset-tag	2365491870
---------	-----------	------------------	------------

System Health

To view the device's power information and set fan administration state:

- 1 Click **System > General > System Health** in the tree view to display the System Health page.

Figure 9-2. System Health

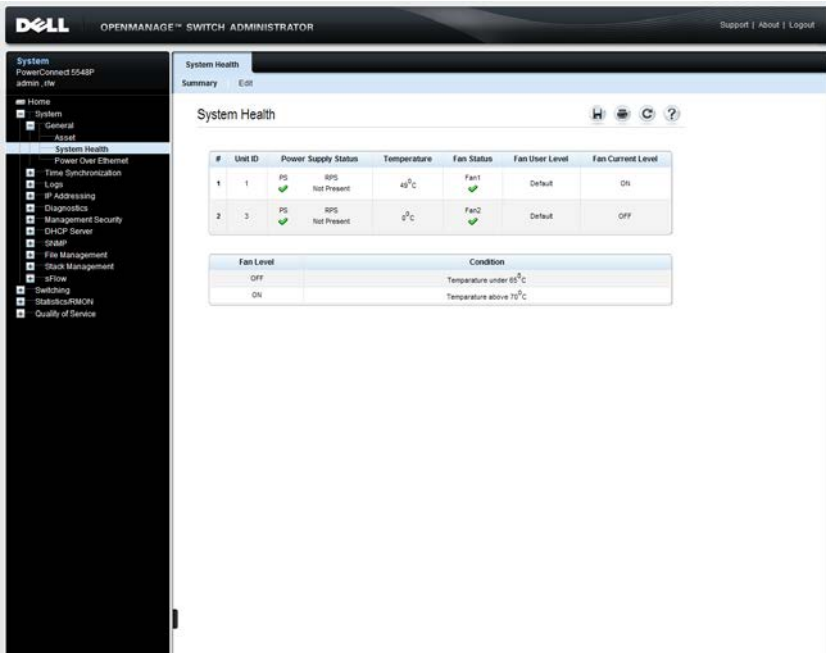





The System Health page displays the following fields:

- **Unit No.** — The unit in the stack for which information is displayed.

Power Supply Status —Displays the following columns:

- **PS** — The power status of the internal power unit. The possible options are:
 - **Checked** — The power supply is operating normally.
 - **Unchecked** — The power supply is not operating normally.
 - **Not Present** — The power supply is currently not present.

- **RPS** — The device has one of two auxiliary power supplies: Redundant Power Supply (RPS) for non-PoE devices and Modular Power Supply (MPS) for PoE devices. Only one of these may be present at one time. For each type of power supply, the possible options are:
 -  **Checked** — The power supply is operating normally.
 -  **Unchecked** — The power supply is not operating normally.
 - **Not Present** — The power supply is currently not present.
 - **Temperature** — Displays the temperature on the device.
 - **Fan Status** — The device has two fans. The device constantly measures the internal temperature, and powers the fans on/off according to the temperature. The user can set the fans to be constantly on. The possible options are:
 -  **Checked** — The fans are operating normally.
 -  **Unchecked** — At least one of the fans is not operating normally.
 - **Fan Admin State** — On/Auto status that user configured in the **Edit** page.
 - **Fan Current Level** — Specifies whether the fan is actually on or off.
- 2** The lower block displays the condition under which a fan will be turned on or off.
- **Fan Level** — The on or off level.
 - **Condition** — The temperature at which the fans will be turned on or off. The device temperature is displayed in Celsius. The device temperature threshold is 40 C (104 F). Table 11-2 displays the temperature in Fahrenheit in increments of 5.
-  **NOTE:** It is recommended to leave Fan User Level at Auto so that the fans operate according to the temperature of the switch.
- 3** To control the fans on a unit, or set the default value, click **Edit**, and enter the fields:
- **Unit ID** — Select the unit ID whose fan will be adjusted.

- **Fan Admin State** — Set one of the options:
 - **Auto** — Fans are turned on when the internal temperature of the switch is higher than the threshold displayed on the **Summary** page in the **Condition** field.
 - **ON** — Turns fan on under all conditions

Table 9-2. Celsius to Fahrenheit Conversion Table

Celsius	Fahrenheit
0	32
5	41
10	50
15	59
20	68
25	77
30	86
35	95
40	104

Viewing System Health Information Using the CLI Commands

The following table summarizes the CLI commands for viewing fields displayed on the **System Health** page.

Table 9-3. System Health CLI Command

CLI Command	Description
show system [unit <i>unit</i>]	Displays system information.
system fans always-on [unit <i>unit</i>]	Sets the system fans to On regardless of device temperature.
no system fans always-on	Use the no form of the command to return to default
show system fans	Displays the fans' status.

The following is an example of the CLI commands:

```
console# show system
Unit          Type
-----
2            PowerConnect 5548
Unit Main Power Supply Redundant Power Supply
-----
2            OK
Unit Fans Status
-----
2            OK
Unit Temperature (Celsius) Temperature Sensor Status
-----
2            41            OK
Unit Up time
-----
2            02,00:03:32
```

Power over Ethernet

A Power over Ethernet (PoE) switch is a type of PSE (Power Sourcing Equipment) that delivers electrical power to connected Powered Devices (PDs) over existing copper cables, without interfering with the network traffic, updating the physical network or modifying the network infrastructure.

Using PoE eliminates the need to:

- Place all network devices next to power sources.
- Deploy double-cabling systems, significantly decreasing installation costs.

PoE can be used in any network that deploys relatively low-powered devices connected to the Ethernet LAN. PDs are devices that receive power from the PowerConnect power supplies, such as:

- IP phones

- Wireless access points
- IP gateways
- Audio and video remote monitoring devices

PDs are connected to the device via the Gigabit ports.

To configure PoE parameters on devices equipped with PoE:

- 1 Click **System > General > Power over Ethernet** in the tree view to display the **Power Over Ethernet: Summary** page.

Figure 9-3. Power Over Ethernet: Summary

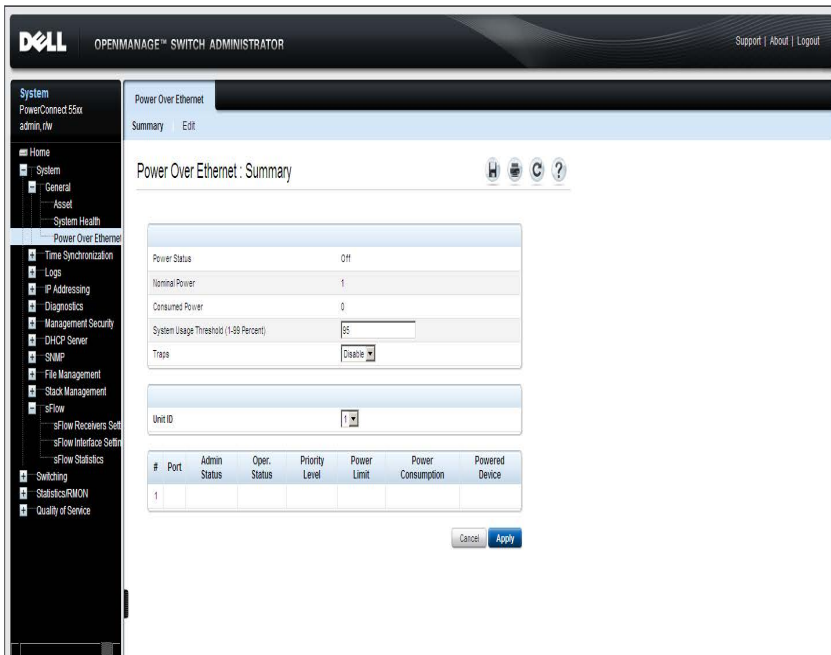

- 2 The PoE global parameters are displayed:
 - **Power Status** — The inline power source status.
 - **On** — The power supply unit is functioning.
 - **Off** — The power supply unit is not functioning.

- **Faulty** — The power supply unit is functioning, but an error has occurred, for example, a power overload or a short circuit.
 - **Nominal Power** — The actual amount of power the device can supply, in watts.
 - **Consumed Power** — The amount of the power used by the device, in watts.
- 3** Enter the following parameters:
- **System Usage Threshold (1-99 Percent)** — Enter the percentage of power consumed before a trap is generated.
 - **Traps** — Enable/disable traps if system usage goes over the threshold. The possible options are:
 - **Enable** — Enables PoE traps on the device. If traps are enabled, you must also enable SNMP, and configure at least one SNMP notification recipient.
 - **Disable** — Disables PoE traps on the device.
- 4** To view PoE port settings for a unit in the stack, select its **Unit ID**. The port PoE parameters are displayed for all ports on the unit. The fields displayed in this block are described in the **Edit** page.
- 5** To set PoE settings for a port, click **Edit**.
- 6** Select a port in the **Port** field, and enter the following PoE parameters for the PDs connected to this port.
- **PoE Admin Status** — Select the device PoE mode. The possible options are:
 - **Auto** — Enables the Device Discovery protocol, and provides power to the device using the PoE unit. The Device Discovery Protocol enables the device to discover Powered Devices attached to the device interfaces, and to learn their classification.
 - **Never** — Disables the Device Discovery protocol, and stops the power supply to the device using the PoE module.
 - **Power Priority Level** — Enter the priority that determines the power that is used if the power supply is from **Critical** to **Low**. If, for example, the power supply is running at 99% usage, and port 1 is prioritized as **Critical**, but port 3 is prioritized as **Low**, port 1 is will receive power before port 3.

- **Power Limit (0-15.4)** — Enter the maximum amount of power that the PoE unit may deliver to this port.
- **Powered Device (0-24 characters)** — Enter a user-defined description of the PD connected to the port, such as: "Bob Smith's telephone".

The following fields are displayed on this page:

- **PoE Operational Status** — Whether the port is currently providing power. If it is not providing power, the reason is displayed.
- **Power Consumption** — The amount of power being consumed by the powered device.
- **Overload Counter** — Total power overload occurrences.
- **Short Counter** — Total power shortage occurrences.
- **Denied Counter** — Number of times the powered device was denied power.
- **Absent Counter** — Number of times the power supply was stopped to the PD because it was no longer detected. f
- **Invalid Signature Counter** — Number of times an invalid signature was received. Signatures are the means by which the powered device identifies itself to the PSE. Signatures are generated during powered device detection, classification, or maintenance.

Managing PoE Using the CLI Commands

The following table describes the CLI commands for viewing fields displayed on the **Power Over Ethernet** pages.

Table 9-4. Power Over Ethernet CLI Commands

CLI Command	Description
<code>power inline {auto never}</code>	Configures the administrative status of the inline power on an interface.
<code>power inline powered-device pd-type</code>	Adds a description of the powered device type. Use the no version of the command to remove the description.
<code>no power inline powered- device</code>	Use the no form of this command to restore the default configuration.

Table 9-4. Power Over Ethernet CLI Commands (Continued)

CLI Command	Description
power inline priority { <i>critical</i> <i>high</i> <i>low</i> }	Configures the priority of the interface from the point of view of inline power management.
no power inline priority	Use the no form of this command to restore the default configuration.
power inline usage-threshold	Configures the threshold for triggering alarms.
no power inline usage-threshold	Use the no form of this command to restore the default configuration.
power inline traps enable	Enables PoE device traps.
no power inline traps enable	Use the no form of this command to disable traps.
power inline limit-mode { <i>class</i> <i>port</i> }	Sets the power limit mode of the system.
no power inline limit-mode	Use the no form of this command to return to default.
show power inline [[[<i>gigabitethernet</i> <i>tengigabitethernet</i>] <i>port-number</i> <i>vlan</i> <i>vlan-id</i> <i>port-channel</i> <i>LAG-number</i>]/ <i>module</i> <i>stack-member-number</i>]	Displays PoE configuration information for all interfaces or for a unit in the stack.

The following is an example of the CLI commands:

```

console# show power inline
Unit  Power  Nominal Power  Consumed Power  Usage Threshold  Traps
-----
 1    Off    1 Watts       0 Watts (0%)   95               Disable
 2    Off    1 Watts       0 Watts (0%)   95               Disable
 3    Off    1 Watts       0 Watts (0%)   95               Disable
 4    Off    1 Watts       0 Watts (0%)   95               Disable
    
```

Time Synchronization

The system clock runs from the moment the system starts up, and keeps track of the date and time.

The date and time may be either set manually, or it may be received from an SNTP server.

This section describes how to set system time, and contains the following sections:

- Manual Time Settings
 - Setting System Time and Daylight Savings Time
 - CLI Commands for Setting Manual Time
- System Time from an SNTP Server
 - Global Settings (Clock Source)
 - SNTP Global Settings
 - SNTP Authentication
 - SNTP Servers
 - SNTP Interfaces
 - CLI Script for Receiving Time from an SNTP Server

Manual Time Settings

This section describes how to set the system time manually on the device.

It contains the following topics:

- Setting System Time and Daylight Savings Time
- CLI Commands for Setting Manual Time

Setting System Time and Daylight Savings Time

Use the **Manual Time Settings** page to set system date/time manually (as opposed to receiving them from an external SNTP server). For more information on SNTP, see "System Time from an SNTP Server" on page 170.

If system time is kept using an external SNTP clock, and the external SNTP clock fails, the system time reverts to the time set here or in the **Asset** page.

In addition to setting the local clock, you can use this page to enable Daylight Savings Time (DST) on the device.

The following is a list of DST start and end times in various countries:

- **Albania** — Last weekend of March until the last weekend of October.
- **Australia** — From the end of October until the end of March.
- **Australia - Tasmania** — From beginning of October until the end of March.
- **Armenia** — Last weekend of March until the last weekend of October.
- **Austria** — Last weekend of March until the last weekend of October.
- **Bahamas** — From April to October, in conjunction with U.S. summer hours.
- **Belarus** — Last weekend of March until the last weekend of October.
- **Belgium** — Last weekend of March until the last weekend of October.
- **Brazil** — From the 3rd Sunday in October until the 3rd Saturday in March. During the period of Daylight Saving Time, Brazilian clocks go forward one hour in most of the Brazilian southeast.
- **Chile** — Easter Island 9th March 12th October. The first Sunday in March or after 9th March.
- **China** — China does not operate Daylight Saving Time.
- **Canada** — From the first Sunday in April until the last Sunday of October. Daylight Saving Time is usually regulated by provincial and territorial governments. Exceptions may exist in certain municipalities.
- **Cuba** — From the last Sunday of March to the last Sunday of October.
- **Cyprus** — Last weekend of March until the last weekend of October.
- **Denmark** — Last weekend of March until the last weekend of October.
- **Egypt** — Last Friday in April until the last Thursday in September.

- **Estonia** — Last weekend of March until the last weekend of October.
- **Finland** — Last weekend of March until the last weekend of October.
- **France** — Last weekend of March until the last weekend of October.
- **Germany** — Last weekend of March until the last weekend of October.
- **Greece** — Last weekend of March until the last weekend of October.
- **Hungary** — Last weekend of March until the last weekend of October.
- **India** — India does not operate Daylight Saving Time.
- **Iran** — From 1st Farvardin until the 1st Mehr.
- **Iraq** — From 1st April until 1st October.
- **Ireland** — Last weekend of March until the last weekend of October.
- **Israel** — Varies year-to-year.
- **Italy** — Last weekend of March until the last weekend of October.
- **Japan** — Japan does not operate Daylight Saving Time.
- **Jordan** — Last weekend of March until the last weekend of October.
- **Latvia** — Last weekend of March until the last weekend of October.
- **Lebanon** — Last weekend of March until the last weekend of October.
- **Lithuania** — Last weekend of March until the last weekend of October.
- **Luxembourg** — Last weekend of March until the last weekend of October.
- **Macedonia** — Last weekend of March until the last weekend of October.
- **Mexico** — From the first Sunday in April at 02:00 to the last Sunday in October at 02:00.
- **Moldova** — Last weekend of March until the last weekend of October.
- **Montenegro** — Last weekend of March until the last weekend of October.
- **Netherlands** — Last weekend of March until the last weekend of October.
- **New Zealand** — From the first Sunday in October until the first Sunday on or after 15th March.
- **Norway** — Last weekend of March until the last weekend of October.
- **Paraguay** — From 6th April until 7th September.
- **Poland** — Last weekend of March until the last weekend of October.
- **Portugal** — Last weekend of March until the last weekend of October.

- **Romania** — Last weekend of March until the last weekend of October.
- **Russia** — From the 29th March until the 25th October.
- **Serbia** — Last weekend of March until the last weekend of October.
- **Slovak Republic** — Last weekend of March until the last weekend of October.
- **South Africa** — South Africa does not operate Daylight Saving Time.
- **Spain** — Last weekend of March until the last weekend of October.
- **Sweden** — Last weekend of March until the last weekend of October.
- **Switzerland** — Last weekend of March until the last weekend of October.
- **Syria** — From 31st March until 30th October.
- **Taiwan** — Taiwan does not operate Daylight Saving Time.
- **Turkey** — Last weekend of March until the last weekend of October.
- **United Kingdom** — Last weekend of March until the last weekend of October.
- **United States of America** — From the second Sunday of March at 02:00 to the first Sunday of November at 02:00.

To manually set the device time:

- 1 Click **System > Time Synchronization > Manual Time Settings** in the tree view to display the **Manual Time Settings** page.

Figure 9-4. Manual Time Settings

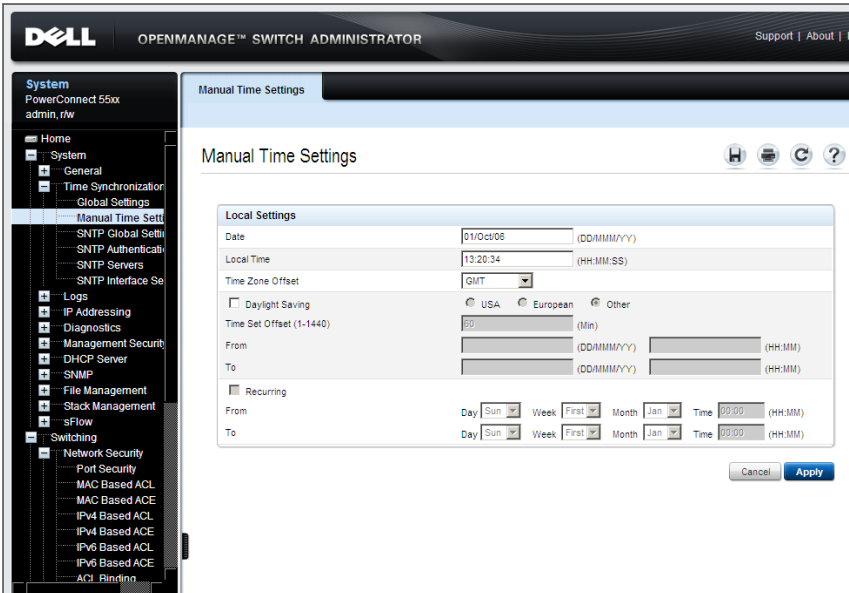

- 2 Enter the following local settings:
 - **Date** — The system date.
 - **Local Time** — The system time.
 - **Time Zone Offset** — The difference between Greenwich Mean Time (GMT) and local time. For example, the Time Zone Offset for Paris is GMT +1:00, while the local time in New York is GMT –5:00.
- 3 To set Daylight Savings Time (DST), select the **Daylight Savings** field and select one of the possible options:
 - **USA** — The device switches to DST at 2 a.m. on the second Sunday of March, and reverts to standard time at 2 a.m. on the first Sunday of November.

- **European** — The device switches to DST at 1:00 am on the last Sunday in March, and reverts to standard time at 1:00 am on the last Sunday in October. The **European** option applies to EU members, and other European countries using the EU standard.
- **Other** — Specifies that you will set DST manually in the fields described below.

If you selected **USA** or **European** you are finished. If you selected **Other**, proceed to the next step.

There are two types of DST possible when **Others** is selected. You can set a specific date in a particular year, or you can set a recurring setting, irrespective of the year. For a specific setting in a particular year, complete the **Daylight Savings** area, and for a recurring setting, complete the **Recurring** area.

If **Other** is selected, the **From** and **To** fields must be defined either in the **Non-recurring** or **Recurring** section.

4 To enter non-recurring DST parameters, enter the following fields:

- **From** — The time that DST begins. The possible options are:
 - **DD/MMM/YY** — The date, month, and year at which DST begins.
 - **HH/MM** — The time (hour and minutes) at which DST begins.
- **To** — The time that DST ends. The possible options are:
 - **DD/MMM/YY** — The date, month, and year at which DST ends.
 - **HH/MM** — The time (hour and minutes) at which DST ends.

5 To enter recurring DST parameters, select **Recurring** and enter the following fields:

- **From** — The time that DST begins each year, for example, DST begins locally every second Sunday in April at 5:00 am. The possible options are:
 - **Day** — The day of the week from which DST begins every year.
 - **Week** — The week within the month from which DST begins every year.
 - **Month** — The month of the year in which DST begins every year.

- **Time** — The time at which DST begins every year.
- **To** — The recurring time that DST ends each year, for example, DST ends locally every fourth Friday in October at 5:00 am. The possible options are:
 - **Day** — The day of the week at which DST ends every year.
 - **Week** — The week within the month at which DST ends every year.
 - **Month** — The month of the year in which DST ends every year.
 - **Time** — The time at which DST ends every year.

CLI Commands for Setting Manual Time

The following steps (in any order) must be completed before setting time manually:

- Set system time
- Define the time zone in relation to GMT.
- Configure Daylight Savings Time.

The following table summarizes the CLI commands for setting fields displayed in the **Manual Time Setting** pages when the clock source is **Local**.

Table 9-5. Manual Time Setting CLI Commands

CLI	Description
<code>clock set hh:mm:ss { [day month] [month day] } year</code>	Set the system clock to this time.
<code>clock summer-time zone recurring {usa eu} {week day month hh:mm week day month hh:mm} [offset]</code>	Configures the system to automatically switch to summer time (according to the USA and European standards) every year on a recurring basis.

Table 9-5. Manual Time Setting CLI Commands (Continued)

CLI	Description
clock summer-time zone date <i>date month year hh:mm</i> <i>date month year hh:mm</i> [<i>offset</i>]	Configures the system to automatically switch to summer time (Daylight Savings Time) for a specific period - date/month/year format.
clock summer-time zone date <i>month date year hh:mm</i> <i>month date year hh:mm</i> [<i>offset</i>]	Use the no form of the command to configure the system not to switch to summer time (Daylight Savings Time).
no clock summer-time	
clock timezone zone hours- <i>offset</i> [<i>minutes offset</i>]	Sets the time zone and names it "zone" for display purposes.
show clock	Displays the time and date from the system clock.

A sample script to set system time manually is shown below

Table 9-6. CLI Script to Set Manual System Time

CLI	Description
<code>Console# clock set 13:32:00 7 Nov 2010</code>	Set the system time.
<code>console# configure</code>	
<code>console(config)# clock timezone Ohio +2</code>	Set the time zone to GMT plus 2 hours. The name of the zone "Ohio" is purely for documentation purposes. This is not mandatory for manual time, but is recommended. It enables anyone seeing the time to know what that time is in respect to their timezone.
<code>console(config)# clock summer-time Ohio_Summer recurring usa</code>	Set Daylight Savings Time such that it recurs every year and is based on the summer time schedule of the USA. The name of the zone "Ohio_Summer" is for documentation purposes only.
<code>console(config)# exit</code>	
<code>console# show clock</code>	Display the system time.

System Time from an SNTP Server

This section describes how to receive date/time from an SNTP server.

It contains the following topics:

- SNTP Overview
- SNTP Global Settings
- SNTP Authentication
- SNTP Servers
- SNTP Interfaces

SNTP Overview

The switch supports the Simple Network Time Protocol (SNTP), which provides accurate network switch clock time synchronization of up to 100 milliseconds. The implementation of SNTP is based on SNTPv4 (RFC 2030).

SNTP is a simple and lighter version of NTP, and can be used when the ultimate performance of the full NTP implementation, described in RFC-1305, is not required. SNTP operates with NTP, thus an SNTP client can work with both SNTP and NTP servers.

The switch operates only as a client, and cannot provide time services to other systems.

SNTP Server Types

The switch can accept time information from the following server types:

- **Unicast**

Polling for Unicast information is used for polling a server whose IP address is known. This is the preferred method for synchronizing device time, as it is most secure.

Up to eight SNTP servers can be defined.

If this method is selected, SNTP information is accepted only from SNTP servers defined in the **SNTP Servers** page.

Time levels T1 - T4 (see the "Algorithm for Selecting Designated SNTP Server" on page 173 section) are used to determine from which server time information is accepted.

If Unicast polling is not enabled or if no servers are defined on the device, the device accepts time information from any SNTP server of the type that is enabled, which responds.

- **Anycast**

Polling for Anycast information is used when the SNTP server's IP address is not defined or it cannot be reached. If this method is enabled, time information can be received from any SNTP server on the network. The

device time and date are synchronized when it proactively requests synchronization information.

Anycast polling to get time information is preferable to Broadcast polling, because it is more secure.

Time levels T3 and T4 are used to determine from which server time information is accepted.

- **Broadcast**

Broadcast information is used if receiving Broadcast packets has been enabled, and one of the following situations occurs:

- The SNTP server IP address has not been defined.
- Several time-information packets are received and the Broadcast time is best according to the algorithm defined in "Algorithm for Selecting Designated SNTP Server" on page 173.

Broadcast is the least secure method of receiving time, because it is both unsecured and the time information was not specifically requested by the device. Anycast is also unsecured, but time-information packets are only accepted if they were requested.

Stratums

Each SNTP server is characterized by stratums, which define the accuracy of its clock. The stratum is the distance, in terms of NTP hops, from the most authoritative time server. The lower the stratum (where zero is the lowest), the more accurate the clock. The switch accepts time from stratum 1 and above.

The following provides examples of clocks from various stratums:

- **Stratum 0** — A real time clock is used as the time source, for example, a GPS system.
- **Stratum 1** — A server that is directly linked to a Stratum 0 time source is used.
- **Stratum 2** — The time source is distanced from the Stratum 1 server over a network path, for example, a Stratum 2 server receives the time over a network link, via NTP, from a Stratum 1 server.

Algorithm for Selecting Designated SNTP Server

Messages received from SNTP servers are logged, until there are three responding servers, or the timer expires. In any event, when the third message is received, the timer expires.

A server is selected to be the “designated server” according to the following criteria:

- The stratum (the distance in terms of NTP hops from the best authoritative time servers) is considered, and the server with the best (lowest) stratum is selected.
- If there is a tie in stratums, packets from servers defined on the device are preferred to Anycast packets, which in turn are preferred to Broadcast packets.
- If multiple servers pass the above criteria, then the server that sent the first (earliest) time packet is chosen.

If a better server is discovered later, it is selected to be the “designated server” at that time.

Polling

You can configure the system to acquire time information in the following ways:

- **Enable polling** — Time information is requested every polling interval.
- **Do not enable polling** — Time information is received when the system is brought up and every time that a topological change is made to the Running Configuration file, for example when an SNTP Unicast server is added.

This is configured by the user in the **SNTP Global Settings** page.

On power up, when the switch sends a request and there is no reply, it issues another request (three retries at most) after 20 seconds of waiting.

If no SNTP server is found, the process is invoked every “poll interval” (set in the **SNTP Global Settings** page), and a management trap is triggered.

Authentication

You can require that SNTP servers be authenticated, although this is not mandatory (see the **SNTP Authentication** pages).

MD5 (Message Digest 5) Authentication safeguards device synchronization paths to SNTP servers. MD5 is an algorithm that produces a 128-bit hash value. MD5 is a variation of MD4, and increases MD4 security.

MD5 both verifies the integrity of the communication and authenticates the origin of the communication.

Global Settings (Clock Source)

System time can be set manually, or it may be received from an external SNTP server. You if wish to set the system time manually, you do not to use the **Global Settings** page, because the default is manual (local) system time.

To set the clock source:

- 1 Click **System > Time Synchronization > Global Settings** in the tree view to display the **Global Settings** page.

Figure 9-5. Global Settings

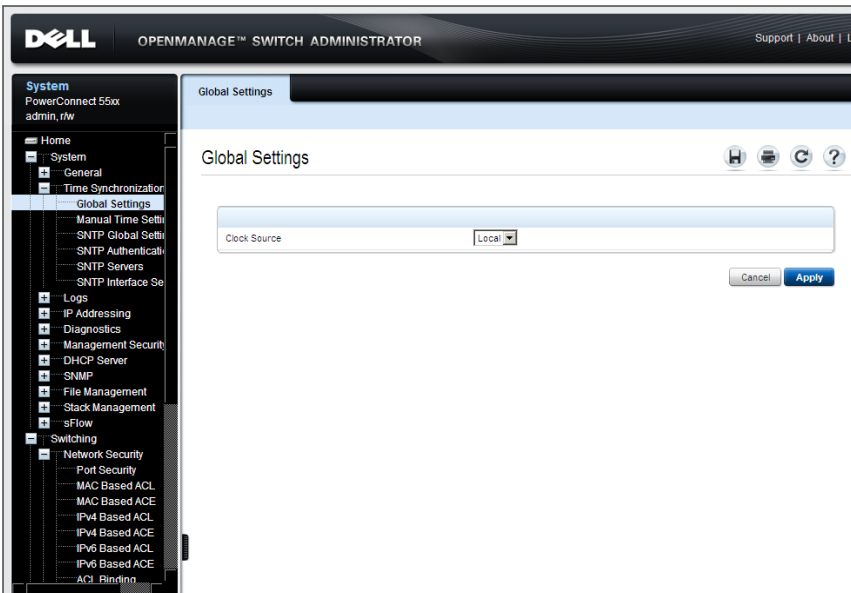

2 Select the **Clock Source**. The possible options are:

- **Local** —System time is taken from the device’s internal clock. Set this as defined in "Manual Time Settings" on page 162.
- **SNTP** — System time is set via an SNTP server. Set SNTP parameters as defined in "System Time from an SNTP Server" on page 170.

Defining the Clock Source Using CLI Commands

The following table summarizes the CLI commands for setting the clock source.

Table 9-7. Clock Source CLI Command

CLI	Description
<code>clock source {sntp}</code>	Configures an external time source for the system clock.
<code>no clock source</code>	Use the no form of this command to disable the external time source.
<code>show clock [detail]</code>	Displays the time and date from the system clock and its source.

The following is an example of the CLI commands:

```
console# configure
console(config)# clock source sntp
console# show clock detail
3:29:03 UTC Sep 7 2010
Time source is sntp
Time zone:
Offset is UTC+0
```

SNTP Global Settings

If **SNTP** was selected as the clock source in the **Global Settings** page, you must define the mechanism of setting time from an SNTP server. This is done in the SNTP pages, described below.

To define the types of server from which the device accepts SNTP information and the polling interval:

- 1 Click **System > Time Synchronization > SNTP Global Settings** in the tree view to display the **SNTP Global Settings** page.

Figure 9-6. SNTP Global Settings

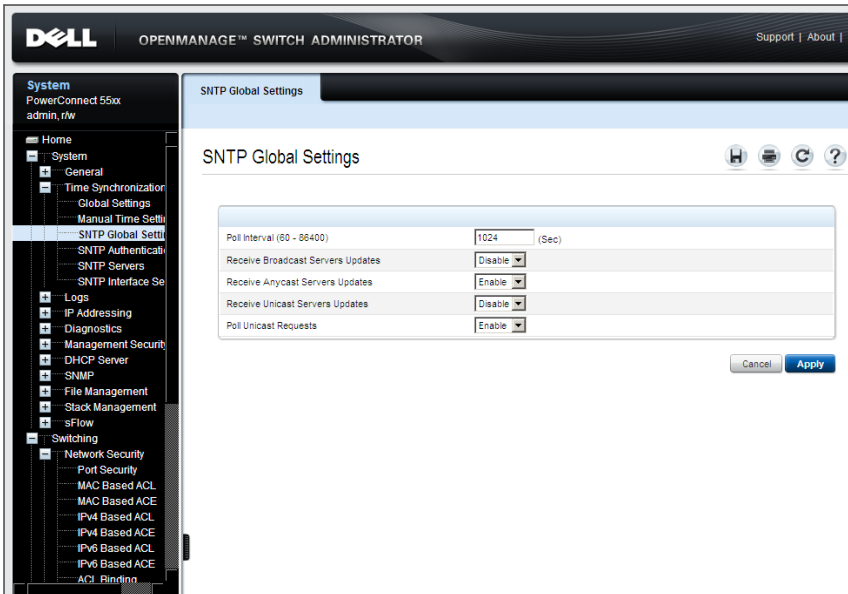

- 2 Enter the fields:
 - **Poll Interval (60-86400)** — Enter the interval (in seconds) at which the SNTP servers are polled.
 - **Receive Broadcast Servers Updates** — Enable/disable receiving time information from Broadcast servers.
 - **Receive Anycast Servers Updates** — Enable/disable receiving time information from Anycast SNTP servers.
 - **Receive Unicast Servers Updates** — Enable/disable receiving time information from the SNTP servers defined on the switch.
 - **Poll Unicast Requests** — Enable/disable sending SNTP Unicast server time information requests to the SNTP server.

Defining SNMP Global Settings Using CLI Commands

The following table summarizes the CLI commands for setting fields displayed in the SNMP Global Settings pages.

Table 9-8. SNMP Global Parameters CLI Commands

CLI Command	Description
sntp client poll timer <i>seconds</i>	Sets the polling time for an SNMP client.
no sntp client poll timer	Use the no form of this command to restore the default configuration.
sntp broadcast client enable	Enables SNMP Broadcast clients.
no sntp broadcast client enable	Use the no form of this command to disable SNMP Broadcast clients.
sntp anycast client enable	Enables SNMP Anycast clients.
no sntp anycast client enable	Use the no form of this command to disable SNMP Anycast clients.
sntp unicast client enable	Enables SNMP predefined Unicast clients.
no sntp unicast client enable	Use the no form of this command to disable SNMP Unicast clients.
show sntp configuration	Displays SNMP configuration

The following is an example of the CLI commands:

```
console(config)# sntp anycast client enable
```

SNTP Authentication

Use the **SNTP Authentication** page to enable/disable SNMP authentication between the device and an SNMP server, and to set the means by which the SNMP server is authenticated.

To configure SNTP authentication:

- 1 Click **System > Time Synchronization > SNTP Authentication** in the tree view to display the **SNTP Authentication: Summary** page.

Figure 9-7. SNTP Authentication: Summary

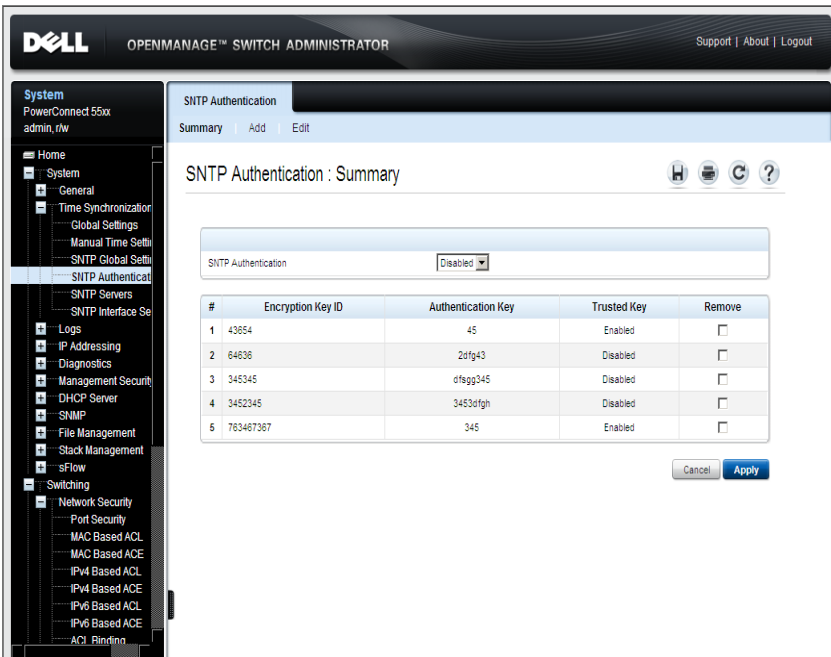

The previously-defined authentication keys are displayed.

- 2 **Enable/disable SNTP Authentication.** This enables/disables authenticating SNTP sessions between the device and an SNTP server.
- 3 Multiple keys can be defined. To add a new SNTP authentication key, click **Add**, and enter the fields.
 - **Encryption Key ID (1 - 4294967295)** — Enter the number used to identify this SNTP authentication key internally.
 - **Authentication Key (1 - 8 Characters)** — Enter the key used for authentication. The SNTP server must send this key for the switch to use its time/date information.

- **Trusted Key** — Check to specify that the encryption key is used to authenticate the (Unicast) SNTP server. If this is not checked, the key is not used for authentication (and another key(s) is used).

Defining SNTP Authentication Settings Using CLI Commands

The following table summarizes the CLI commands for setting fields displayed in the SNTP Authentication pages.

Table 9-9. SNTP Authentication CLI Commands

CLI Command	Description
sntp authenticate	Defines authentication for received SNTP traffic from servers.
no sntp authenticate	Use the no form of this command to disable the feature.
sntp trusted-key <i>key-number</i>	Authenticates the identity of a system to which SNTP will synchronize.
no sntp trusted-key <i>key-number</i>	Use the no form of this command to disable system identity authentication.
sntp authentication-key <i>key-number</i> md5 <i>value</i>	Defines an authentication key for SNTP.
no sntp authentication-key <i>key-number</i>	Use the no form of this command to remove the authentication key for SNTP.

The following is an example of the CLI commands:

```
console(config)# sntp authenticate
console(config)# sntp trusted-key 8
console(config)# sntp authentication-key 8 md5 Clkkey
```

SNTP Servers

To add an SNTP server or display SNTP server information:

- 1 Click **System > Time Synchronization > SNTP Servers** in the tree view to display the **SNTP Servers: Summary** page.

Figure 9-8. SNTP Servers: Summary

The screenshot shows the Dell OpenManage Switch Administrator interface. The left sidebar contains a navigation tree with 'System' expanded and 'SNTP Servers' selected. The main content area displays the 'SNTP Servers: Summary' page. At the top of the page, there are tabs for 'Summary', 'Add', and 'Edit'. Below the tabs, there are icons for home, print, refresh, and help. The main content is a table with the following data:

#	SNTP Server	Polling	Encryption Key ID	Preference	Status	Last Response	Offset	Delay	Remove
1	50.1.1.33	Enabled	345345	Secondary	Unknown	Mon, 1 Jan 1900 00:00:00	0	0	<input type="checkbox"/>
2	50.1.1.66	Enabled	763467367	Secondary	Unknown	Mon, 1 Jan 1900 00:00:00	0	0	<input type="checkbox"/>
3	50.1.1.100	Enabled	43854	Secondary	Unknown	Mon, 1 Jan 1900 00:00:00	0	0	<input type="checkbox"/>
4	84.2.36.200	Enabled	3452345	Secondary	Unknown	Mon, 1 Jan 1900 00:00:00	0	0	<input type="checkbox"/>

At the bottom of the table, there are 'Cancel' and 'Apply' buttons.

The following is displayed for the previously-defined servers:

- **SNTP Server** — IP address of server.
- **Polling** — Polls the selected SNTP server for system time information, when enabled.
- **Encryption Key ID** — Key Identification used to communicate between the SNTP server and device.

- **Preference** — SNTP server providing SNTP system time information. The system displays on of the following options:
 - **Primary** — The server from which time was last accepted.
 - **Secondary** — All other servers from which time was received.
- **Status** — The operating SNTP server status. The possible options are:
 - **Up** — The SNTP server is currently operating normally.
 - **Down** — An SNTP server is currently not available, for example, the SNTP server is currently not connected or is currently down.
 - **In progress** — The SNTP server is currently sending or receiving SNTP information.
 - **Unknown** — The progress of the SNTP information currently being sent is unknown, for example, the device is currently looking for an interface.
- **Last Response** — The last time a response was received from the SNTP server.
- **Offset** — The estimated offset of the server's clock, relative to the local clock, in milliseconds. The host determines the value of this offset, using the algorithm described in RFC 2030.
- **Delay** — The estimated round-trip delay of the server's clock, relative to the local clock over the network path between them, in milliseconds. The host determines the value of this delay, using the algorithm described in RFC 2030.

2 To add an SNTP Server, click **Add**, and enter the fields:

- **Supported IP Format** — Select whether IPv4 or IPv6 format is used for the IP address of the SNTP server.
- **IPv6 Address Type** — When the server supports IPv6, this specifies the type of static address supported. Select one of the possible options:
 - **Link Local** — A Link Local address that is non-routable and used for communication on the same network only.
 - **Global** — A globally unique IPv6 address; visible and reachable from different subnets.

- **Link Local Interface** — When the server supports an IPv6 Link Local address, this specifies the Link Local interface. Select one of the possible options:
 - **VLAN** — The VLAN on which the IPv6 interface is configured.
 - **ISATAP** — The IPv6 interface is configured on an ISATAP tunnel.
- **SNTP Server** — Enter the SNTP server’s IP address.
- **Poll Interval** — Enable/disable polling the selected SNTP server for system time information, when enabled.
- **Encryption Key ID** — Check to use an encryption key, and select one of the encryption keys that was defined in the **SNTP Authentication** pages.

Defining SNTP Servers Settings Using CLI Commands

The following table summarizes the CLI commands for setting fields displayed in the **SNTP Server** pages.

Table 9-10. SNTP Server CLI Commands

CLI Command	Description
sntp server { <i>ipv4-address</i> <i>ipv6-address</i> <i>ipv6-address</i> <i>hostname</i> } [poll] [key <i>key-id</i>]	Configures the device to use SNTP to request and accept SNTP traffic from a server. Use the no form of this command to remove a server from the list of SNTP servers.
no sntp server { <i>ipv4-address</i> <i>ipv6-address</i> <i>ipv6-address</i> <i>hostname</i> }	
sntp unicast client poll	Enables polling for the SNTP predefined Unicast clients.
no sntp unicast client poll	Use the no form of this command to disable the polling for the SNTP client.
show sntp status	Displays the SNTP server statuses.

The following is an example of the CLI commands:

```
console(config)# sntp server 100.1.1.1 poll key 10
console# show sntp status
Clock is unsynchronized
Unicast servers:
      Server      Status   Last Response   Offset   Delay
                  [mSec]   [mSec]
-----
Anycast server:
Server Interface  Status   Last Response   Offset   Delay
                  [mSec]   [mSec]
-----
Broadcast:
Interface         IP Address           Last Response
-----
gi1/0/1          00:00:00.0   Jan 1 2010
```

SNTP Interfaces

If receiving time information from Anycast servers is enabled, you can determine through which interface the Anycast packets are sent and received. If no interface is defined, Anycast requests are not sent.

To enable receiving Anycast updates on an interface:

- 1 Click **System > Time Synchronization > SNTP Interface Settings** to display the **SNTP Interface Settings: Summary** page.

Figure 9-9. SNTP Interface Settings: Summary

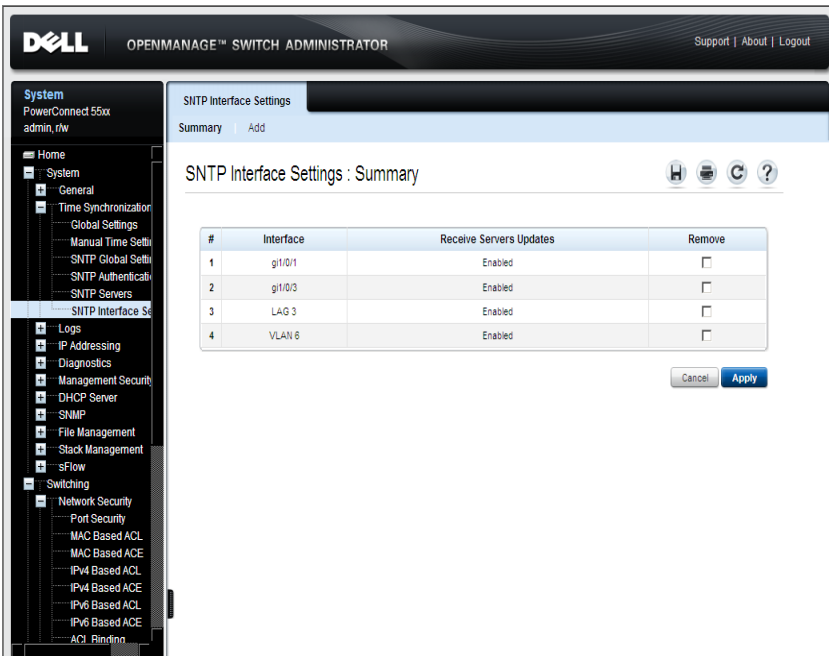

The following fields are displayed for every interface for which an SNTP interface has been enabled:

- **Interface** — The port, LAG or VLAN on which SNTP is enabled.
 - **Receive Servers Updates** — Displays whether the interface is enabled to receive updates from the SNTP server.
- 2 To add an interface that can receive SNTP server updates, click **Add**.
 - 3 Select an interface and enable/disable **State** to indicate that the interface can now receive/not receive SNTP server updates.

Defining SNTP Interface Settings Using CLI Commands

The following table summarizes the CLI commands for setting fields displayed in the SNTP Interface Settings pages.

Table 9-11. SNTP Interface Settings CLI Commands

CLI Command	Description
sntp client enable { [[gigabitethernet tengigabitethernet] port-id vlan vlan-id port-channel LAG-number] }	Enables the SNTP client on an interface in Global Configuration mode.
no sntp client enable { [[gigabitethernet tengigabitethernet] port-number vlan vlan-id port-channel LAG-number] }	Use the no form of this command to disable the SNTP client.
sntp client enable	Enables SNTP client on an interface in Interface Configuration mode.
no sntp client enable	Use the no form of this command to disable the SNTP client.
show sntp configuration	Shows the configuration of the Simple Network Time Protocol (SNTP).

The following is an example of the CLI commands:

```

console# configure
console(config)# sntp client enable gil/0/1
console# exit
console# configure
console(config)# interface gil/0/1
console(config-if)# sntp client enable
console# show sntp configuration
SNTP port : 123 .
Polling interval: 1024 seconds.
No MD5 authentication keys.
Authentication is not required for synchronization.
No trusted keys.
Unicast Clients: Disabled
Unicast Clients Polling: Disabled
Server          Polling   Encryption Key
-----
Broadcast Clients: disabled
Anycast Clients: disabled
Broadcast Interfaces: gil/0/1

```

CLI Script for Receiving Time from an SNTP Server

The following is a sample script that configures receiving system time from an SNTP server.

Table 9-12. Manual Time Setting CLI Commands

CLI	Description
console# configure	Set the source of time as an SNTP server.
console(config)# clock source sntp	

Table 9-12. Manual Time Setting CLI Commands (Continued)

CLI	Description
<code>console(config)#ntp client poll timer 6</code>	Set polling time to 6 seconds.
<code>console(config)#ntp unicast client enable</code>	Enable accepting time from predefined Unicast clients.
<code>console(config)#ntp unicast client poll</code>	Enable polling predefined Unicast clients.
<code>console(config)#ntp server 10.4.1.3 poll</code>	Define the server that will be used as an SNTP server.
<code>console(config)#exit</code>	Display SNTP settings.
<code>console# show ntp configuration</code>	
<code>console# show ntp status</code>	Display SNTP servers.

Logs

The Logs feature enables the switch to keep several, independent logs. Each log is a set of entries that record system events.

It contains the following topics:

- System Log Overview
- Global Parameters
- RAM Log
- Log File (in Flash)
- Login History
- Remote Log Server

System Log Overview

System logs record events and report errors or informational messages. Some aspects of system logging can be configured, as described below. When you configure system logging, the configuration applies to all units in the stack.

Some events are automatically logged, such as hardware problems. You may enable/disable logging the following types of events:

- **Authentication Events** in the **Global Parameters** page
- **Copy File Events** in the **Global Parameters** page
- **Management Access Events** in the **Global Parameters** page
- **Login History** in the **Login History** page

Event messages have a unique format, as per the System Logs (SYSLOG) protocol recommended message format for all error reporting, for example, SYSLOG and local device reporting messages are assigned a severity code, and include a message mnemonic that identifies the source application generating the message.

Messages may be filtered, based on their urgency or relevancy.

Events may be logged to the following destinations:

- **Console**
- **Logging buffer (RAM)**— Messages are stored in a cyclical file buffer. When the maximum number of messages is reached, messages are written starting at the beginning of the buffer (overwriting the old messages).

Logs stored on the Logging buffer are deleted when the device is reset.

- **Logging file (flash)** — Messages are stored in flash memory. When the buffer is full, messages are written starting at the beginning of the memory block (overwriting the old messages).
- **SYSLOG Server** — Messages are sent to a remote server. This is useful for central and remote management and to provide more space for storage of messages. Up-to eight SYSLOG servers can be defined in the **Remote Log Server Settings** pages.

You can select where to send logging messages according to their severity. Each of the severity level can be directed to the console, RAM log, flash log file or SYSLOG server or to any combination of these destinations.

Global Parameters

Use the **Global Parameters** page to enable/disable logging for the following logging severity levels.

- **Emergency** — If the device is down or not functioning properly, an emergency log message is saved to the specified logging location.
- **Alert** — An alert log is saved if there is a serious device malfunction, for example, all device features are down.
- **Critical** — A critical log is saved if a critical device malfunction occurs, for example, two device ports are not functioning, while the rest of the device ports remain functional.
- **Error** — A device error has occurred, for example, a single port is offline.
- **Warning** — The lowest level of a device warning. The device is functioning, but an operational problem has occurred.
- **Notice** — Provides device information to which you might have to respond.
- **Informational** — Provides device information to which you do not have to respond.
- **Debug** — Provides debugging messages.

If you enable logging, some events are automatically logged, and in addition, you can enable/disable specific types of logging and set their destination.

To configure logging:

- 1 Click **System > Logs > Global Parameters** in the tree view to display the **Global Parameters** page.

Figure 9-10. Global Parameters

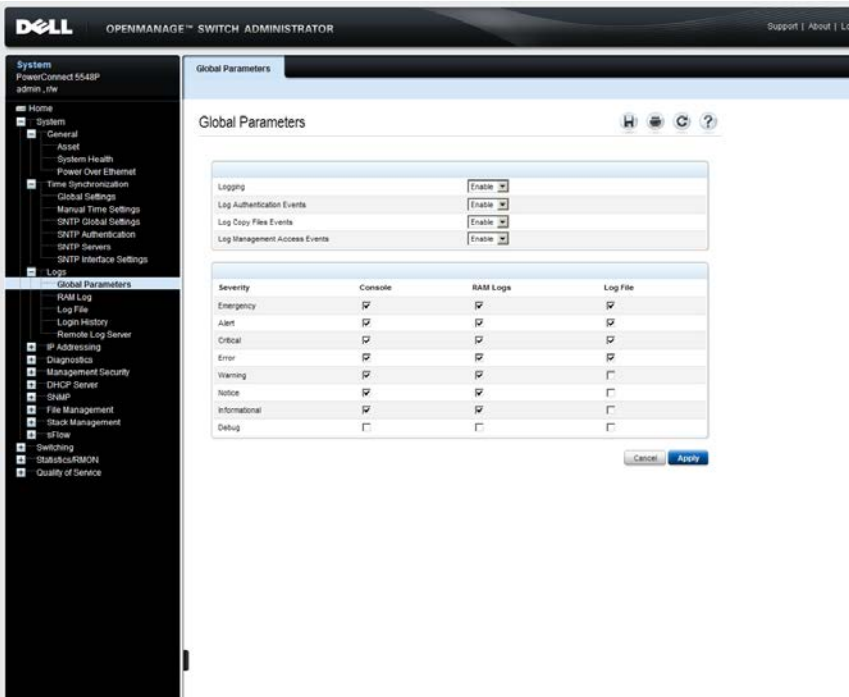

- 2 Enable/disable logging in the **Logging** drop-down list. Console logs are enabled by default, and cannot be disabled.
- 3 If Logging is enabled, select the types of events to be logged in addition to the events that are always logged:
 - **Log Authentication Events** — Enable/disable generating logs when users are authenticated.

- **Log Copy Files Events** — Enable/disable generating logs when files are copied.
 - **Log Management Access Events** — Enable/disable generating logs when the device is accessed using a management method, for example, each time the device is accessed using SSH, a device log is generated.
- 4** To select the destination of logging messages, according to their severity levels, check the minimum severity level that will be associated with the console log, RAM log, Log file (Flash memory) and remote SYSLOG servers. When a severity level is selected, all severity levels above the selection are selected automatically.

Enabling Logs Using CLI Commands

The following table summarizes the CLI commands for setting fields displayed in the **Global Parameters** page.

Table 9-13. Global Log Parameters CLI Commands

CLI Command	Description
logging on	Enables error message logging.
no logging	Turns off error message logging.
logging console <i>level</i>	Limits messages logged to the console, based on severity.
no logging console <i>level</i>	Use the no form of this command to disable logging limiting to the console.
logging file <i>level</i>	Limits SYSLOG messages stored in flash memory, based on severity.
no logging file	Use the no form of this command to cancel using the buffer.
file-system logging {<i>copy</i> <i>delete-rename</i>}	Enables the logging of file system events.

Table 9-13. Global Log Parameters CLI Commands (Continued)

CLI Command	Description
management logging {deny}	Enables Management Access List (ACL) deny events.
no management logging {deny}	Use the no form of this command to disable logging management access list events.
aaa logging {login}	Enables logging authentication login events.
no aaa logging {login}	Use the no form of this command to disable logging authentication login events.

The following is an example of the CLI commands:

```
console# configure
console(config)# logging on
console(config)# logging console errors
console(config)# logging file alerts
```

RAM Log

To manage the RAM log buffer:

- 1 Click **System > Logs > RAM Log** in the tree view to display the RAM Log page.

Figure 9-11. RAM Log

The screenshot shows the Dell OpenManage Switch Administrator interface. The left sidebar contains a navigation tree with the following items: System (PowerConnect 5549P, admin, /fw), Home, System (General, Asset, System Health, Power Over Ethernet, Time Synchronization, Global Settings, Manual Time Settings, SNTP Global Settings, SNTP Authentication, SNTP Servers, SNTP Interface Settings), Logs (Global Parameters, RAM Log, Log File, Log History, Remote Log Server), IP Addressing, Diagnostics, Management Security (DHCP Server, SNMP), File Management, Stack Management (iFlow), Switching, Statistics/ROMON, and Quality of Service.

The main content area is titled "RAM Log" and contains a configuration table and a log entry table.

Attribute		Current Setting	New Setting (after reset)
Max RAM Log Entries (20-400):		200	<input type="text" value="200"/>

#	Log Index	Log Time	Severity	Description
1	2147483531	02-Oct-2008 15:45:20	Info	%AAAA-LOGCONNECT: http connection for user admin, source 10.5.229.9 destination 10.5.229.84 TERMINATED
2	2147483532	02-Oct-2008 15:45:14	Info	%AAAA-LOGCONNECT: New http connection for user admin, source 10.5.229.9 destination 10.5.229.84 ACCEPTED
3	2147483533	02-Oct-2008 15:14:42	Info	%AAAA-LOGCONNECT: New http connection for user admin, source 10.5.229.9 destination 10.5.229.84 ACCEPTED
4	2147483534	02-Oct-2008 15:05:31	Error	%HTTP_HTTPS-E-CHANGINGSTCS: ERROR - in obj_vQueryEntryDel- tag, can not convert the strB value to string value (hex=0x
5	2147483535	02-Oct-2008 12:47:20	Warning	%LRK-W-Down: P032
6	2147483536	02-Oct-2008 12:41:07	Info	%AAAA-LOGCONNECT: http connection for user admin, source 10.5.229.9 destination 10.5.229.84 TERMINATED
7	2147483537	02-Oct-2008 12:35:42	Info	%AAAA-LOGCONNECT: New http connection for user admin, source 10.5.229.9 destination 10.5.229.84 ACCEPTED
8	2147483538	01-Oct-2008 18:48:05	Info	%AAAA-LOGCONNECT: New http connection for user admin, source 10.5.224.192 destination 10.5.229.84 ACCEPTED
9	2147483539	01-Oct-2008 18:48:54	Info	%MT-Startup: Warm Startup
10	2147483540	01-Oct-2008 18:45:39	Notice	%SYSLOG-N-LOGGING: Logging started.
11	2147483541	01-Oct-2008 18:45:28	Notice	%STCK SYSL-A-UNITMSG: UNIT 0 3.0mg %Environment-A-FAN-STAT-CHG: FAN# 2 status changed - not operational.
12	2147483542	01-Oct-2008 18:45:28	Alert	%STCK SYSL-A-UNITMSG: UNIT 0 3.0mg %Environment-A-FAN-STAT-CHG: FAN# 1 status changed - not operational.
13	2147483543	01-Oct-2008 18:45:28	Alert	%STCK SYSL-A-UNITMSG: UNIT 0 3.0mg %Environment-A-FAN-STAT-CHG: FAN# 1 status changed - not operational.
14	2147483544	01-Oct-2008 18:44:52	Warning	%LRK-W-Down: m3G0
15	2147483545	01-Oct-2008 18:44:51	Warning	%LRK-W-Down: m3G1
16	2147483546	01-Oct-2008 18:44:51	Warning	%LRK-W-Down: g3/G04
17	2147483547	01-Oct-2008 18:44:51	Warning	%LRK-W-Down: g3/G03
18	2147483548	01-Oct-2008 18:44:51	Warning	%LRK-W-Down: g3/G02
19	2147483549	01-Oct-2008 18:44:51	Warning	%LRK-W-Down: g3/G01
20	2147483550	01-Oct-2008 18:44:51	Warning	%LRK-W-Down: g3/G00
21	2147483551	01-Oct-2008 18:44:51	Warning	%LRK-W-Down: g3/G19
22	2147483552	01-Oct-2008 18:44:50	Warning	%LRK-W-Down: g3/G18
23	2147483553	01-Oct-2008 18:44:50	Warning	%LRK-W-Down: g3/G17
24	2147483554	01-Oct-2008 18:44:50	Warning	%LRK-W-Down: g3/G16
25	2147483555	01-Oct-2008 18:44:50	Warning	%LRK-W-Down: g3/G15
26	2147483556	01-Oct-2008 18:44:50	Warning	%LRK-W-Down: g3/G14

The **Max RAM Log Entries (20-400)** line, which contains the maximum number of RAM log entries permitted, is displayed. When the log buffer is full, the oldest entries are overwritten. The **Current Setting** contains how many entries are currently permitted, and you can change this number in the **New Setting (after reset)** field.

The following is displayed for the existing logs:

- **Log Index** — The log number in the RAM Log table.

- **Log Time** — The time at which the log was entered into the RAM Log table.
- **Severity** — The log severity.
- **Description** — The log entry text.

2 To remove all entries from the RAM log, click **Clear Log**.

Viewing and Clearing the RAM Log Table Using the CLI Commands

The following table summarizes the CLI commands for setting the size of the RAM log buffer, viewing, and clearing entries in the RAM log.

Table 9-14. RAM Log Table CLI Commands

CLI Command	Description
logging buffered <i>size</i>	Sets the number of SYSLOG messages stored in the internal buffer (RAM).
no logging buffered	Use the no form of this command to cancel using the buffer.
show logging	Displays the RAM logging buffer.
clear logging	Clears the RAM logging buffer.

The following is an example of the CLI commands:

```
console(config)# logging buffered 300
04-Oct-2010 09:47:04 %SYSLOG-N-LOGGINGBFRSIZE: the number
of syslog messages stored in the internal buffer will be
changed to 300 (after reboot).
```

Log File (in Flash)

To view and/or clear the flash memory log file:

- 1 Click **System > Logs > Log File** in the tree view to display the **Log File** page.

Figure 9-12. Log File

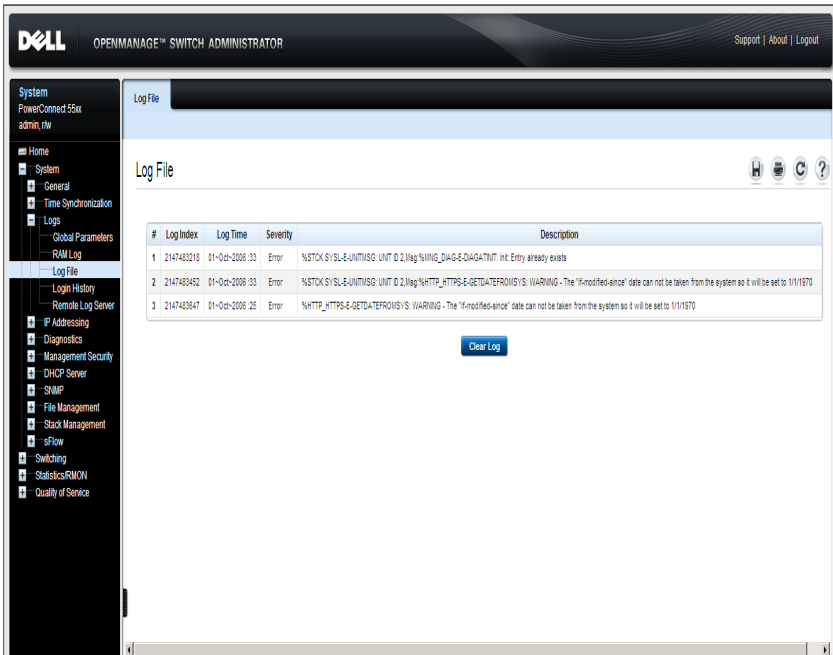

The following is displayed for the existing logs:

- **Log Index** — The log number in the Log file.
- **Log Time** — The time at which the log was entered.
- **Severity** — The log severity.
- **Description** — The log entry text.

- 2 To remove all entries from the log file, click **Clear Log**.

Displaying the Log File Table Using the CLI Commands

The following table summarizes the CLI commands for setting fields displayed in the **Log File** page.

Table 9-15. Log File Table CLI Commands

CLI Command	Description
show logging file	Displays the logging state and the SYSLOG messages stored in the logging file.

The following is an example of the CLI commands:

```
console# show logging file
Logging is enabled.
Console Logging: Level info. Console Messages: 0 Dropped.
Buffer Logging: Level info. Buffer Messages: 62 Logged, 62
Displayed, 200 Max.
File Logging: Level debug. File Messages: 11 Logged, 51
Dropped.
SysLog server 1.1.1.1 Logging: info. Messages: 0 Dropped.
01-Jan-2000 01:12:01 :%COPY-W-TRAP: The copy operation was
completed successfully
01-Oct-2010 01:11:49 :%LINK-I-Up: gi/1/0/11
01-Oct-2010 01:11:46 :%LINK-I-Up: gi/1/0/12
```

Login History

Use the **Login History** page to monitor users, including the time a user logged in, and the protocol used to log on to the device.

To enable user history logging and view user login history:

- 1 Click **System > Logs > Login History** in the tree view to display the **Login History** page.

Figure 9-13. Login History

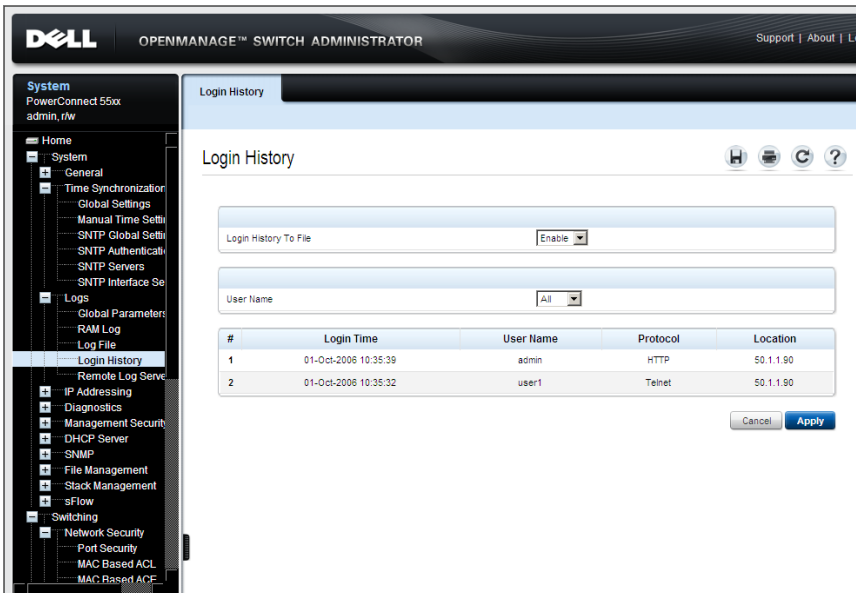

The login history for the selected user or all users is displayed.

- 2 Enable/disable **Login History to File** to record login history.
- 3 Select a user or **All** from the **User Name** drop-down list. The login history for this user is displayed in the following fields:
 - **Login Time** — The time the selected user logged on to the device.
 - **User Name** — The user that logged on to the device.
 - **Protocol** — The means by which the user logged on to the device.
 - **Location** — The IP address of the station from which the device was accessed.

Displaying the Device Login History Using CLI Commands

The following table summarizes the CLI commands for viewing and setting fields displayed in the **Login History** page.

Table 9-16. Login History CLI Commands

CLI Command	Description
aaa login-history file	Enables writing to the login history file.
no aaa login-history file	Use the no form of this command to disable writing to the login history file.
show users login-history [<i>username</i>]	Displays the user's login history.

The following is an example of the CLI commands:

```
console (config)# aaa login-history file
console# show users login-history
```

Login Time	Username	Protocol	Location
-----	-----	-----	-----
01-Oct-2010 23:58:17	admin	HTTP	172.16.1.8
01-Oct-2010 07:59:23	admin	Telnet	172.16.0.8

Remote Log Server

Log messages can be sent to remote log servers, using the SYSLOG protocol.

To add a remote log server:

- 1 Click **System > Logs > Remote Server Settings** in the tree view to display the **Remote Log Server: Summary** page.

Figure 9-14. Remote Log Server: Summary

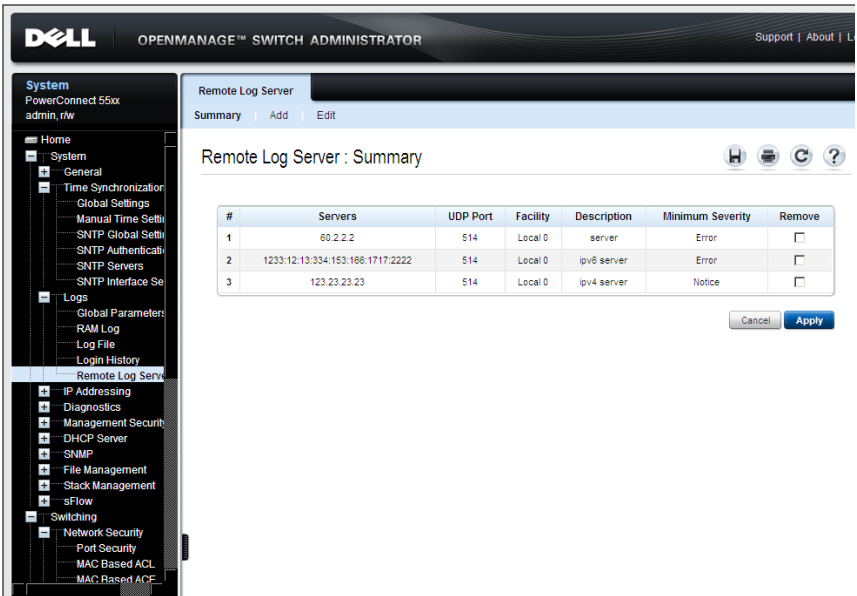

The previously-defined remote servers are displayed.

- 2 To add a remote log server, click **Add**, and enter the fields:
 - **Supported IP Format** — Select whether the IPv4 or IPv6 format is supported.
 - **IPv6 Address Type** — When the server supports IPv6, this specifies the type of static address supported. The possible options are:
 - **Link Local** — A Link Local address that is non-routable and used for communication on the same network only.

- **Global** — A globally unique IPv6 address; visible and reachable from different subnets.
- **Link Local Interface** — When the server supports an IPv6 Link Local address, this specifies the Link Local interface. The possible options are:
 - **VLAN** — The VLAN on which the IPv6 interface is configured.
 - **ISATAP** — The IPv6 interface is configured on an ISATAP tunnel.
- **New Log Server IP Address** — Enter the IP address of the remote SYSLOG server.
- **UDP Port (1-65535)** — Enter the UDP port to which the logs are sent for the selected server.
- **Facility** — Select a user-defined application from which system logs are sent to the remote server. Only a single facility can be assigned to a single server. If a second facility level is assigned, the first facility level is overridden. All applications defined for a device utilize the same facility on a server.
- **Description (0-64 Characters)** — Enter a server description.
- **Severity to Include** — Check the severity levels to be logged to the remote server. The event severity levels are listed on this page in descending order from the highest severity to the lowest. When a severity level is selected to appear in a log, all higher severity events are automatically selected to appear in the log. When a security level is not selected, no lower severity events appear in the log.

Working with Remote Server Logs Using the CLI Commands

The following table summarizes the CLI command for working with remote log servers.

Table 9-17. Remote Log Server CLI Commands

CLI Command	Description
logging host { <i>ipv4-address</i> <i>ipv6-address/hostname</i> } [port <i>port-id</i>] [severity level] [facility facility] [description text]	Logs messages to a remote server with this IP address.
no logging host { <i>ipv4-address</i> <i>ipv6-address/hostname</i> }	Use the no form of this command to delete the SYSLOG server with the specified address from the list of SYSLOGs.
show syslog-servers	Displays list of SYSLOG servers.

The following is an example of the CLI commands:

```
console (configure) # logging host 1.1.1.1
console# show syslog-servers
Device Configuration
-----
IP Address  Port  Facility  Severity  Description
-----
1.1.1.1     514   local7    info
1.1.1.2     514   local7    info
1.1.1.3     514   local7    info
1.1.1.4     514   local7    info
```

IP Addressing

This section describes how to configure IP addresses on the switch, and contains the following topics:

- IP Addressing Overview
- IPv4 Interface Parameters
- DHCP IPv4 Interface
- IPv4 Static Routing
- IPv6 Interfaces
- IPv6 Default Gateway
- ISATAP Tunnel
- IPv6 Neighbors
- IPv6 Routes Table
- Domain Name System
- Default Domain Names
- Host Name Mapping
- ARP
- UDP Relay

IP Addressing Overview

The device functions as an IPv6-compliant host, as well as an IPv4-host (also known as dual stack). This enables device operation in a pure-IPv6 network, as well as in a combined IPv4/IPv6 network.

Difference Between IPv4 and IPv6 Addressing

The primary difference between IPv4 to IPv6 is the length of network addresses. IPv6 addresses are 128 bits, whereas IPv4 addresses are 32 bits. Thus, IPv6 addresses enable the use of many more unique addresses.

The 128-bit IPv6 address format is divided into eight groups of four hexadecimal digits. Abbreviation of this format by replacing a group of zeros with double colons (::) is acceptable. IPv6 address representation can be further simplified by suppressing the leading zeros.

All IPv6 address formats are acceptable, yet for display purposes, the system displays the most abbreviated form, which replaces groups of zeros with double colons and removes the leading zeros.

IPv6 Prefixes

While Unicast IPv6 addresses written with their prefix lengths are permitted, in practice their prefix lengths are always 64 bits, and therefore are not required to be expressed. Any prefix that is less than 64 bits is a route or address range that summarizes a portion of the IPv6 address space.

For every assignment of an IP address to an interface, the system runs the Duplicate Address Detection (DAD) algorithm to ensure uniqueness.

An intermediary transition mechanism is required for IPv6-only nodes to communicate with IPv6 nodes over an IPv4 infrastructure. The tunneling mechanism implemented is the Intra-Site Automatic Tunnel Addressing Protocol (ISATAP). This protocol treats the IPv4 network as a virtual IPv6 local-link, with each IPv4 address mapped to a Link Local IPv6 address.

IPv4 Interface Parameters

You can assign IP addresses to the interface in the following ways:

- Manual Assignment — Described below
- DHCP Server Assignment — Described in "DHCP IPv4 Interface" on page 207

Multiple IP addresses can be configured in the **IPv4 Interface Parameters** pages. These IP addresses can be assigned to a port, LAG, or VLAN interface.

When an IP address is assigned, it is checked for uniqueness in the following way:

- A gratuitous ARP request is sent three times every three seconds.
- If after $(3+1)*3 = 12$ seconds the switch has not received the ARP response, the IP address is considered to be unique.
- During the procedure the switch has to reply to gratuitous ARP and probe ARP requests with the validated IP address.

The IP address is assigned even if the above validation procedure concludes that the IP address in question is not unique, but a SYSLOG message is generated.

In addition to the above validation procedure every time a switch receives an ARP request with a sender IP address that is equal to its IP address defined on the input interface it sends a SYSLOG message informing of IP duplication, containing the sender IP and MAC addresses, from the received ARP message.

To assign an IP address to an interface, and to define subnets to which traffic can be routed:

- 1 Click **System > IP Addressing > IPv4 Interface Parameters** in the tree view to display the **IP Interface Parameters: Summary** page.

Figure 9-15. IPv4 Interface Parameters: Summary

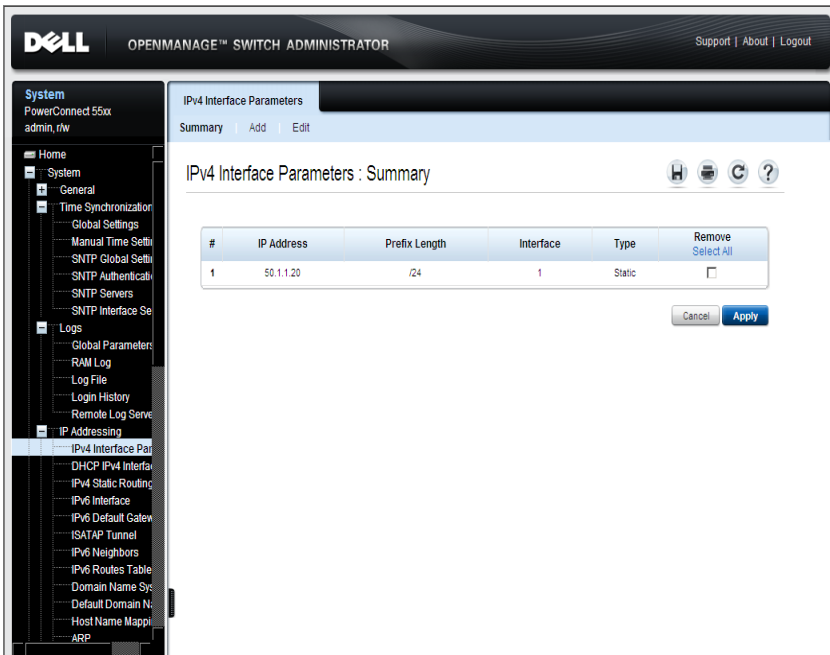

The previously-assigned IP addresses are displayed.

- 2 To add an IP address to an interface, click **Add**, and enter the fields:
 - **IP Address** — Enter the IP address assigned to the interface.
 - **Network Mask** — Select the subnetwork mask to which traffic can be routed.
 - **Prefix Length** — Enter the number of bits that comprise the IP address prefix of the subnetwork.
 - **Interface** — Select the interface for which the IP address is defined. Select an interface type **Port**, **LAG**, or **VLAN** and the specific interface number.

Defining IPv4 Interfaces Using CLI Commands

The following table summarizes the CLI commands for setting fields displayed in the **IPv4 Interfaces Parameters** page.

Table 9-18. IPv4 Interface Parameters CLI Commands

CLI Command	Description
ip address <i>ip-address</i> { <i>mask</i> <i>prefix-length</i> }	Sets an IP address.
no ip address [<i>ip-address</i>]	Use the no form of the command to remove an IP address.
show ip interface [[<i>gigabitethernet</i> <i>tengigabitethernet</i>] <i>port-number</i> <i>vlan</i> <i>vlan-id</i> <i>port-channel</i> <i>LAG-number</i>]	Displays the usability status of interfaces configured for IP.

The following are sample procedures to configure a static IPv4 address on an interface using CLI and then to remove it:

Table 9-19. Sample CLI Script to Configure IPv4 Statically on a VLAN

CLI Command	Description
console# config	Enter Global Configuration mode.
console(config)# interface vlan 1	Enter Interface mode for VLAN 1.
console(config-if)# ip address 10.5.225.40 /27	Set the routing interface with prefix length of 27.
console(config-if)# ip default-gateway 10.5.225.33	Set the address of the default gateway
console(config-if)# no ip address	Remove the address (if required).

Table 9-20. Sample CLI Script to Configure IPv4 Statically on a Port

CLI Command	Description
console# config	Enter Global Configuration mode.
console(config)# interface gi1/0/1	Enter Interface mode for port 1 on unit 1.
console(config)# no switchport	Enable the port to work as an IP interface (Layer 3 mode).
console(config-if)# ip address 10.5.225.40 /27	Configure an IP address with prefix length of 27.
console(config-if)# ip default-gateway 10.5.225.33	Set the address of the default gateway
console(config-if)# no ip address	Remove the address (if required).

DHCP IPv4 Interface

The switch can operate in the following ways:

- It can function as a DHCP client that obtains its own IP from a DHCP server, as described in this section
- It can function as a DHCP server that allocates IP addresses to other devices, as described in "DHCP Server" on page 290

When the interface is configured as a DHCP client, it keeps requesting an IP address from the DHCP server, until it receives one. It then sends Address Resolution Protocol (ARP) packets to confirm the uniqueness of the IP address. If the ARP response shows that the IP address is in use, the switch sends a DHCPDECLINE message to the DHCP server, and sends another DHCPDISCOVER packet that restarts the process.

IP address collisions occur when the same IP address is used in the same IP subnet by more than one device. Address collisions require administrative actions on the DHCP server and/or the devices that collide.

Up to 32 interfaces (ports, LAGs, and/or VLAN) on the switch can be configured with a static or dynamic IP address. The IP subnets to which these IP addresses belong are known as directly connected/attached IP subnets.

The IP address assignment rules for the switch are as follows:

- If the IP address on the switch is changed, the switch issues gratuitous ARP packets to the corresponding VLAN, to check IP address collisions.
- When a client must renew its lease, prior to its expiration date, a DHCPREQUEST message is sent.
- A specific interface can have either a static IP address or a dynamic IP address, but not both.

To define the switch as a DHCP client:

- 1 Click **System > IP Addressing > DHCP IPv4 Interface** in the tree view to display the **DHCP IPv4 Interface: Summary** page.

Figure 9-16. DHCP IPv4 Interface: Summary

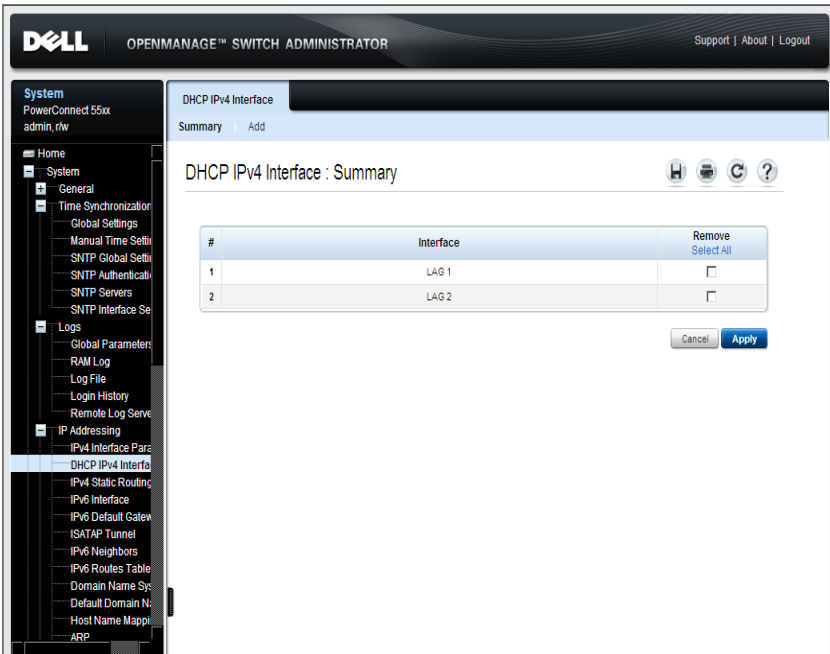

The previously-configured DHCP IPv4 interfaces are displayed.

- 2 To add an interface that can receive an IP address, click **Add** and select the whether the interface is a port, LAG or VLAN in the **Interface** field.

Defining DHCP IPv4 Interfaces Using CLI Commands

The following table summarizes the CLI commands for setting fields in the **DHCP IPv4 Interface** pages.

Table 9-21. DHCP IPv4 Interface CLI Commands

CLI Command	Description
<code>ip address dhcp</code>	Acquires an IP address on an Ethernet interface from the Dynamic Host Configuration Protocol (DHCP).
<code>no ip address dhcp</code>	Use the no form of this command to release an acquired IP address.

Configuring DHCP IPv4 Interfaces Using CLI

The following is a sample CLI script to configure a dynamic IPv4 address on an interface and then to remove it:

Table 9-22. Sample CLI Script to Configure IPv4 Dynamically on a VLAN

CLI Command	Description
console# config	Enter Global Configuration mode.
console(config)# interface vlan 1	Enter VLAN mode for VLAN 1.
console(config)# no switchport	Enable the port to work as an IP interface (Layer 3 mode).
console(config-if)# ip address dhcp	Use the DHCP protocol to acquire the IP address.
console(config-if)# no ip address dhcp	Remove the address (if required).

Table 9-23. Sample CLI Script to Configure IPv4 Dynamically on a Port

CLI Command	Description
console# config	Enter Global Configuration mode.
console(config)# interface vlan 1	Enter VLAN mode for VLAN 1.
console(config-if)# ip address dhcp	Use the DHCP protocol to acquire the IP address.
console(config-if)# no switchport	Enable the port to work as an IP interface (Layer 3 mode).
console(config-if)# no ip address dhcp	Remove the address (if required).

IPv4 Static Routing

IPv4 static routes can be configured for IP addresses that are not on directly connected networks. These are defined in the **IPv4 Static Routing** pages.

When routing traffic, the next hop is determined according to the longest prefix match (LPM algorithm). A destination IPv4 address may match multiple routes in the IPv4 Static Route table. The switch uses the matched route with the longest prefix match.

To add an IPv4 static route:

- 1 Click **System > IP Addressing > IPv4 Static Routing** in the tree view to display the **IPv4 Static Routing: Summary** page.

Figure 9-17. IPv4 Static Routing: Summary

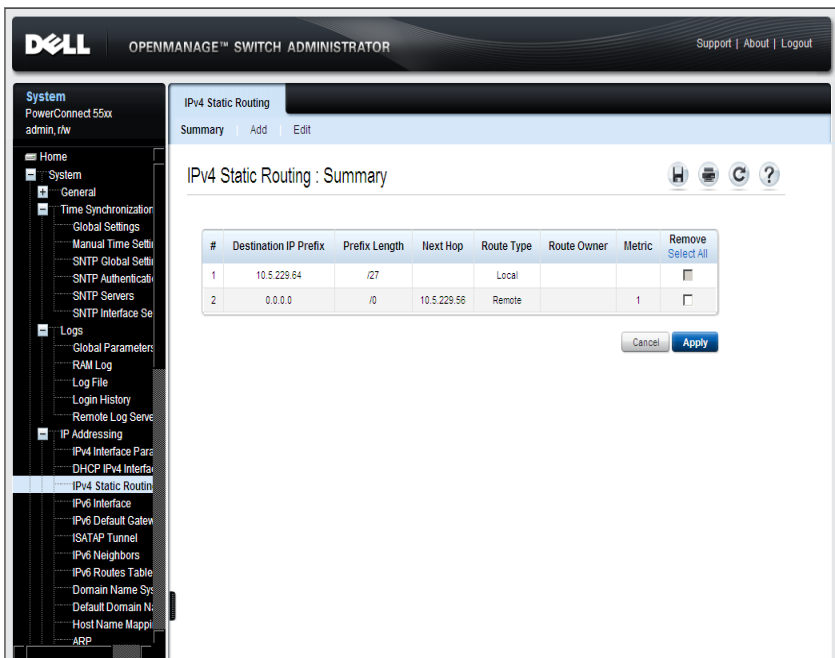

- 2 Click **Add** to add a destination, and enter the fields:
 - **Destination IP Prefix** — Enter the destination IPv4 prefix. If all zeros are entered, this represents a default route.
 - **Network Mask** — Select the destination IPv4 mask.
 - **Prefix Length** — Select the length of the destination IPv4 address prefix.

- **Next Hop** — Enter the IP address to which the packet is forwarded on the route to the destination address. This is typically the address of a neighboring switch.
- **Route Type** — Select the route type. The possible options are:
 - **Reject** — Rejects the route and stops routing to the destination network via all gateways. This ensures that if a frame arrives with the destination IP of this route, it is dropped.
 - **Remote** — The route is a remote path.
- **Metric (1-255)** — Enter the administrative distance (cost) to the destination.

Defining IPv4 Static Routing Using CLI Commands

The following table summarizes the CLI commands for configuring IPv4 static routing.

Table 9-24. IPv4 Static Routing CLI Commands

CLI Command	Description
<code>ip routing</code>	Enables IPv4 Routing.
<code>no ip routing</code>	Use the no format of the command to disable IPv4 Routing.
<code>ip route <i>prefix</i> {<i>mask</i> <i>prefix-length</i>} <i>ip-address-next-hop</i> [<i>metric distance</i>] [<i>reject-route</i>]</code>	Configures static routes. Use the no form of this command to remove static routes.
<code>no ip route <i>prefix</i> {<i>mask</i> <i>prefix-length</i>} [<i>ip-address-next-hop</i>]</code>	
<code>show ip route</code>	Displays the current routing table state.

The following is an example of the CLI command:

```
console(config)# ip route prefix 192.168.1.1 /8
10.5.234.255 metric 3 reject-route
```

Configuring Two IP Networks on Two Different VLANs Using CLI

The following shows how to configure two IP networks on two different VLANs using CLI:

Table 9-25. Sample CLI Script to Configure Two IP Networks on Two Different VLANs

CLI Command	Description
console# config	Enter Global Configuration mode.
console(config)# vlan database	Enter VLAN mode.
console(config-vlan)# vlan 100-150	Create VLANs number 100 to 150.
console(config-vlan)# exit	Exit VLAN mode.
console(config)# interface gil1/0/1	Enter Interface mode for port 1 on unit 1.
console(config-if)# switchport access vlan 100	Make port a member of VLAN 100.
console(config-if)# ip address 1.1.1.1 255.255.255.0	Set the IP address with mask.
console(config-vlan)# exit	Exit Interface mode for port.
console(config)# interface gil1/0/2	Enter Interface mode for port 2 on unit 1.
console(config-if)# switchport access vlan 150	Make port a member of VLAN 150.
console(config-if)# ip address 2.1.1.1 255.255.255.0	Set the IP address with mask.
console(config-vlan)# exit	Exit Interface mode for port.

To test this setup described in Figure 11-18:

- 1 Connect a host whose address is 1.1.1.2 to interface 1/0/1 (default route 1.1.1.1)
- 2 Connect a host whose address 2.1.1.2 to port 1/0/2 (default route 2.1.1.1)
- 3 Ping from 1.1.1.2 to 2.1.1.2 to verify the configuration

Figure 9-18. IP Routing Setup

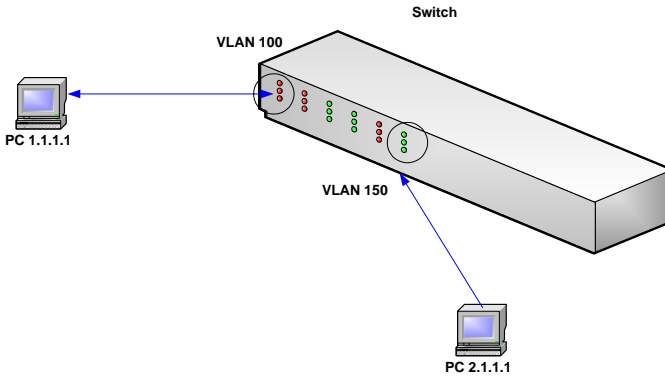

IPv6 Interfaces

The system supports IPv6-addressable hosts.

To define IPv6 interfaces:

- 1 Click **System > IP Addressing > IPv6 Interface** in the tree view to open the **IPv6 Interface: Summary** page.

Figure 9-19. IPv6 Interface: Summary

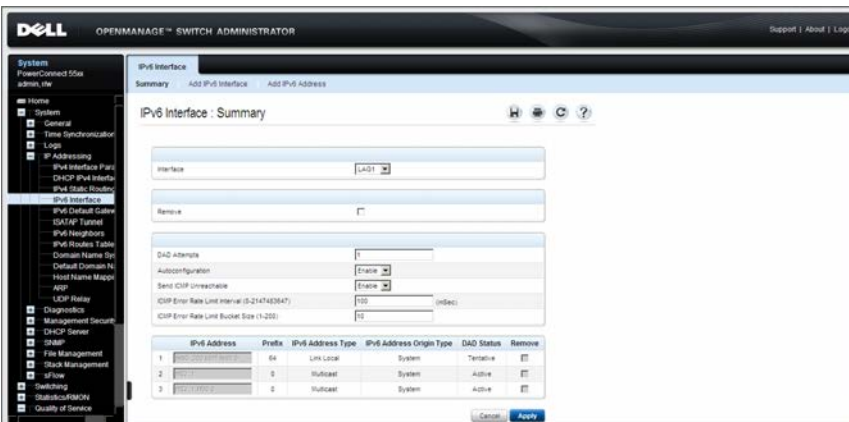

- 2 Select an interface. The IPv6 addresses defined on the interface are displayed. In addition to the fields described in the **Add** pages, the following fields are displayed:
 - **ICMP Error Rate Limit Interval (0-2147483647)** — Enter the rate-limit interval for ICMPv6 error messages in milliseconds. The value of this parameter together with the Bucket Size parameter (below) determines how many ICMP error messages may be sent per time interval, for example, a rate-limit interval of 100 ms and a bucket size of 10 messages translates to 100 ICMP error messages per second.
 - **ICMP Error Rate Limit Bucket Size (1-200)** — Enter the bucket size for ICMPv6 error messages. The value of this parameter together with the **ICMP Error Rate Limit Interval** parameter determines how many ICMP error messages may be sent per time interval, for example, a rate-limit interval of 100 ms and a bucket size of 10 messages translates to 100 ICMP error messages per second.
- 3 To add a new IPv6 interface, click **Add IPv6 Interface**, and enter the fields:
 - **Interface** — Select an IPv6 interface to be configured.
 - **Number of DAD Attempts** — Enter the number of consecutive neighbor solicitation messages that are sent on an interface while Duplicate Address Detection (DAD) is performed on Unicast IPv6 addresses on this interface. New addresses remain in a tentative state while duplicate address detection is performed. A field value of 0, disables duplicate address detection processing on the specified interface. A field value of 1, indicates a single transmission without follow up transmissions.
 - **Autoconfiguration** — Enable/disable stateless auto configuration of IPv6 address assignment. When enabled, the router solicitation ND procedure is initiated. This discovers a router in order to assign an IP address to the interface, based on prefixes received with RA messages. When auto configuration is disabled, no automatic assignment of IPv6 global Unicast addresses is performed, and existing, automatically-assigned IPv6 global Unicast addresses are removed from the interface.

- **Send ICMP Unreachable** — Enable/disable transmission of ICMPv6 address Unreachable messages. When enabled, unreachable messages are generated for any packet arriving on the interface with unassigned TCP/UDP port.
- 4** To add an address to an IPv6 interface, click **Add IPv6 Address**, and enter the fields for the selected interface:
- **IPv6 Address Type** — Check the means by which the IP address was added to the interface. The possible options are:
 - **Link Local** — The IP address is link local; non-routable and can be used for communication on the same network only. A Link Local address has a prefix of 'FE80'.
 - **Global Unicast** — The IP address is a globally unique IPv6 Unicast address; visible and reachable from different subnets.
 - **Global Anycast** — The IP address is a globally unique IPv6 Anycast address; visible and reachable from different subnets.
 - **IPv6 Address** — Enter the IPv6 address assigned to the interface. The address must be a valid IPv6 address, specified in hexadecimal using 16-bit values between colons. An example of an IPv6 address is 2031:0:130F:0:0:9C0:876A:130D and the compressed version is represented as 2031:0:130F::9C0:876A:130D. Up to five IPv6 addresses (not including Link Local addresses) can be set per interface, with the limitation of up to 128 addresses per system.
 - **Prefix Length** — For global Unicast or Anycast, enter the length of the IPv6 prefix. The length is a decimal value that indicates how many of the high-order contiguous bits of the address comprise the prefix (the network portion of the address). The Prefix field is applicable only on a static IPv6 address defined as a *Global IPv6* address.
 - **EUI-64** — For global Unicast or Anycast, check to use the EUI-64 option.

Defining IPv6 Interfaces Using CLI Commands

The following table summarizes the CLI commands for setting fields displayed in the **IPv6 Interface** pages.

Table 9-26. IPv6 Interfaces CLI Commands

CLI Command	Description
<code>ipv6 enable [no-autoconfig]</code> <code>no ipv6 enable</code>	Enables the IPv6 addressing mode on an interface. Use the no form of this command to disable the IPv6 addressing mode on an interface
<code>ipv6 address autoconfig</code> <code>no ipv6 address autoconfig</code>	Enables automatic configuration of IPv6 addresses, using stateless auto configuration on an interface. Addresses are configured depending on the prefixes received in Router Advertisement messages. Use the no form of this command to disable address auto configuration on the interface.
<code>ipv6 icmp error-interval</code> <code>milliseconds [bucketsize]</code> <code>no ipv6 icmp error-interval</code>	Configures the rate limit interval and bucket size parameters for IPv6 Internet Control Message Protocol (ICMP) error messages. Use the no form of this command to return the interval to its default setting.
<code>ipv6 address ipv6-</code> <code>address/prefix-length [eui-64]</code> <code>[anycast]</code> <code>no ipv6 address [ipv6-</code> <code>address/prefix-length] [eui-</code> <code>64]</code>	Configures an IPv6 address for an interface. Use the no form of this command to remove the address from the interface.

Table 9-26. IPv6 Interfaces CLI Commands (Continued)

CLI Command	Description
<code>ipv6 address <i>ipv6-address/prefix-length link-local</i></code>	Configures an IPv6 link-local address for an interface.
<code>no ipv6 address link-local</code>	Use the no form of this command to return to the default link local address on the interface.
<code>ipv6 unreachable</code>	Enables the generation of ICMP for IPv6 (ICMPv6) unreachable messages for packets arriving on a specified interface.
<code>no ipv6 unreachable</code>	Use the no form of this command to prevent the generation of unreachable messages.
<code>ipv6 nd dad attempts <i>attempt</i></code>	Configures the number of consecutive neighbor solicitation messages that are sent on an interface while Duplicate Address Detection (DAD) is performed on the unicast IPv6 addresses of the interface.
<code>show ipv6 interface</code> <code>[[<i>gigabitethernet</i> <i>tengigabitethernet</i>] <i>port-number</i> <i>vlan-vlan-id</i> <i>port-channel LAG-number</i>]</code>	Displays the usability status of interfaces configured for IPv6.
<code>show ipv6 icmp error-interval</code>	Displays the IPv6 ICMP error interval.

The following is a sample script to configure IPv6 using CLI:

Table 9-27. Sample CLI Script to Configure IPv6 on a Port

CLI Command	Description
console# config	Enter Global Configuration mode.
console(config)# interface vlan 1	Enter VLAN mode for VLAN 1.
console(config-if)# ipv6 enable	Enable IPv6 (dynamic).
console(config-if)# ipv6 address 5::1/64	Set the IPv6 address (static)

IPv6 Default Gateway

Use the **IPv6 Default Gateway** pages to configure and view the default IPv6 router addresses. This list contains routers that are candidates to become the switch default router for non-local traffic. The switch randomly selects a router from the list. The switch supports one static IPv6 default router. Dynamic default routers are routers that have sent router advertisements to the switch IPv6 interface.

When adding or deleting IP addresses, the following events occur:

- When removing an IP interface, all of its default gateway IP addresses are removed.
- Dynamic IP addresses cannot be removed.
- An alert message is displayed after a user attempts to insert more than one IP address.
- An alert message is displayed when attempting to insert a non-Link Local type address.

To configure a router:

- 1 Click **System > IP Addressing > IPv6 Default Gateway** in the tree view to display the **IPv6 Default Gateway: Summary** page.

Figure 9-20. IPv6 Default Gateway: Summary

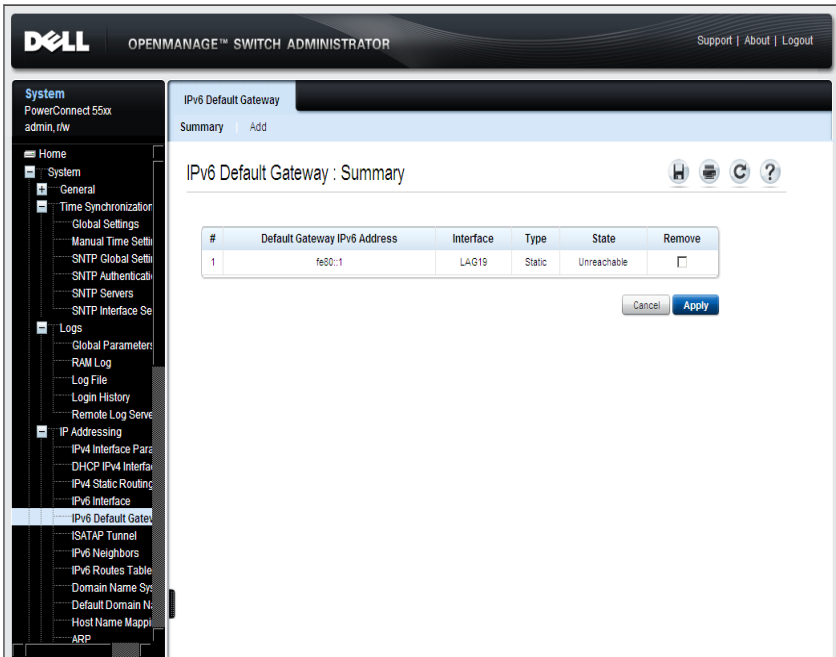

The previously-defined routers are displayed with the following fields:

- **IPv6 Default IPv6 Address** — The router’s address.
- **Interface** — The interface on which the router is accessed.
- **Type** — The means by which the default gateway was configured. The possible options are:
 - **Static** — The default gateway is user-defined.
 - **Dynamic** — The default gateway is dynamically configured through router advertisement.

- **State** — The router’s status. The possible options are:
 - **Incomplete** — Address resolution is in progress and the link-layer address of the default gateway has not yet been determined.
 - **Reachable** — The default gateway is known to have been reachable recently (within tens of seconds ago).
 - **Stale** — The default gateway is no longer known to be reachable but until traffic is sent to the default gateway, no attempt is made to verify its reachability.
 - **Delay** — The default gateway is no longer known to be reachable, and traffic has recently been sent to the default gateway. Rather than probe the default gateway immediately, however, there is a delay sending probes for a short while in order to give upper-layer protocols a chance to provide reachability confirmation.
 - **Probe** — The default gateway is no longer known to be reachable, and Unicast Neighbor Solicitation probes are being sent to verify reachability.
 - **Unreachable** — No reachability confirmation was received.
- 2 To add an IPv6 default gateway, click **Add**, and enter the fields:
- **IPv6 Address Type** — Displays that the IP address was added to the interface through a link local address.
 - **Link Local Interface** — Displays the outgoing interface through which the default gateway can be reached.
 - **Default Gateway IPv6 Address** — Enter the Link Local IPv6 address of the default gateway.

Defining IPv6 Default Gateway Parameters Using CLI Commands

The following table summarizes the CLI commands for setting fields displayed in the **IPv6 Default Gateway** pages

Table 9-28. IPv6 Default Gateway CLI Commands

CLI Command	Description
<code>ipv6 default-gateway <i>ipv6-address</i></code>	Defines an IPv6 default gateway.

Table 9-28. IPv6 Default Gateway CLI Commands (Continued)

CLI Command	Description
<code>show ipv6 route</code>	Displays the current state of the IPv6 routing table.

The following are examples of these CLI command:

```
console(config)# ipv6 default-gateway fe80::abcd
console(config-if)# do show ipv6 route
Codes: L - Local, S - Static, I - ICMP, ND - Router
Advertisement
The number in the brackets is the metric.
L 3003::/64 is directly connected, VLAN 20 Lifetime Infinite
L 4003::/64 is directly connected, VLAN 20 Lifetime Infinite
L 5003::/64 is directly connected, VLAN 20 Lifetime Infinite
L 6003::/64 is directly connected, VLAN 20 Lifetime Infinite
```

ISATAP Tunnel

To deliver IPv6 addresses in an IPv4 network, a tunneling process must be defined that encapsulates IPv6 packets in IPv4 packets.

The Intra-Site Automatic Tunnel Addressing Protocol (ISATAP) is an IPv6 transition mechanism that is used to transmit IPv6 packets between dual-stack nodes (nodes that can accept both IPv4 and IPv6 addresses) on top of an IPv4 network.

When enabling ISATAP on a tunnel interface, an explicit IPv4 address is configured as the tunnel source, or an automatic mode exists, where the lowest IPv4 address is assigned to an IP interface. This source IPv4 address is used for setting the tunnel interface identifier according to ISATAP addressing conventions. When a tunnel interface is enabled for ISATAP, the tunnel source must be set for the interface in order for the interface to become active.

An ISATAP address is represented using the [64-bit prefix]:0:5EFE:w.x.y.z, where 5EFE is the ISATAP identifier and w.x.y.z is a public or private IPv4 address. Thus, a Link Local address will be represented as FE80::5EFE:w.x.y.z

After the last IPv4 address is removed from the interface, the ISATAP IP interface state becomes inactive and is represented as Down, however the Admin state remains Enabled.

When defining tunneling, note the following:

- An IPv6 Link Local address is assigned to the ISATAP interface. The initial IP address is assigned to the interface, and the interface state becomes **Active**.
- If an ISATAP interface is active, the ISATAP router IPv4 address is resolved via DNS by using ISATAP-to-IPv4 mapping. If the ISATAP DNS record is not resolved, the ISATAP host name-to-address mapping is searched in the host name cache.
- When an ISATAP router IPv4 address is not resolved via the DNS process, the status of the ISATAP IP interface remains Active. The system does not have a default gateway for ISATAP traffic until the DNS procedure is resolved.
- In order for an ISATAP Tunnel to work properly over an IPv4 network, an ISATAP router is must be set up.

To define an IPv6 ISATAP tunnel:

- 1 Click **System > IP Addressing > IPv6 ISATAP Tunnel** in the tree view to display the ISATAP Tunnel page.

Figure 9-21. IPv6 ISATAP Tunnel

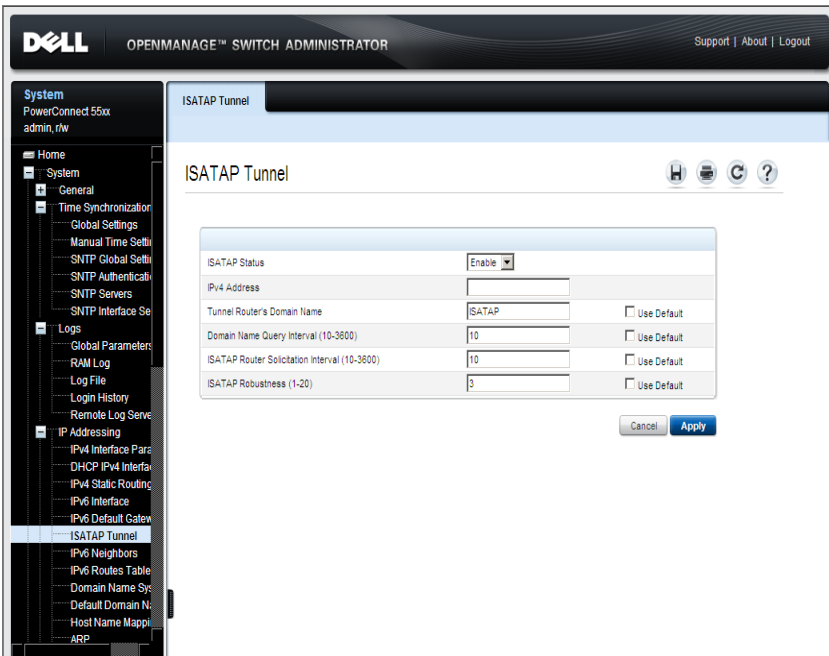

- 2 Enter the fields:
 - **ISATAP Status** —Enable/disable the status of ISATAP on the device.
 - **IPv4 Address Type** — Enter the source of the IPv4 address used by the tunnel. The options are:
 - **Auto** —Use the dynamic address.
 - **None** —Disable the ISATAP tunnel
 - **Manual** —Use the manual address assigned.
 - **IPv4 Address** — Enter the local (source) IPv4 address of a tunnel interface.

- **Tunnel Router's Domain Name** — Enter a specific automatic tunnel router domain name.
- **Domain Name Query Interval (10 - 3600)** — Enter the interval between DNS queries (before the IP address of the ISATAP router is known) for the automatic tunnel router domain name.
- **ISATAP Router Solicitation Interval (10 - 3600)** — Enter the interval between router solicitations messages when there is no active router.
- **ISATAP Robustness (1 - 20)** — Enter the number of DNS Query/Router Solicitation refresh messages that the device sends per second.

Select the **Use Default** option to use the default setting of a field.

Defining ISATAP Tunnel Parameters Using CLI Commands

The following table summarizes the CLI commands for setting fields displayed in the **ISATAP Tunnel** pages.

Table 9-29. ISATAP Tunnel CLI Commands

CLI Command	Description
<code>interface tunnel <i>number</i></code>	Enters tunnel interface configuration mode.
<code>tunnel mode ipv6ip {<i>isatap</i>}</code> <code>no tunnel mode ipv6ip</code>	Configures an IPv6 transition mechanism global support mode. Use the no form of this command to remove an IPv6 transition mechanism.
<code>tunnel isatap router <i>router_name</i></code> <code>no tunnel isatap router</code>	Configures a global string that represents a specific automatic tunnel router domain name. Use the no form of this command to remove the string associated with the router domain name and restore the default configuration.
<code>tunnel source {<i>auto</i> <i>ip-address</i> <i>ipv4-address</i>}</code> <code>no tunnel source</code>	Sets the local (source) IPv4 address of a tunnel interface. Use the no form of the command to delete the tunnel local address.

Table 9-29. ISATAP Tunnel CLI Commands (Continued)

CLI Command	Description
tunnel isatap query-interval <i>seconds</i>	Configures the interval between DNS Queries (before the IP address of the ISATAP router is known) for the automatic tunnel router domain name. Use the no form of this command to restore the default configuration.
no tunnel isatap query-interval	
tunnel isatap solicitation-interval <i>seconds</i>	Configures the interval between ISATAP router solicitations messages (when there is no active ISATAP router). Use the no form of this command to restore the default configuration.
no tunnel isatap solicitation-interval	
tunnel isatap robustness <i>number</i>	Configures the number of DNS Query/Router Solicitation refresh messages that the device sends. Use the no form of this command to restore the default configuration.
no tunnel isatap robustness	
show ipv6 tunnel	Displays information on the ISATAP tunnel.

The following is an example of a CLI script to create a tunnel:

Table 9-30. ISATAP Tunnel CLI Script

CLI Command	Description
console#config	Enter Global Configuration mode.
console(config)# interface <i>vlan</i> 1	Enter Interface mode for VLAN 1.
console(config-if)# ip address 10.5.225.40 /27	Configure an IP address with prefix length of 27.
console(config-if)# ip default-gateway 10.5.225.33	Set the address of the default gateway and exit Interface mode.
console(config-if)# exit	

Table 9-30. ISATAP Tunnel CLI Script

CLI Command	Description
console (config)# ip domain lookup	Enable DNS lookup
console(config)# ip name-server 176.16.1.18	Define DNS server
console(config)# interface tunnel 1	Enter tunnel mode
console(config-tunnel)# tunnel mode ipv6ip isatap	Enable tunnel.
console(config-tunnel)# tunnel source auto	The system minimum IPv4 address will be used as the source address for packets sent on the tunnel interface.
console(config-tunnel)# do show ipv6 tunnel	Display tunnel configuration

IPv6 Neighbors

The Neighbors feature is similar in functionality to the IPv4 Address Resolution Protocol (ARP) feature. It enables detecting Link Local addresses within the same subnet, and includes a database for maintaining reachability information about active neighbors.

The device supports a total of up to 64 neighbors, obtained statically or dynamically.

When removing an IPv6 interface, all neighbors entered statically or learned dynamically, are removed.

To add an IPv6 neighbor:

- 1 Click **System > IP Addressing > IPv6 Neighbors** in the tree view to display the **IPv6 Neighbors: Summary** page.

Figure 9-22. IPv6 Neighbors: Summary

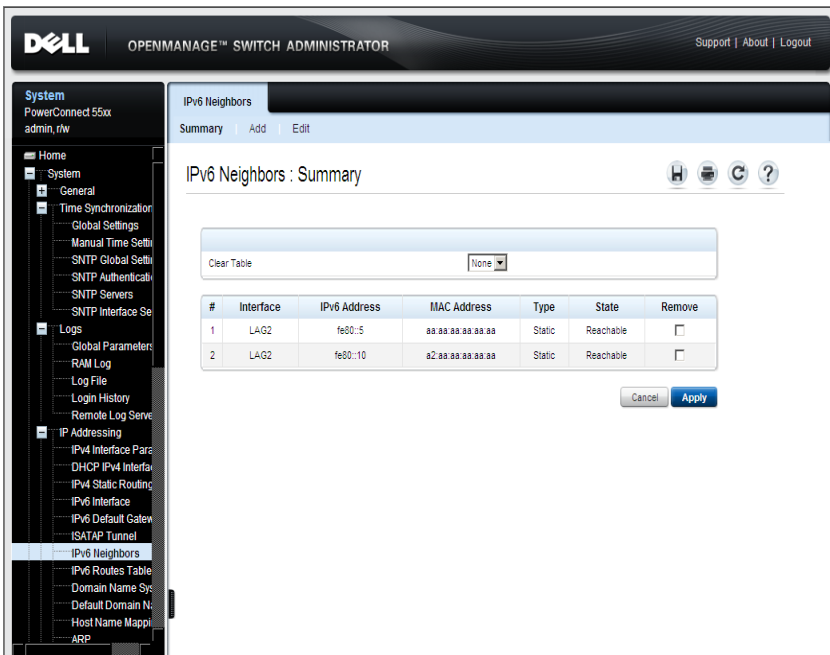

The previously-defined neighbors are displayed along with their states.
The possible states are:

- **Incomplete** — An address resolution is in progress, and the link-layer address of the neighbor has not yet been determined.
 - **Reachable** — The neighbor is known to have been reachable recently (within tens of seconds).
 - **Stale** — The neighbor is no longer known to be reachable, but until traffic is sent to the neighbor, no attempt is made to verify its reachability.
 - **Delay** — The neighbor is no longer known to be reachable, and traffic has recently been sent to the neighbor. Rather than probe the neighbor immediately, however, there is a delay sending probes for a short while, in order to give upper-layer protocols a chance to provide reachability confirmation.
 - **Probe** — The neighbor is no longer known to be reachable, and Unicast Neighbor Solicitation probes are being sent to verify reachability.
- 2** To clear the Neighbors table, select one of the following options:
- **None** — Does not clear any entries.
 - **Static Only** — Clears the static entries.
 - **Dynamic Only** — Clears the dynamic entries.
 - **All Dynamic and Static** — Clears the static and dynamic address entries.
- 3** To add a new IPv6 neighbor, click **Add**, and enter the fields:
- **IPv6 Interface** — Displays the interface on which IPv6 Interface is defined.
 - **IPv6 Address** — Enter the neighbor IPv6 address.
 - **MAC Address** — Enter the MAC address assigned to the interface.

- 4 To modify or remove an IPv6 neighbor, click **Edit**, and enter the fields described on the **Add** page.
- 5 If an entry for the specified IPv6 address already exists in the neighbor discovery cache, as learned through the IPv6 neighbor discovery process, you can convert the entry to a static entry. To do this, select **Static** in the **Type** field.

Defining IPv6 Neighbors Using CLI Commands

The following table summarizes the CLI commands for setting fields displayed in the **IPv6 Neighbors** pages.

Table 9-31. IPv6 Neighbors CLI Commands

CLI Command	Description
<code>ipv6 neighbor <i>ipv6_addr</i> { [<i>gigabitethernet</i> <i>tengigabitethernet</i>] <i>port-number</i> <i>vlan</i> <i>vlan-id</i> / <i>port-channel</i> <i>LAG-number</i> } <i>mac_addr</i></code>	Configures a static entry in the IPv6 neighbor discovery cache.
<code>no ipv6 neighbor <i>ipv6_addr</i> { [<i>gigabitethernet</i> <i>tengigabitethernet</i>] <i>port-number</i> <i>vlan</i> <i>vlan-id</i> / <i>port-channel</i> <i>LAG-number</i> }</code>	Use the no form of this command to remove a static IPv6 entry from the IPv6 neighbor discovery cache.
<code>show ipv6 neighbors { <i>static</i> <i>dynamic</i> } [<i>ipv6-address</i> <i>ipv6-address</i>] [<i>mac-address</i> <i>mac-address</i>] [[<i>gigabitethernet</i> <i>tengigabitethernet</i>] <i>port-number</i> <i>vlan</i> <i>vlan-id</i> / <i>port-channel</i> <i>LAG-number</i>]]</code>	Displays IPv6 neighbor discovery cache information.
<code>clear ipv6 neighbors</code>	Deletes all entries in the IPv6 neighbor discovery cache.

The following is an example of the CLI commands:

```
console# config
console(config)# ipv6 neighbor 3000::a31b vlan 1
001b.3f9c.84ea
console# show ipv6 neighbors dynamic
```

Interface	IPv6 Address	HW Address	State	Router
VLAN 1	3000::a31b	0001b.3f9c.84ea	Reachable	Yes

IPv6 Routes Table

The **IPv6 Routes Table** describes how to reach IPv6 destinations. The routing table is used to determine the next-hop address and the interface used for forwarding.

Each dynamic entry also has an associated invalidation timer value (extracted from Router Advertisements). This timer is used to delete entries that are no longer advertised.

To view IPv6 destinations and how they are reached:

- Click **System > IP Addressing > IPv6 Routes Table** in the tree view to display the **IPv6 Routes Table** page.

Figure 9-23. IPv6 Routes Table

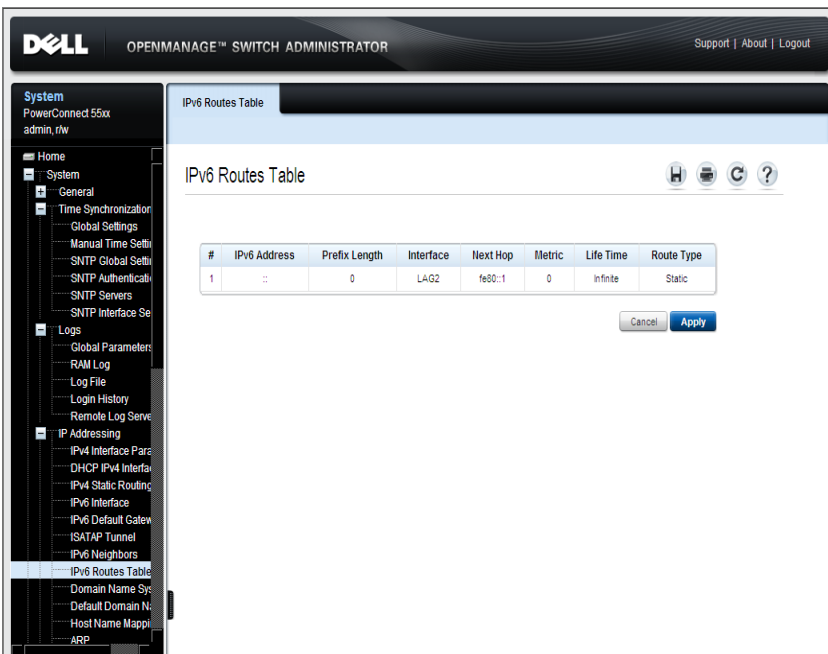

The following is displayed for each IP address:

- **IPv6 Address** — The destination IPv6 address.

- **Prefix Length** — The length of the IPv6 prefix. This field is applicable only when the destination address is defined as a global IPv6 address.
- **Interface** — The interface that is used to forward the packet. Interface refers to any Port, LAG or VLAN.
- **Next Hop** — The address to which the packet is forwarded on the route to the Destination address (typically the address of a neighboring router). This can be either a Link Local or Global IPv6 address.
- **Metric** — The value used for comparing this route to other routes with the same destination in the IPv6 route table. This is an administrative distance with the range of 0-255.
- **Life-Time** — The timeout interval of the route if no activity takes place. **Infinite** means the address is never deleted.
- **Route Type** — Specifies whether the destination is directly-attached and the means by which the entry was learned. The possible options are:
 - **Local** — A directly-connected route entry.
 - **Static** — Manually configured route, supported only for default gateway, learned through the Neighbor Discover (ND) process.
 - **ICMP** — The route was learned through ICMP Redirect messages, sent by the router.
 - **ND** — Route was learned by the ND protocol from Router Advertisement messages.

Viewing IPv6 Routes Table Parameters Using CLI Commands

The following table summarizes the CLI commands for setting fields displayed in the **IPv6 Routes Table** page.

Table 9-32. IPv6 Routes Table CLI Commands

CLI Command	Description
<code>show ipv6 route</code>	Displays the current state of the ipv6 routing table.

The following is an example of the CLI commands:

```
console> show ipv6 route
Codes: L - Local, S - Static, I - ICMP, ND - Router
Advertisement
The number in the brackets is the metric.
S::/0 via fe80::77 [0] VLAN 1 Lifetime Infinite
ND::/0 via fe80::200:cff:fe4a:dfa8 [0] VLAN 1 Lifetime
1784 sec
L 2001::/64 is directly connected, g2 Lifetime Infinite
L 2002:1:1:1::/64 is directly connected, VLAN 1 Lifetime
2147467 sec
L 3001::/64 is directly connected, VLAN 1 Lifetime
Infinite
L 4004::/64 is directly connected, VLAN 1 Lifetime
Infinite
L 6001::/64 is directly connected, g2 Lifetime Infinite
```

Domain Name System

The Domain Name System (DNS) converts user-defined domain names into IP addresses. Each time a domain name is assigned, the DNS service translates the name into a numeric IP address, for example, **www.ipexample.com** is translated into 192.87.56.2. DNS servers maintain domain name databases and their corresponding IP addresses.

To add a DNS server and specify the active DNS server:

- 1 Click **System > IP Addressing > Domain Name System** in the tree view to display the **Domain Name System: Summary** page.

Figure 9-24. Domain Name System: Summary

The screenshot shows the Dell OpenManage Switch Administrator interface. The left sidebar contains a tree view with the following items: System (PowerConnect 55xx, admin_rw), Home, System (General, Time Synchronization, Global Settings, Manual Time Setti, SNTP Global Setti, SNTP Authenticati, SNTP Servers, SNTP Interface Se), Logs, Global Parameters, RAM Log, Log File, Login History, Remote Log Serve, IP Addressing (IPv4 Interface Para, DHCP IPv4 Interfa, IPv4 Static Routing, IPv6 Interface, IPv6 Default Gatew, ISATAP Tunnel, IPv6 Neighbors, IPv6 Routes Table), Domain Name Sys, Default Domain N, Host Name Mappi, and ARP.

The main content area is titled "Domain Name System" and has tabs for "Summary" and "Add". The "Summary" tab is active, displaying the "Domain Name System : Summary" page. At the top right of the page are icons for Home, Print, Refresh, and Help. Below the title is a "DNS Status" dropdown menu currently set to "Enable". A table lists the configured DNS servers:

#	DNS Server	Active Server	Remove Select All
1	50.1.1.33	<input checked="" type="radio"/>	<input type="checkbox"/>
2	50.1.1.44	<input type="radio"/>	<input type="checkbox"/>

At the bottom right of the table are "Cancel" and "Apply" buttons.

The list of previously-defined DNS servers is displayed.

- 2 To enable mapping of host names into IP addresses through a DNS server, select **DNS Status**.
- 3 To activate one of the currently-defined DNS servers, enable **Active Server**.

- 4 To add a DNS server, click **Add**, and enter the fields:
 - **Supported IP Format** — Select whether the IPv4 or IPv6 format is supported.
 - **IPv6 Address Type** — When the server supports IPv6, this specifies the type of static address supported. The possible options are:
 - **Link Local** — A Link Local address that is non-routable and used for communication on the same network only.
 - **Global** — A globally unique IPv6 address; visible and reachable from different subnets.
 - **Link Local Interface** — When the server supports an IPv6 Link Local address, this specifies the Link Local interface. The possible options are:
 - **VLAN** — The VLAN on which the IPv6 interface is configured.
 - **ISATAP** — The IPv6 interface is configured on an ISATAP tunnel.
 - **DNS Server** — Enter the IP address of the DNS server being added.
 - **DNS Server Currently Active** — Displays the DNS server that is currently active.
 - **Set DNS Server Active** — Check to activate the selected DNS server.

Configuring DNS Servers Using the CLI Commands

The following table summarizes the CLI commands for configuring the fields in the Domain Name System pages.

Table 9-33. DNS CLI Commands

CLI Command	Description
<code>ip domain lookup</code>	Enables DNS system for translating host names to IP addresses.
<code>ip name-server {server1-ipv4-address server1-ipv6-address} [server-address2 ...server-address8]</code>	Sets the available name servers. Up to eight name servers can be set. The no form of the command removes a name server.
<code>no ip name-server [server-address ... server-address8]</code>	

Table 9-33. DNS CLI Commands (Continued)

CLI Command	Description
clear host	Deletes entries from the host name-to-address cache.
clear host dhcp { <i>name</i> * }	Deletes entries from the host name-to-address mapping received from DHCP.
show hosts	Displays the default domain name, the list of name server hosts, the static and the cached list of host names and addresses

The following is an example of the CLI commands:

```
console (config)# ip domain lookup  
console(config)# ip name-server 176.16.1.18
```

Default Domain Names

A default domain name is used when an IP address cannot be mapped to a known domain name. This domain name is applied to all unqualified host names.

To define the default domain name:

- 1 Click **System > IP Addressing > Default Domain Name** to display the **Default Domain Name** page.

Figure 9-25. Default Domain Name

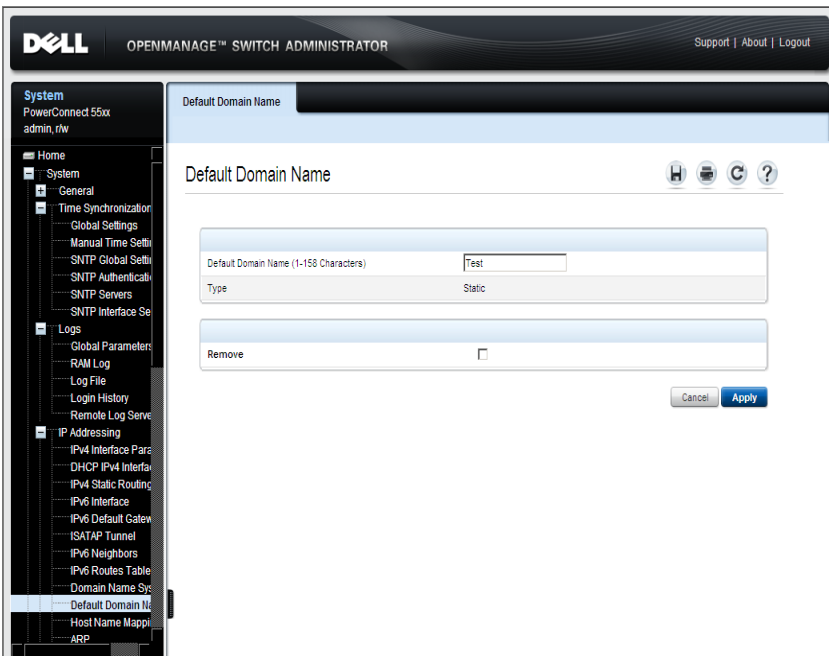

If there is a currently-defined default domain name, it is displayed.

- 2 Enter the **Default Domain Name (1 - 160 Characters)**.
Its **Type** is displayed, and has one of the following options:
 - **Dynamic** — The IP address was created dynamically.
 - **Static** — The IP address is a static IP address.

Defining Default Domain Names Using the CLI Commands

The following table summarizes the CLI commands for configuring the default domain name:

Table 9-34. Default Domain Name CLI Commands

CLI Command	Description
<code>ip domain-name name</code>	Defines a default domain name that the software uses to complete unqualified host names.
<code>no ip domain-name</code>	The no form of the command disables the use of the Domain Name System (DNS).

The following is an example of the CLI commands:

```
console(config)# ip domain-name dell.com
```

Host Name Mapping

Host names can be dynamically mapped to IP addresses through the **Domain Name System** pages, or statically through the **Host Name Mapping** page.

To assign IP addresses to static host names.

- 1 Click **System > IP Addressing > Host Name Mapping** in the tree view to display the **Host Name Mapping: Summary** page.

Figure 9-26. Host Name Mapping: Summary

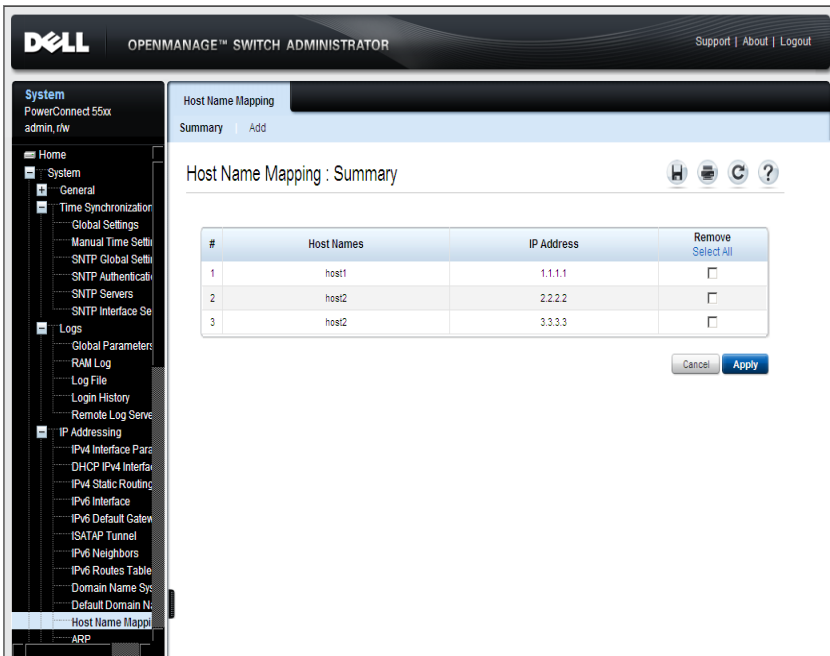

The currently-defined host names are displayed.

- 2 Click **Add** to add a new host name. Up to four IP addresses can be added.
- 3 For each IP address, enter the fields:
 - **Supported IP Format** — Select whether the IPv4 or IPv6 format is supported.

- **IPv6 Address Type** — When the server supports IPv6, this specifies the type of static address supported. The possible options are:
 - **Link Local** — A Link Local address that is non-routable and used for communication on the same network only.
 - **Global** — A globally unique IPv6 address; visible and reachable from different subnets.
 - **Link Local Interface** — When the server supports an IPv6 Link Local address, this specifies the Link Local interface. The possible options are:
 - **VLAN** — The VLAN on which the IPv6 interface is configured.
 - **ISATAP** — The IPv6 interface is configured on an ISATAP tunnel.
 - **Host Name (1-160 Characters)** — Enter the host name to be associated with the IP address entered below.
 - **IP Address** — Enter the IP address of the domain. Four addresses can be entered.
- 4 Click **Remove** to delete a host name. All addresses for this host name are deleted at the same time.

Mapping IP Addresses to Domain Host Names Using the CLI Commands

The following table summarizes the CLI commands for mapping domain host names to IP addresses.

Table 9-35. Domain Host Name CLI Commands

CLI Command	Description
ip host <i>name address</i> [<i>address2 address3</i> <i>address4</i>]	Defines the static host name-to-address mapping in the host cache
no ip host <i>name</i>	Removes the name-to-address mapping.
clear host { <i>name</i> *}	Deletes entries from the host name-to-address cache.
show hosts [<i>name</i>]	Displays the default domain name, list of name server hosts, the static and the cached list of host names and addresses.

The following is an example of the CLI commands:

```
console(config)# ip host accounting.abc.com 176.10.23.1
```

ARP

The Address Resolution Protocol (ARP) converts IP addresses into physical MAC addresses. ARP enables a host to communicate with other hosts when their IP addresses are known.

To add an IP/MAC address mapping:

- 1 Click **System > IP Addressing > ARP** in the tree view to display the **ARP: Summary** page.

Figure 9-27. ARP: Summary

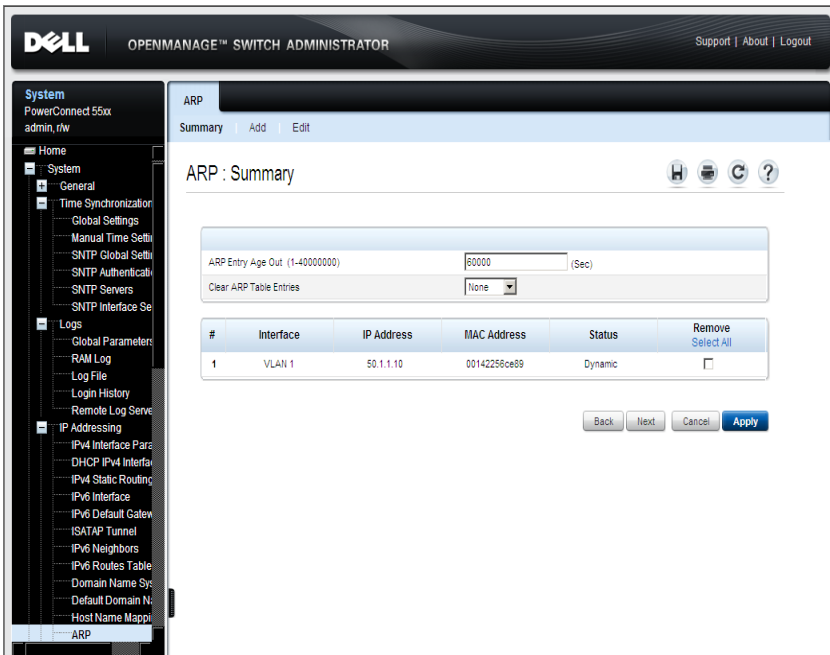

The entries in the table are displayed.

- 2** Enter the parameters:
 - **ARP Entry Age Out (1 - 4000000)** — Enter the amount of time in seconds that can pass between ARP requests for this address. After this period, the entry is deleted from the table.
 - **Clear ARP Table Entries** — Select the type of ARP entries that are cleared on all devices. The possible options are:
 - **None** — ARP entries are not cleared.
 - **All** — All ARP entries are cleared.
 - **Dynamic** — Only learned ARP entries are cleared.
 - **Static** — Only static ARP entries are cleared.
- 3** To add a mapping, click **Add**, and enter the fields:
 - **Interface** — Select an interface to be associated with the addresses.
 - **IP Address** — Enter the station IP address, which is associated with the MAC address filled in below.
 - **MAC Address** — Enter the station MAC address, which is associated in the ARP table with the IP address.
- 4** To change the status of a mapping from static to dynamic or vice versa, click **Edit** and enter the field:
 - **Status** — Select the entry's status. The possible options are:
 - **Static** — The entry was statically entered.
 - **Dynamic** — The entry was dynamically learned.

Configuring ARP Using the CLI Commands

The following table summarizes the CLI commands for setting fields displayed in the ARP pages.

Table 9-36. ARP CLI Commands

CLI Command	Description
<code>arp ip_addr mac_addr { [gigabitethernet tengigabitethernet] port-number vlan vlan-id port-channel LAG-number }</code>	Adds a permanent entry in the ARP cache.
<code>no arp ip-address</code>	Removes an ARP entry from the ARP Table.
<code>arp timeout seconds</code>	Configures how long an entry remains in the ARP cache. This command can be used in Global Configuration mode for all interfaces, or in Interface Configuration mode for a specific interface.
<code>clear arp-cache</code>	Deletes all dynamic entries from the ARP cache
<code>show arp</code>	Displays entries in the ARP Table.
<code>show arp configuration</code>	Displays the global and interface configuration of the ARP protocol

The following is an example of the CLI commands:

```

console(config)# arp 198.133.219.232 00-00-0c-40-0f-bc
console(config)# arp timeout 12000
console(config)# exit
console# show arp
ARP timeout: 12000 Seconds
Interface      IP Address      HW Address      Status
-----
gil/0/11      10.7.1.102     00:10:B5:04:DB:4B  dynamic
gil/0/12      10.7.1.135     00:50:22:00:2A:A4  static

```



UDP Relay

Switches do not typically route IP Broadcast packets between IP subnets. However, if configured, the switch can relay specific UDP Broadcast packets received from its IPv4 interfaces to specific destination IP addresses.

To configure the relaying of UDP packets received from a specific IPv4 interface with a destination UDP port:

- 1 Click **System > IP Addressing > UDP Relay** in the tree view to display the **UDP Relay: Summary** page.

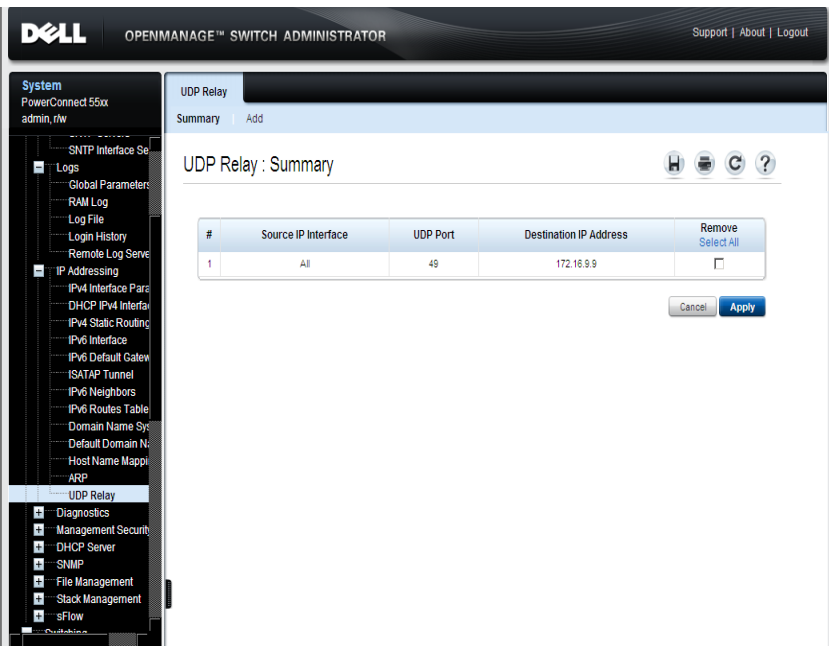
Figure 9-28. UDP Relay: Summary



The screenshot shows the Dell OpenManage Switch Administrator interface. The left sidebar contains a tree view with the following structure:

- System
 - PowerConnect 55xx
 - admin, f/w
 - SNTP Interface Se...
 - Logs
 - Global Parameters
 - RAM Log
 - Log File
 - Login History
 - Remote Log Serve...
 - IP Addressing
 - IPv4 Interface Para...
 - DHCP IPv4 Interfa...
 - IPv4 Static Routing
 - IPv6 Interface
 - IPv6 Default Gatew...
 - ISATAP Tunnel
 - IPv6 Neighbors
 - IPv6 Routes Table
 - Domain Name Sy...
 - Default Domain N...
 - Host Name Mapp...
 - ARP
 - UDP Relay
 - Diagnostics
 - Management Secur...
 - DHCP Server
 - SNMP
 - File Management
 - Stack Management
 - sFlow
 - Quarantine

The main content area displays the **UDP Relay: Summary** page. It includes a table with the following data:

#	Source IP Interface	UDP Port	Destination IP Address	Remove Select All
1	All	49	172.16.9.9	<input type="checkbox"/>

Below the table are **Cancel** and **Apply** buttons.

The UDP relays are displayed.

- 2 To add a UDP relay, click **Add**, and enter the fields:
 - **Source IP Address** — Select the source IP address to where the switch is to relay UDP Broadcast packets, based on a configured UDP destination port. The interface must be one of the IPv4 interfaces configured on the switch. Select **All** for all addresses.
 - **UDP Port (1 - 65535)** — Check **Default Services** to select all of the following default ports:
 - IEN-116 Name Service (port 42)
 - DNS (port 53)
 - NetBIOS Name Server (port 137)
 - NetBIOS Datagram Server (port 138)
 - TACACS Server (port 49)
 - Time Service (port 37)If **Default Services** are not selected, check the text box and enter a UDP port.
 - **Destination IP Address** — Enter the IP address that receives the UDP packet relays. If this field is 0.0.0.0, UDP packets are discarded. If this field is 255.255.255.255, UDP packets are flooded to all IP interfaces.

Configuring UDP Relay Using the CLI Commands

The following table summarizes the CLI commands for setting fields displayed in the **UDP Relay** pages.

Table 9-37. UDP Relay CLI Commands

CLI Command	Description
<code>ip helper-address {ip-interface all} address [udp-port-list]</code>	Enables the forwarding of User Datagram Protocol (UDP) broadcast packets received on an interface to a specific (helper) address.
<code>no ip helper-address {ip-interface all} address</code>	Use the no form of this command to disable the forwarding of broadcast packets to a specific (helper) address.

The following is an example of the CLI commands:

```
console (config)# ip helper-address all 172.16.9.9 49 53
```

```
console (config)# do show ip helper-address
```

```
Interface      Helper Address    UDP Ports
```

```
-----
```

```
All           172.16.9.9       49,53
```

Diagnostics

This section describes how to perform cable tests on copper and fiber optic cables.

It contains the following sections:

- Integrated Cable Test
- Optical Transceiver Diagnostics

Integrated Cable Test

Time Domain Reflectometry (TDR) technology is used to test the quality and characteristics of a copper cable attached to a port. Cables up to 120 meters long can be tested. Cables can only be tested when the ports are in the down state, with the exception of Approximated Cable Length test.

This test can only be performed when the port is up and operating at 1 Gbps.

To perform a cable test and view the results:

- 1 Click **System > Diagnostics > Integrated Cable Test: Summary** in the tree view to display the **Integrated Cable Test: Summary** page.

Figure 9-29. Integrated Cable Test: Summary

The screenshot shows the Dell OpenManage Switch Administrator interface. The left sidebar contains a navigation tree with the following items: System (PowerConnect 55xx, admin, r/w), SNMP Interface Set, Logs (Global Parameters, RAM Log, Log File, Login History, Remote Log Serve), IP Addressing, Diagnostics (Integrated Cable Test), Optical Transceive, Management Security (DHCP Server, SNMP, File Management, Stack Management, sFlow), Switching, Network Security (Port Security, MAC Based ACL, MAC Based ACE, IPv4 Based ACL, IPv4 Based ACE, IPv6 Based ACL, IPv6 Based ACE, ACL Binding, Proprietary Protocol, Time Based ACL).

The main content area is titled "Integrated Cable Test" and "Summary | Test". Below the title is a "Unit ID" dropdown menu with "1" selected. The main content is a table titled "Integrated Cable Test : Summary".

#	Port	Test Result	Cable Fault Distance	Last Update	Cable Length
1	g1/0/1	-		-	Unknown length
2	g1/0/2	OK		01-Oct-2006 10:28:05	Less than 50m
3	g1/0/3	-		-	Unknown length
4	g1/0/4	OK		01-Oct-2006 10:28:145	Between 80-110m
5	g1/0/5	-		-	Unknown length
6	g1/0/6	-		-	Unknown length
7	g1/0/7	-		-	Unknown length
8	g1/0/8	Open Cable		01-Oct-2006 11:38:00	Unknown length
9	g1/0/9	-		-	Unknown length
10	g1/0/10	-		-	Unknown length
11	g1/0/11	-		-	Unknown length
12	g1/0/12	-		-	Unknown length
13	g1/0/13	-		-	Unknown length
14	g1/0/14	-		-	Unknown length

- 2 Select a unit in the stack in the **Unit ID** field. Results from previously-run tests on that unit are displayed.
- 3 Ensure that both ends of the copper cable are connected to a device.

- 4 Ensure that the cable is connected to tested port. Go to the **Test** tab.
- 5 Click **Test Now**. The copper cable and Approximate Cable Length tests are performed, and the following test results are displayed:
 - **Test Result** — Displays the cable test results. The possible options are:
 - **No Cable** — There is no cable connected to the port.
 - **Open Cable** — The cable is connected on only one side.
 - **Short Cable** — A short has occurred in the cable.
 - **OK** — The cable passed the test.
 - **Cable Fault Distance** — Displays the distance from the port where the cable error occurred.
 - **Last Update** — Displays the last time the port was tested.
 - **Approximate Cable Length** — Displays the approximate cable length.

Performing Integrated Cable Tests Using CLI Commands

The following table contains the CLI commands for performing integrated cable tests.

Table 9-38. Integrated Cable Test CLI Commands

CLI Command	Description
<code>test cable-diagnostics tdr interface[gigabitethernet tengigabitethernet] port-number</code>	Performs VCT tests.
<code>show cable-diagnostics tdr interface[gigabitethernet tengigabitethernet] port-number</code>	Shows results of last VCT tests on ports.
<code>show cable-diagnostics cable-length interface [gigabitethernet tengigabitethernet] port-number</code>	Displays the estimated copper cable length attached to a port.

The following is an example of the CLI commands:

```
console> enable
console# test cable-diagnostics tdr gi1/0/3
Cable is open at 100 meters.
console# show cable-diagnostics cable-length interface
gi2/0/5

Port          Length [meters]
-----
gi2/0/5      < 50
```

Optical Transceiver Diagnostics

The **Optical Transceiver Diagnostics** page displays the operating conditions reported by the SFP (Small Form-factor Pluggable) transceiver. Some information might not be available for SFPs that do not support the digital diagnostic monitoring standard SFF-8472.

The following is the list of the compatible SFPs:

- SFP:
 - X3366 — 1000Base-SX, Finisar FTLF8519P2BNL
 - U3650 — 1000Base-LX, Finisar FTRJ1319P1BTL
- SFP+:
 - N743D — SR, Finisar FTLX8571D3BCL
 - T307D — LR, Finisar FTLX1471D3BCL
 - C043H — LRM, Avago AFBR-707SDZ-D1
 - N198M — LRM, Finisar FTLX1371D3BCL

To view the results of optical fiber tests:

- Click **System > Diagnostics > Optical Transceiver Diagnostics** in the tree view to display the **Optical Transceiver Diagnostics** page.

Figure 9-30. Optical Transceiver Diagnostics

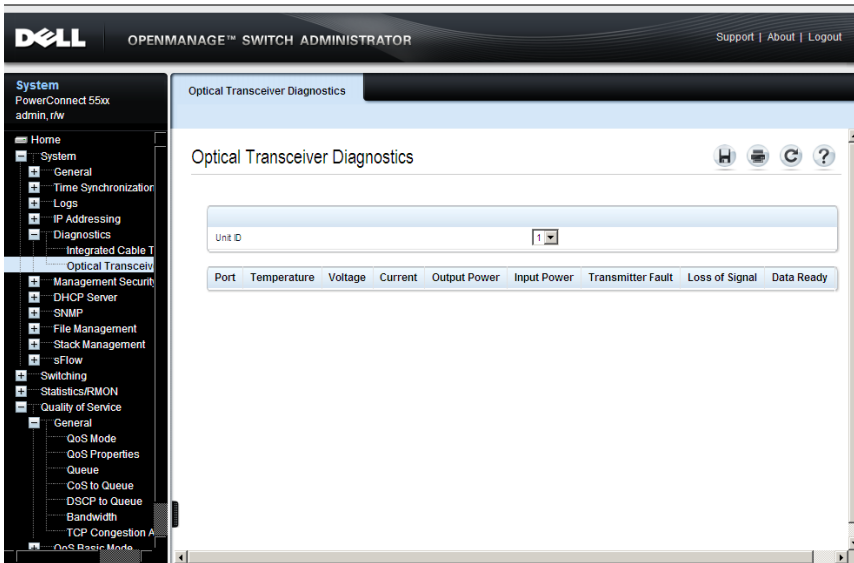

The following fields are displayed for the selected unit:

- **Port** — The port number on which the cable was tested.
- **Temperature** — The temperature (C) at which the cable is operating.
- **Voltage** — The voltage at which the cable is operating.
- **Current** — The current at which the cable is operating.
- **Output Power** — The rate at which output power is transmitted.
- **Input Power** — The rate at which input power is transmitted.
- **Transmitter Fault** — A fault occurred during transmission.
- **Loss of Signal** — A signal loss occurred in the cable.
- **Data Ready** — The transceiver has achieved power up, and data is ready.

Performing Fiber Optic Cable Tests Using CLI Commands

The following table contains the CLI command for performing fiber optic cable tests.

Table 9-39. Fiber Optic Cable Test CLI Commands

CLI Command	Description
<code>show fiber-ports optical-transceiver [interface [gigabitethernet tengigabitethernet] port-number] [detailed]</code>	Displays the optical transceiver diagnostics.

The following is an example of the CLI command:

```
console# show fiber-ports optical-transceiver detailed
```

Port	Temp [C]	Voltage	Current [aM]	Output [mWat]	Input [mWa]	POWER [mWa]	LOS
-----	----	-----	----	----	----	----	---
gi1/0/1	48	5.15	50	1.789	1.789	No	No
gi1/0/2	43	5.15	10	1.789	1.789	No	No

Management Security

This section describes the pages used to manage device security.

It contains the following topics:

- Access Profiles
- Profile Rules
- Authentication Profiles
- Select Authentication
- Active Users
- Local User Database
- Line Passwords
- Enable Password
- TACACS+
- Password Management
- RADIUS

Access Profiles

Access to management functions may be limited to users identified by:

- Ingress interface (Port, LAG, or VLAN)
- Source IP address
- Source IP subnet

Management access may be separately defined for the following types of management access methods:

- Telnet (CLI over Telnet sessions)
- Secure Telnet
- Web (HTTP)
- Secure Web (HTTPS, Using SSL)
- SNMP

This means, for example, that the set of managers allowed via Telnet may be different than the set of Web-based managers which is, in turn, may be different than the set of secure-web based managers, and so on.

A specific management access method may be completely disabled by denying all user access to it (e.g. denying all users access to CLI/Telnet management effectively disables CLI/Telnet as an available management interface to the system).

By default, management access to the system, through all methods, is enabled over all interfaces.



NOTE: If you enable management access through a physical port, all VLANs and IP interfaces on that port will be acceptable management traffic sources. If you enable management access through a VLAN, all ports and IP interfaces on that VLAN will be acceptable. If specific IP address(es) are specified, only traffic from the specified IP addresses on the appropriate ports will be accepted.

Access Profiles Rules

Each management access profile is composed of at least one rule, which acts as a filter, and defines the device management method, interface type, source IP address, network mask, and the device management access action.

Users can be blocked or permitted management access.

Rule priority sets the order in which the rules are implemented. Assigning an access profile to an interface denies access via other interfaces. If an access profile is not assigned to any interface, the device can be accessed by all interfaces.

A total of 256 rules can be defined for all Management Access profiles.

To add rules to existing access profiles, see "Profile Rules" on page 259.

Creating an Access Profile

To define an access profile with a single rule:

- 1 Click **System > Management Security > Access Profiles** in the tree view to display the **Access Profiles: Summary** page.

Figure 9-31. Access Profiles: Summary

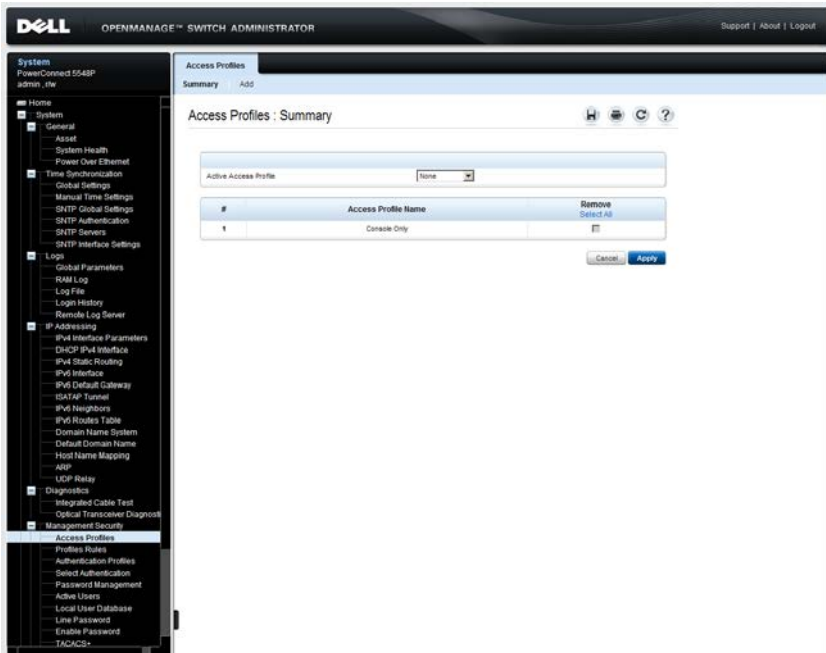

The currently-defined access profiles are displayed.

- 2 To activate an access profile, select it in the **Active Access Profile** field. If you select **Console Only**, active management of the device can only be performed using the console connection. This profile cannot be removed.
- 3 To add a new profile, click **Add**, and enter the fields:
 - **Access Profile Name (1-32 Characters)** — Enter a name for the access profile.

- **Rule Priority (1-65535)** — Enter the rule priority. Rules are applied to packets according to their priority. These can be viewed in the **Profile Rules: Summary** page.
- **Management Method** — Select the management method to which the access profile is applied. Users using this management method are authenticated using this access profile. The possible options are:
 - **All** — The access profile is applied to all management methods.
 - **Telnet** — The access profile is applied to Telnet users.
 - **Secure Telnet (SSH)** — The access profile is applied to SSH users.
 - **HTTP** — The access profile is applied to HTTP users.
 - **Secure HTTP (HTTPS)** — The access profile is applied to HTTPS users.
 - **SNMP** — The access profile is applied to SNMP users.
- **Interface** — Check the fields and select the interface type to which the rule applies.
- **Enable Source IP Address** — Check this parameter to restrict access, based on the source IP address. When this field is not selected, the source IP address cannot be entered into a configured rule.
- **Supported IP Format** — Select whether the IPv4 or IPv6 format is supported for the source IP addresses.
- **Source IP Address** — Enter the interface source IP address for which the rule applies. This is an optional field and indicates that the rule is valid for a subnetwork.
- **Network Mask** — Enter the IP subnetwork mask if **Supported IP Format** is IPv4.
- **Prefix Length** — Enter the number of bits that comprise the source IP address prefix, or the network mask of the source IP address.
- **Action** — Select whether to permit or deny management access to the defined interface. The possible options are:
 - **Permit** — Permits access to the device.
 - **Deny** — Denies access to the device.

Defining Access Profiles Using CLI Commands

The following table contains the CLI command for defining an access profile, without its rules. The CLI commands for defining the rules are described in "Defining Access Profile Rules Using CLI Commands" on page 260.

Table 9-40. Access Profile CLI Commands

CLI Command	Description
management access-list <i>name</i>	Defines an access-list for management.
no management access-list <i>name</i>	Use the no form of this command to delete an access list.

The following is an example of the CLI commands:

```
console(config)# management access-list mlist  
console(config-macl)#
```

Profile Rules

If an access profile already exists, meaning that a single rule has been defined on it, use the **Profile Rules** pages to add additional rules to it.

To add a rule to a management access profiles:

- 1 Click **System > Management Security > Profile Rules** in the tree view to display the **Profile Rules: Summary** page.

Figure 9-32. Profile Rules: Summary

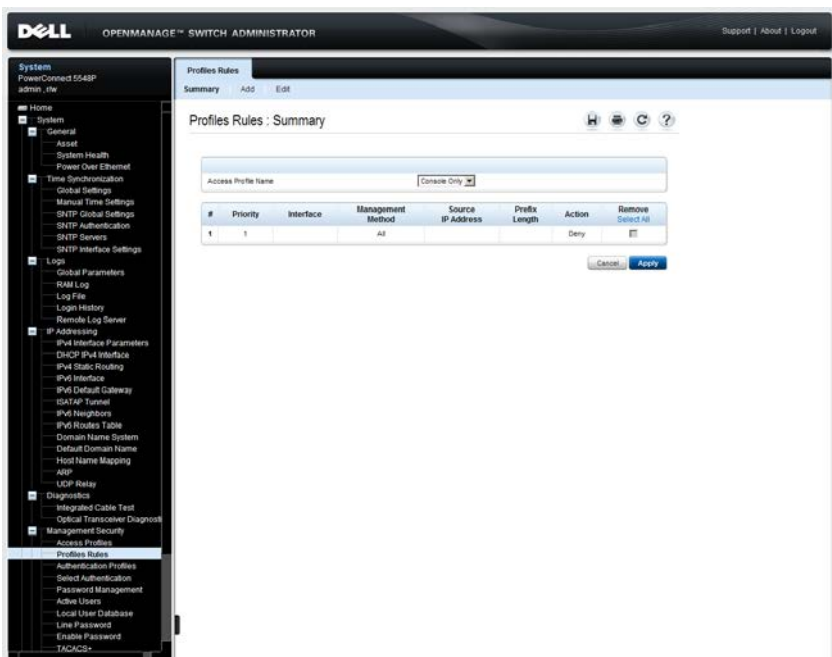

- 2 Select an access profile name. Its rules are displayed in the order that they will be implemented.
- 3 To add a rule to the selected management access profile, click **Add**.
- 4 Select a management access profile.
- 5 Complete the fields that are defined in **Access Profiles** pages.

Defining Access Profile Rules Using CLI Commands

The following table summarizes the CLI commands for adding rules to access profiles.

Table 9-41. Access Profiles CLI Commands

CLI Command	Description
<code>permit</code> [<i>gigabitethernet</i> <i>tengigabitethernet</i> <i>port-number</i>] <i>vlan</i> <i>vlan-id</i> <i>port-channel</i> <i>LAG-number</i>] [<i>service</i> <i>service</i>]	Sets port permit conditions for the management access list.
<code>permit ip-source</code> { <i>ipv4-address</i> / <i>ipv6-address</i> / <i>prefix-length</i> } [<i>mask</i> <i>mask</i> <i>prefix-length</i>] [[<i>gigabitethernet</i> <i>tengigabitethernet</i>] [<i>port-number</i> <i>vlan</i> <i>vlan-id</i> / <i>port-channel</i> <i>LAG-number</i>] [<i>service</i> <i>service</i>]	Sets port permitting conditions for the management access list, and the selected management method.
<code>deny</code> [[<i>gigabitethernet</i> <i>tengigabitethernet</i>] <i>port-number</i> <i>vlan</i> <i>vlan-id</i> / <i>port-channel</i> <i>LAG-number</i>] [<i>service</i> <i>service</i>]	Sets port denying conditions for the management access list, and the selected management method.
<code>deny ip-source</code> { <i>ipv4-address</i> / <i>ipv6-address</i> / <i>prefix-length</i> } [<i>mask</i> <i>mask</i> <i>prefix-length</i>] [[<i>gigabitethernet</i> <i>tengigabitethernet</i>] <i>port-number</i> <i>vlan</i> <i>vlan-id</i> / <i>port-channel</i> <i>LAG-number</i>] [<i>service</i> <i>service</i>]	Sets port denying conditions for the management access list, and the selected management method.
<code>management access-class</code> { <i>console-only</i> <i>name</i> }	Defines which access-list is used as the active management connections.
<code>no management access-class</code>	Use the no form of this command to disable management connection restrictions.

Table 9-41. Access Profiles CLI Commands (Continued)

CLI Command	Description
show management access-list [<i>name</i>]	Displays the active management access-lists.
show management access-class	Displays information about management access-class.

The following is an example of the CLI commands:

```
console(config)# management access-list mlist
console(config-macl)# permit gil/0/1
console(config-macl)# permit gil/0/2
console(config-macl)# deny gil/0/3
console(config-macl)# deny gil/0/4
console(config-macl)# exit
console(config)# management access-class mlist
console(config)# exit
console# show management access-list
mlist
-----
permit gil/0/1
permit gil/0/2
deny gil/0/3
deny gil/0/4
! (Note: all other access implicitly denied)
console# show management access-class
Management access-class is enabled, using access list
mlist
```

Authentication Profiles

In addition to access profiles, you can configure authentication for management access methods, such as SSH, console, Telnet, HTTP, and HTTPS.

User authentication can occur:

- Locally
- Via an external server, such as a TACACS+ or a RADIUS server

User authentication occurs in the order that the methods are selected, for example, if both the **Local** and **RADIUS** options are selected, the user is authenticated first locally. If the local user database is empty, the user is authenticated via the RADIUS server.

If an error occurs during the authentication, the next selected method is used.

If an authentication method fails, or the user has an insufficient privilege level, the user is denied access to the switch. The switch then stops, does not continue, and does not attempt to use the next authentication method.

If a privilege level is redefined, the user must also be re-defined.

User authentication can also be set to **None**, in which case no authentication is performed.

The process of configuring authentication for management access methods is divided into the following stages:

- Create an authentication profile, as described below
- Assign an authentication profile to a management method, as described in "Select Authentication" on page 265

To create an authentication profile:

- 1 Click **System > Management Security > Authentication Profiles** in the tree view to display the **Authentication Profiles: Summary** page.

Figure 9-33. Authentication Profiles: Summary

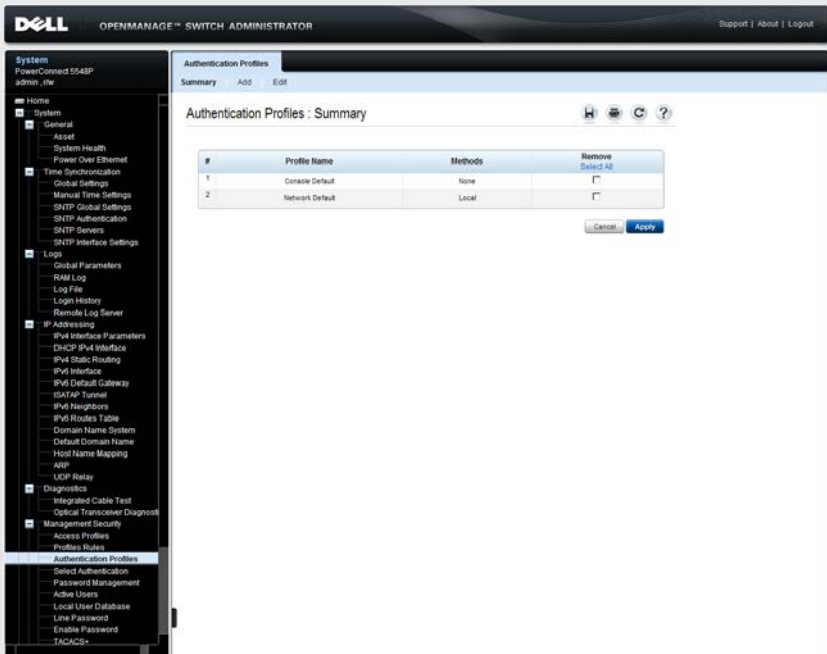

All currently-defined authentication profiles are displayed.

- 2 Click **Add** to add a new authentication profile, and enter the fields:
 - **Profile Name (1-12 Characters)** — Enter the name of the new authentication profile. Profile names cannot include blank spaces.
 - **Authentication Method: Optional Methods** — Select a user authentication methods that can be assigned to this authentication profile. The possible options are:
 - **Line** — The line password is used for user authentication (defined in "Line Passwords" on page 272).

- **Enable** — The enable (encrypted) password is used for authentication (defined in "Enable Password" on page 274).
- **Local** — The user authentication is performed by the device, which checks the user name and password for authentication.
- **RADIUS** — The user authentication is performed by the RADIUS server. For more information, see "RADIUS" on page 284.
- **TACACS+** — The user authentication is performed by the TACACS+ server. For more information, see "TACACS+" on page 275.
- **None** — No user authentication occurs.

Select a method by highlighting it in the **Optional Methods** list, and clicking on the right arrow to move it to the **Selected Methods** list.

Configuring an Authentication Profile Using CLI Commands

The following table summarizes the CLI commands for setting fields displayed in the **Authentication Profiles** pages.

Table 9-42. Authentication Profile CLI Commands

CLI Command	Description
aaa authentication login { default <i>list-name</i> } <i>method1</i> [<i>method2</i>]	Configures login authentication. Use the no form of the command to remove a login authentication profile.
no aaa authentication login { default <i>list-name</i> }	

The following is an example of the CLI commands:

```
console(config)# aaa authentication login default radius
local enable none
```

Select Authentication

After Authentication Profiles are defined, the Authentication Profiles can be assigned to Management Access methods, for example, console users can be authenticated by Authentication Profile 1, while Telnet users can be authenticated by Authentication Profile 2.

To assign an authentication profile to a management access method:

- 1 Click **System > Management Security > Select Authentication** in the tree view to display the **Select Authentication** page.

Figure 9-34. Select Authentication

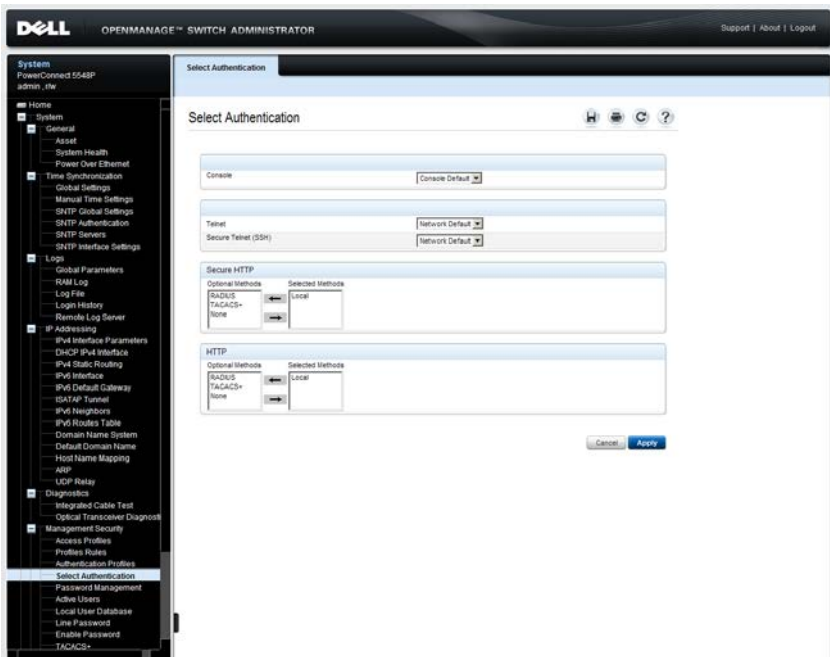

- 2 For the Console, Telnet and Secure Telnet (SSH) types of users, select either the default authentication profile or one of the previously-defined authentication profiles.

- 3 For Secure HTTP and HTTP types of users, select one or all of the **Optional Methods** and click the right-arrow to move them to the **Selected Methods**. The options are:
 - **Local** — Authentication occurs locally.
 - **None** — No authentication method is used for access.
 - **RADIUS** — Authentication occurs at the RADIUS server.
 - **TACACS+** — Authentication occurs at the TACACS+ server.

Assigning Access Authentication Profiles Using CLI Commands

The following table summarizes the CLI commands for setting fields displayed in the **Select Authentication** page.

Table 9-43. Select Authentication CLI Commands

CLI Command	Description
<code>aaa authentication enable { <i>default</i> <i>list-name</i> } <i>method</i> [<i>method2</i> ...]</code>	Indicates the authentication method list when accessing a higher privilege level from a remote Telnet, Console or SSH.
<code>no aaa authentication enable { <i>default</i> <i>list-name</i> }</code>	
<code>enable authentication [<i>default</i> <i>list-name</i>]</code>	Specifies the authentication method for accessing a higher privilege level from a remote Telnet or console.
<code>no enable authentication</code>	Use the no form of this command to restore the default authentication method
<code>login authentication [<i>default</i> <i>list-name</i>]</code>	Indicates the login authentication method list for a remote Telnet, Console or SSH.
<code>ip http authentication aaa login-authentication <i>method1</i> [<i>method2</i>]</code>	Indicates authentication methods for HTTP or HTTPS servers.
<code>no ip http authentication aaa login-authentication</code>	
<code>show authentication methods</code>	Displays information about the authentication methods.

The following is an example of the CLI commands that sets authentication for the console using the default method list that was previously-defined:

```
console(config)#line console  
console(config-line)# enable authentication default  
console(config-line)# login authentication default  
console(config-line)# exit
```

The following is an example of the CLI commands that creates an authentication method list for http server access (RADIUS and local):

```
console(config)# ip http authentication aaa login-  
authentication radius local  
console(config)# exit
```

Active Users

To view active users on the device:

- Click **System > Management Security > Active Users** in the tree view to display the Active Users page.

Figure 9-35. Active Users

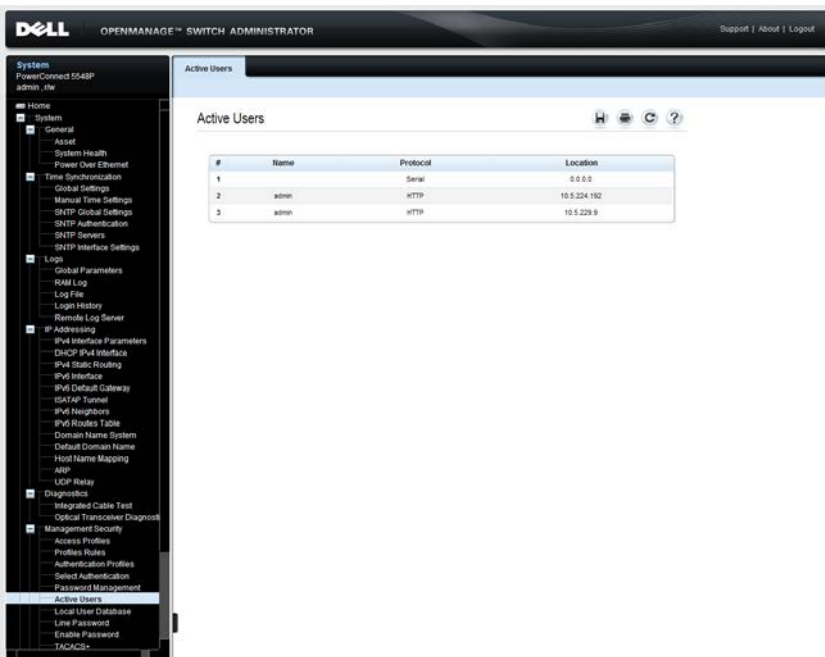

The following fields are displayed for all active users:

- **Name** — Active users logged into the device.
- **Protocol** — The management method by which the user is connected to the device.
- **Location** — The user's IP address.

Displaying Active Users Using CLI Commands

The following table summarizes the CLI commands for viewing active users connected to the device.

Table 9-44. Active Users CLI Commands

CLI Command	Description
show users	Displays information about active users.

The following example shows an example of the CLI command:

```
console> show users

Username      Protocol      Location
-----      -
Bob           Serial
John          SSH           172.16.0.1
Robert        HTTP          172.16.0.8
Betty         Telnet        172.16.1.7
```

Local User Database

Use the **Local User Database** pages to define users, passwords and access levels.

To add a new user:

- 1 Click **System > Management Security > Local User Database** in the tree view to display the **Local User Database: Summary** page.

Figure 9-36. Local User Database: Summary

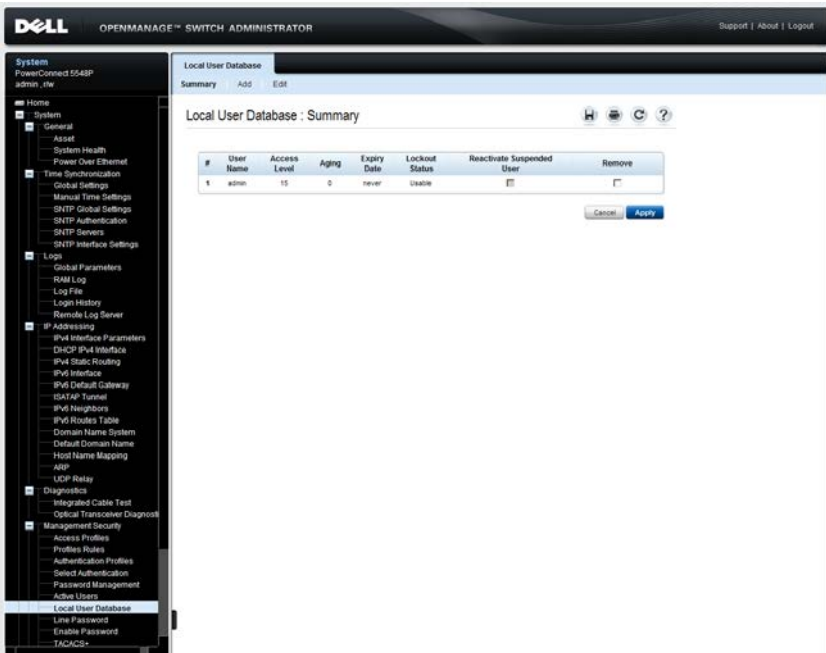

All users are displayed even if they have been suspended.

If a user has been suspended, it can be restored here by selecting the **Reactivate Suspended User** field.

- 2 To add a user, click **Add**, and enter the fields:
 - **User Name (1-20 characters)** — Enter the username of the user.

- **Access Level** — Select a user access level. The lowest user access level is 1 and 15 is the highest user access level. Users with access level 15 are Privileged Users, and only they can access and use the switch administrator.
- **Password (8-64 characters)** — Enter the password of the user.
- **Confirm Password** — Confirm the password of the user.

The following fields are displayed:

- **Expiry Date** — The expiration date of the user-defined password.
- **Lockout Status** — Specifies whether the user currently has access (status *Usable*), or whether the user is locked out due to too many failed authentication attempts since the user last logged in successfully (status *Locked*).
- **Reactivate Suspended User** — Check to reactivate the specified user’s access rights. Access rights can be suspended after unsuccessfully attempting to login.

Configuring Local Users Using CLI Commands

The following table summarizes the CLI commands for configuring local users.

Table 9-45. Local User CLI Commands

CLI Command	Description
username <i>name</i> { nopassword password <i>password</i> password encrypted <i>encrypted-password</i> }	Establishes a username-based authentication system.
username <i>name</i> [<i>privilege-level</i>]	Use the no form to remove a user name.
no username <i>name</i>	
set username <i>name</i> active	Reactivates a suspended user’s access rights.
show user accounts	Displays users information.

The following is an example of the CLI commands:

```
console(config)# username bob password lee privilege 15
console# set username bob active
```

Line Passwords

To add a line password for Console, Telnet, and Secure-Telnet users:

- 1 Click **System > Management Security > Line Passwords** in the tree view to display the **Line Password** page.

Figure 9-37. Line Password

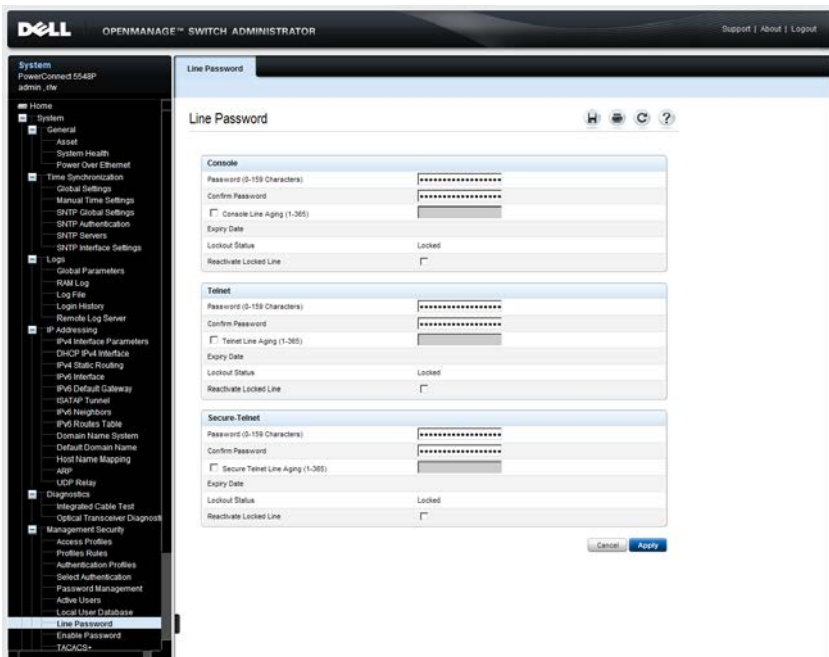

- 2 Enter the fields for each type of user, separately:
 - **Password (0 - 159 Characters)** — Enter the line password for accessing the device.
 - **Confirm Password** — Confirm the line password.

- **Console/Telnet/Secure Telnet Line Aging (1-365)** — Check to set the amount of time in days that elapses before a line password is aged out. Enter the number of days after which the password expires.
- **Expiry Date** — Displays the expiration date of the line password.
- **Lockout Status** — Displays whether the user currently has access (status **Usable**), or whether the user is locked out due to too many failed authentication attempts since the user last logged in successfully (status **Locked**).
- **Reactivate Locked Line** — Check to reactivate the line password for a Console/Telnet/Secure Telnet session. Access rights can be suspended after a number of unsuccessful attempts to log in.

Assigning Line Passwords Using CLI Commands

The following table summarizes the CLI commands for setting fields displayed in the **Line Password** page

Table 9-46. Line Password CLI Commands

CLI Command	Description
<code>line {console telnet ssh}</code>	Identifies a specific line for configuration and enters the Line Configuration command mode.
<code>password password</code> <code>[encrypted]</code>	Sets a password on a line. Use the no form of this command to
<code>no password</code>	remove the password.

The following is an example of the CLI commands:

```
console(config)# line console
console(config-line)# password dell
```

Enable Password

To set a local password to control access to Normal and Privilege levels activities.

- 1 Click **System > Management Security > Enable Passwords** in the tree view to display the **Enable Password** page.

Figure 9-38. Enable Password

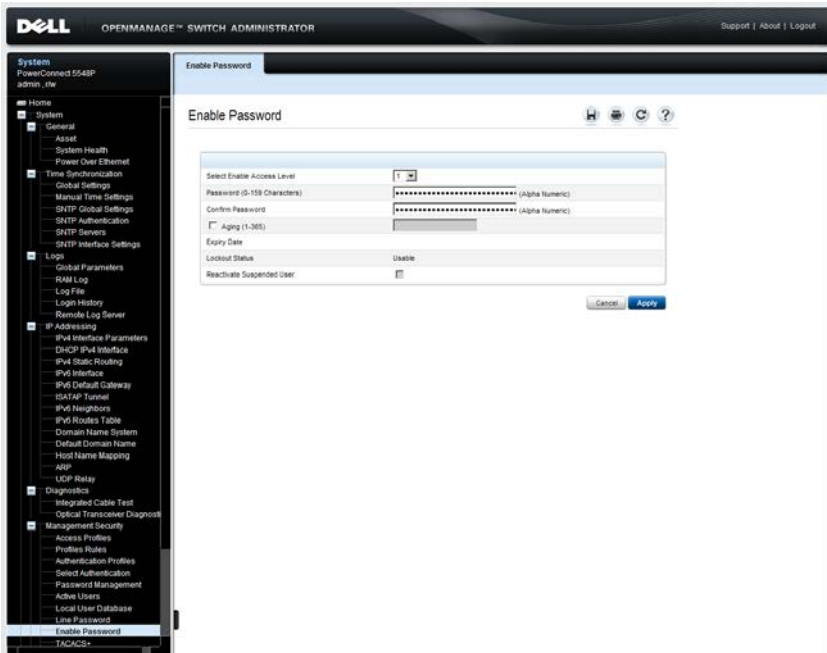

- 2 Enter the fields:

- **Select Enable Access Level** — Select the access level to associate with the enable password. The lowest user access level is 1 and 15 is the highest user access level. Users with access level 15 are Privileged Users, and only they can access and use the OpenManage Switch Administrator.
- **Password (0-159 characters)** — Enter the enable password.
- **Confirm Password** — Confirm the password.

- **Expiry Date** — If Aging is selected, displays the expiration date of the enable password.
- **Lockout Status** — Displays the number of failed authentication attempts since the user last logged in successfully (if the **Enable Login Attempts** checkbox is selected in the **Password Management** page.) Specifies **LOCKOUT**, when the user account is locked.
- **Reactivate Suspended User** — Check to reactivate the specified user’s access rights. Access rights can be suspended after unsuccessfully attempting to login.

Assigning Enable Passwords Using CLI Commands

The following table summarizes the CLI commands for setting fields displayed in the **Enable Password** page.

Table 9-47. Enable Password CLI Commands

CLI Command	Description
enable password [<i>level</i> <i>level</i>] <i>d</i> [encrypted]	Sets a local password to control access to user and privilege levels.
no enable password [<i>level</i> <i>level</i>]	Use the no form of this command to remove the password requirement.

The following is an example of the CLI commands:

```
console(config)# enable password level 15 secret
```

TACACS+

The device can act as a Terminal Access Controller Access Control System (TACACS+) client. TACACS+ provides centralized validation of users accessing the device, while still retaining consistency with RADIUS and other authentication processes.

TACACS+ provides the following services:

- **Authentication** — Provides authentication during login and via user names and user-defined passwords.
- **Authorization** — Performed at login after authentication. The TACACS+ server checks the privileges of the authenticated user.

The TACACS+ protocol ensures network integrity through encrypted protocol exchanges between the device and TACACS+ server.

To configure TACACS+ servers:

- 1 Click **System > Management Security > TACACS+** in the tree view to display the **TACACS+: Summary** page.

Figure 9-39. TACACS+: Summary

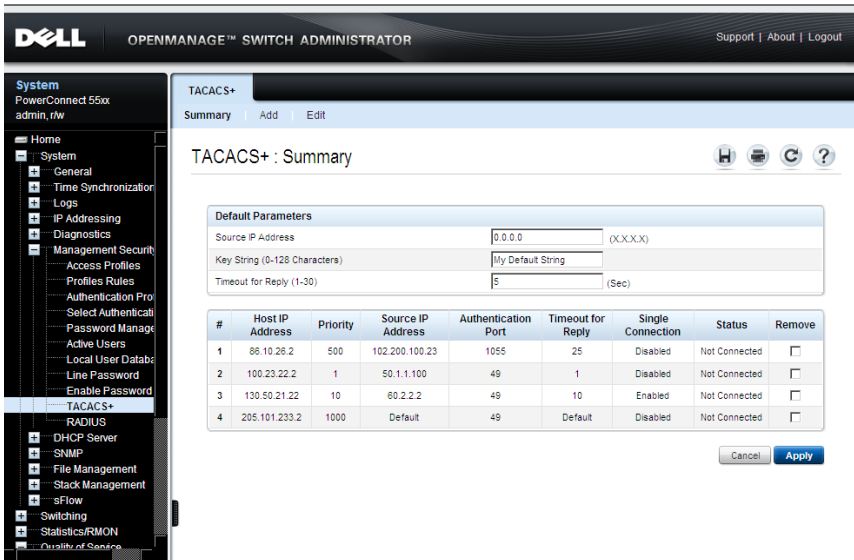

The list of currently-defined TACACS+ servers is displayed. The parameters for each server is displayed, along with its connection status.

- 2 Enter the default parameters for TACACS+ servers. These values are used unless values are added in the **TACACS+ Add** or **Edit** pages.
 - **Source IP Address** — The device IP address used for the TACACS+ session between the device and the TACACS+ server. The default is 0.0.0.0., which means that any IP address of the device can be used to communicate with the TACACS+ server.

- **Key String (1-128 Characters)** — The authentication and encryption key for TACACS+ communications between the device and the TACACS+ server. This key must match the encryption key sent by the TACACS+ server. This key is encrypted.
 - **Timeout for Reply (1-30)** — The amount of time that passes before the connection between the device and the TACACS+ server times out.
- 3** To add a TACACS+ server, click **Add**, and enter the fields on the page. The fields below are those that were not described on the **TACACS+ Summary** page.
- **Host IP Address** — Enter the TACACS+ server IP address.
 - **Priority (0-65535)** — Enter the order in which the TACACS+ servers are used if several are defined.
 - **Source IP Address** — Enter either specific device IP address for the TACACS+ server.
 - **Authentication Port (0-65535)** — Enter the port number through which the TACACS+ session occurs.
 - **Timeout for Reply (1-30)** — Enter the amount of time that passes before the connection between the device and the TACACS+ server times out.
 - **Single Connection** — Check to maintain a single open connection between the device and the TACACS+ server.

Wherever available, check **Use Default** to use a value that was entered in the **TACACS+: Summary** page.

Defining TACACS+ Settings Using CLI Commands

The following table summarizes the CLI commands for setting fields displayed in the **TACACS+ Settings** pages.

Table 9-48. TACACS+ CLI Commands

CLI Command	Description
tacacs-server host { <i>ip address/hostname</i> }[single-connection] [port <i>port-number</i>] [timeout <i>timeout</i>][key <i>key-string</i>][source <i>source</i>] [priority <i>priority</i>]	Configures a TACACS+ host. Use the no form of this command to delete the specified TACACS+ host.
no tacacs-server host { <i>ip-address hostname</i> }	
tacacs-server key <i>key-string</i>	Specifies the authentication and encryption key for all TACACS+ communications between the device and the TACACS+ server.
no tacacs-server key	Use the no form of this command to disable the key.
tacacs-server timeout <i>timeout</i>	Specifies the timeout value in seconds.
no tacacs-server timeout	
tacacs-server source-ip <i>source</i>	Specifies the source IP address.
no tacacs-server source-ip <i>source</i>	Use the no form of this command to restore the default configuration.
show tacacs [<i>ip-address</i>]	Displays configuration and statistics for a TACACS+ server.

The following is an example of the CLI commands:

```
console(config)# tacacs-server source-ip 172.16.8.1
console# show tacacs
Device Configuration
-----
IP Address  Status  Port      Single      TimeOut  Source IP  Priority
-----
1.1.1.11   Not      49        No          Global   Global     10
           Connected
1.1.1.21   Not      49        No          Global   Global     19
           Connected
1.1.1.31   Not      49        No          Global   Global     18
           Connected
1.1.1.41   Not      49        No          Global   Global     17
           Connected
Global values
-----
TimeOut : 5
-----
Source IP : 0.0.0.0
```

Password Management

Password management provides increased network security and improved password control. This feature is optional and must be enabled in the **Password Management** page.

Passwords for SSH, Telnet, HTTP, HTTPS, and SNMP access can be assigned security features that include:

- Minimum password lengths
- Password expiration dates (password aging)
- Prevention of frequent password reuse
- Lockout of users after failed login attempts
- Number of repeated characters allowed
- Number of different character classes required in the password. Numeric, alphabetic, and special characters are all character classes.

Password aging starts immediately after password management is enabled. However it is only effective if system time on the device is taken from an SNTP server. Passwords expire according to the user-defined expiration date/time. Ten days prior to password expiration, the device displays a password expiration warning message.

After the password has expired, users can log in a few additional times. During the remaining logins, an additional warning message displays informing the user that the password must be changed. If the password is not changed, users are locked out of the system, and can only log in using the console. Password warnings are logged in the SYSLOG file.



NOTE: Password aging is enabled only after setting the switch to use SNTP for setting time.

To define password management parameters:

- 1 Click **System > Management Security > Password Management** in the tree view to display the **Password Management** page.

Figure 9-40. Password Management

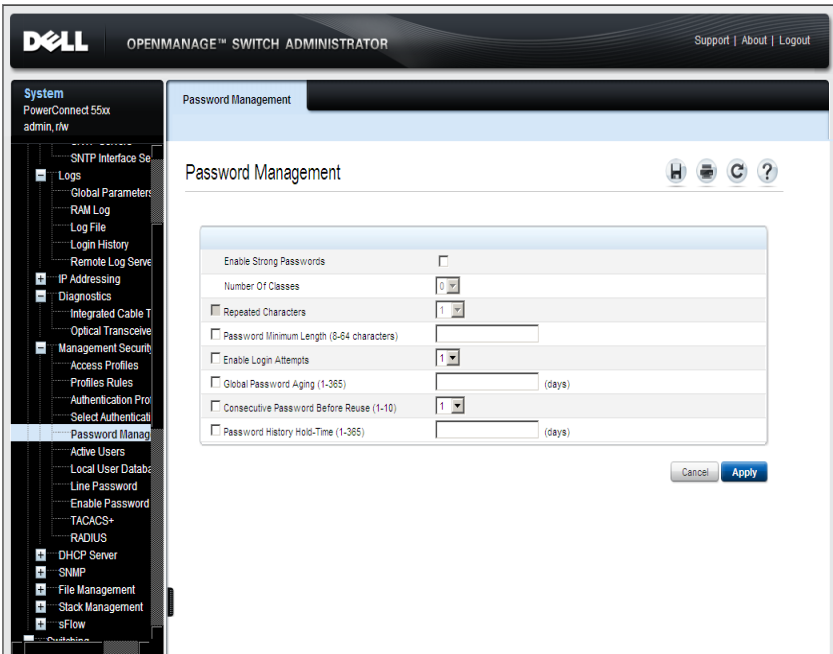

- 2 Check the required fields and enter their values:
 - **Enable Strong Passwords** — Check to enable this feature.
 - **Number of Classes** — Select a number of character classes. The character classes are: upper case characters, lower case characters, digits and punctuation. The number of character classes selected indicates how many different types of characters must be in the password.
 - **Repeated Characters** — Select the number of permissible repeated characters in the password.

- **Password Minimum Length (8-64 characters)** — When checked, specifies the minimum password length. Enter the minimum password length.
- **Enable Login Attempts** — When checked, enables locking a user out of the device when a faulty password is used more than the number of times entered. Select the maximum number of login attempts.
- **Global Password Aging (1-365)** — When checked, specifies that the password will expire in the number of days entered. Enter the number of days. This is only enabled after setting the switch to use SNTP for setting time
- **Consecutive Passwords Before Reuse (1-10)** — When checked, indicates the number of times a password must be changed, before the password can be reused. Select the number of times.
- **Password History Hold Time (1-365)** — When checked, the password history will be deleted after the number of days entered. Enter the number of days.

Password Management Using CLI Commands

The following table summarizes the CLI commands for setting fields displayed in the **Password Management** page.

Table 9-49. Password Management CLI Commands

CLI Command	Description
<code>passwords strength-check enable</code>	Enforces password strength checks.
<code>no passwords strength-check</code>	Use the no form of this command to disable enforcing password strength checks.
<code>passwords strength [max-limit repeated characters / minimum character-classes]</code>	Enforces limits of repeated characters and character classes.
<code>no passwords strength</code>	Use the no form of this command to disable enforcing limits of repeated characters and character classes.

Table 9-49. Password Management CLI Commands (Continued)

CLI Command	Description
<code>password min-length <i>length</i></code> <code>no password min-length</code>	Defines the minimum password length. Use the no form of this command to remove the restriction.
<code>passwords aging <i>days</i></code> <code>no passwords aging</code>	Enforces password aging. Use the no form of this command to return to default.
<code>password history <i>number</i></code> <code>no password history</code>	Defines the amount of times a password is changed, before the password can be reused.
<code>password history hold-time <i>days</i></code> <code>no password history hold-time</code>	Configures the duration that a password is relevant for tracking passwords history. Use the no form of this command to return to the default configuration.
<code>password lockout <i>number</i></code> <code>no password lockout</code>	Defines the number of times a faulty password is entered before the user is locked out of the device. Use the no form of this command to disable the lockout feature.
<code>show password configuration</code>	Displays password management information.

The following is a sample script that sets password strength rules and creates a user with a valid password.

Table 9-50. CLI Script to Configure Strong Password

CLI Command	Description
<code>console#configure</code>	Enable strong passwords.
<code>console(conf)# passwords strength-check enable</code>	

Table 9-50. CLI Script to Configure Strong Password

CLI Command	Description
<code>console(config)# password strength minimum character-classes 3</code>	Enable that passwords must contain at least three character classes.
<code>password min-length 8</code>	Enable that passwords must contain at least eight characters.
<code>console(config)# username admin privilege 15 password FGH123!@#</code>	Create a user named "admin" with privilege level 15 and password that fits the strength rules.

RADIUS

Remote Authentication Dial-In User Service (RADIUS) servers provide additional security for networks. Up to four RADIUS servers can be defined.

RADIUS servers provide a centralized authentication method for:

- Telnet Access
- Secure Shell Access
- Web Access
- Console Access

To add a RADIUS server:

- 1 Click **System > Management Security > RADIUS** in the tree view to display the **RADIUS: Summary** page.

Figure 9-41. RADIUS: Summary

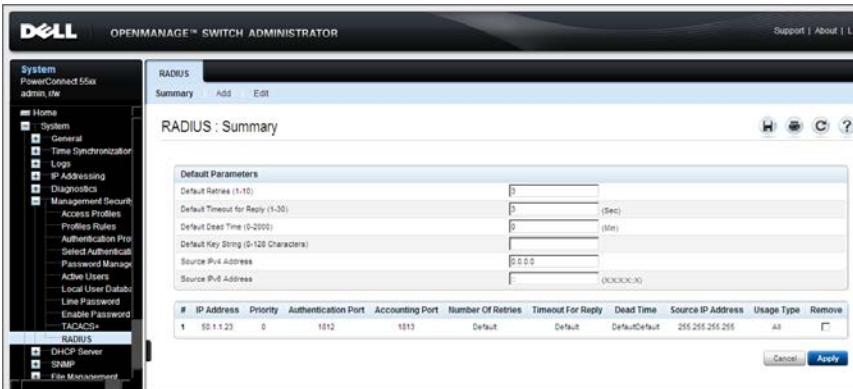

The RADIUS default parameters and previously-defined RADIUS servers are displayed.

- 2 Enter the default parameters to be used when these parameters are not entered for a specific server.
 - **Default Retries (1-10)** — The default number of transmitted requests sent to RADIUS server before a failure occurs.
 - **Default Timeout for Reply (1-30)** — The default amount of the time (in seconds) that the device waits for an answer from the RADIUS server before timing out.
 - **Default Dead time (0-2000)** — The default amount of time (in minutes) that a RADIUS server is bypassed for service requests.
 - **Default Key String (0-128 Characters)** — The Default Key string used for authenticating and encrypting all RADIUS communications between the device and the RADIUS server. This key is used for encryption.
 - **Source IPv4 Address** — The source IP v4 address that is used for communication with RADIUS servers.

- **Source IPv6 Address** — The source IP v6 address that is used for communication with RADIUS servers.
- 3** To add a RADIUS server, click **Add**, and enter the fields:
- **Supported IP Format** — Select whether the IPv4 or IPv6 format is supported.
 - **IP Address** — Enter the RADIUS server IP address.
 - **Priority (0-65535)** — Enter the priority of the authentication server being added. 0 is the highest value. This is used to configure the order in which servers are queried.
 - **Authentication Port (0-65535)** — Enter the authentication port used to verify the RADIUS server authentication. Enter 0 if you do not want this server to be used for authentication purposes.
 - **Accounting Port (0-65535)** — Enter the accounting port, which is the UDP port number of the RADIUS server used for accounting requests. Enter 0 if you do not want this server to be used for accounting purposes.
 - **Usage Type** — Enter the RADIUS server usage. The possible options are:
 - **Login** — Used for login authentication and/or accounting.
 - **802.1x** — Used for 802.1x authentication and/or accounting.
 - **All** — Used for all types of authentication and/or accounting.
- 4** Enter the following fields if you do not want to use the default values entered in the **RADIUS: Summary** page. If you do want to use the default values, check **Use Default** for these fields.
- **Number of Retries (1-10)** — Enter the number of requests sent to the RADIUS server before a failure occurs.
 - **Timeout for Reply (1-30)** — The amount of the time in seconds that the device waits for an answer from the RADIUS server before retrying the query, or switching to the next server.
 - **Dead Time (0-2000)** — The amount of time (in minutes) that a RADIUS server is bypassed for service requests.
 - **Key String (0-128 Characters)** — The key string used for authenticating and encrypting all RADIUS communications between the device and the RADIUS server.

- **Source IP Address** — The device IP address that is used for communication with RADIUS servers.

Defining RADIUS Servers Using CLI Commands

The following table summarizes the CLI commands for defining fields displayed on the RADIUS pages.

Table 9-51. RADIUS Server CLI Commands

CLI Command	Description
radius-server host { <i>ipv4-address ipv6-address ipv6z-address hostname</i> } [auth-port <i>auth-port-number</i>] [acct-port <i>acct-port-number</i>][timeout <i>timeout</i>] [retransmit <i>retries</i>] [deadtime <i>deadtime</i>] [key <i>key-string</i>] [source { <i>ipv4-address ipv6-address</i> }] [priority <i>priority</i>] [usage { <i>login 802.1x all</i> }]	Specifies a RADIUS server host. Use the no form of the command to delete the specified RADIUS server host.
no radius-server host { <i>ipv4-address ipv6-address hostname</i> }	
radius-server timeout <i>timeout</i>	Sets the interval for which a device waits for a server host to reply.
no radius-server <i>timeout</i>	Use the no form of this command to restore the default configuration.
radius-server source-ip <i>source-ip-address</i>	Specifies the source IPv4 address that will be used for the IPv4 communication with RADIUS servers.
no radius-server source-ip <i>source-ip-address</i>	Use the no form of this command to restore the default configuration.

Table 9-51. RADIUS Server CLI Commands (Continued)

CLI Command	Description
radius-server source-ipv6 <i>source-ipv6-address</i>	Specifies the source IPv6 address that will be used for the IPv6 communication with RADIUS servers.
no radius-server source-ipv6 <i>source-ipv6-address</i>	Use the no form of this command to restore the default configuration.
radius-server retransmit <i>retries</i>	Specifies the number of times the software searches the list of RADIUS server hosts.
no radius-server retransmit	Use the no form of this command to restore the default configuration.
radius-server deadtime <i>deadtime</i>	Configures unavailable servers to be skipped.
no radius-server deadtime	Use the no form of this command to restore the default configuration.
radius-server key <i>key-string</i>	Sets the authentication and encryption key for all RADIUS communications between the router and the RADIUS server.
no radius-server key	Use the no form of this command to restore the default configuration.
show radius-servers	Displays the RADIUS server settings.

The following is an example of CLI commands:

```
console(config)# radius-server host 192.168.10.1 auth-  
port 20 timeout 20  
console(config)# radius-server key enterprise-server  
console# show radius-servers
```

IP address	Port Auth	Port Acct	Time- Out	Ret- rans	Dead- Time	Source IP	Prio.	Usage
1.1.1.11	1812	1813	Global	Global	Global	Global	10	all
1.1.1.21	1812	1813	Global	Global	Global	Global	19	all
1.1.1.31	1812	1813	Global	Global	Global	Global	18	all
1.1.1.41	1812	1813	Global	Global	Global	Global	17	all
1.1.1.51	1812	1813	Global	Global	Global	Global	16	all

Global values

Timeout : 3
Retransmit : 3
Deadtime : 0
Source IP : 0.0.0.0
Source IPv6 : ::

DHCP Server

The switch can operate as either:

- DHCP client that obtains its own IP from a DHCP server, as described in "DHCP IPv4 Interface" on page 207
- DHCP server that allocates IP addresses to other devices, as described in this section

This section contains the following topics:

- DHCP Server Overview
- DHCP Server Properties
- Network Pool
- Excluded Addresses
- Static Hosts
- Address Binding

DHCP Server Overview

A DHCP server uses a defined pool of IP addresses (user-defined) from which it allocates IP addresses to DHCP clients.

The DHCP server can allocate IP addresses in the following modes:

- **Static Allocation** — The hardware address of a host is manually mapped to an IP address.
- **Permanent Allocation** — An IP address sent to the client through a standard request-reply mechanism, is owned by that client permanently (unless changes in the network environment/connections take place, for any reason).
- **Dynamic Allocation** — A client obtains a leased IP address for a specified period of time. The IP address is revoked at the end of this period, and the client must request another IP address.

DHCP Server Properties

If the device is configured to act as a DHCP server, pinging capability can be enabled. The DHCP server pings an IP address in the address pool before assigning that IP address to a requesting client. If the ping is unanswered, the DHCP server assumes that the address is not in use and assigns the address to the client.

To configure the device as a DHCP server:

- 1 Click **System > DHCP Server > DHCP Server Properties** in the tree view to display the **DHCP Server Properties** page.

Figure 9-42. DHCP Server Properties

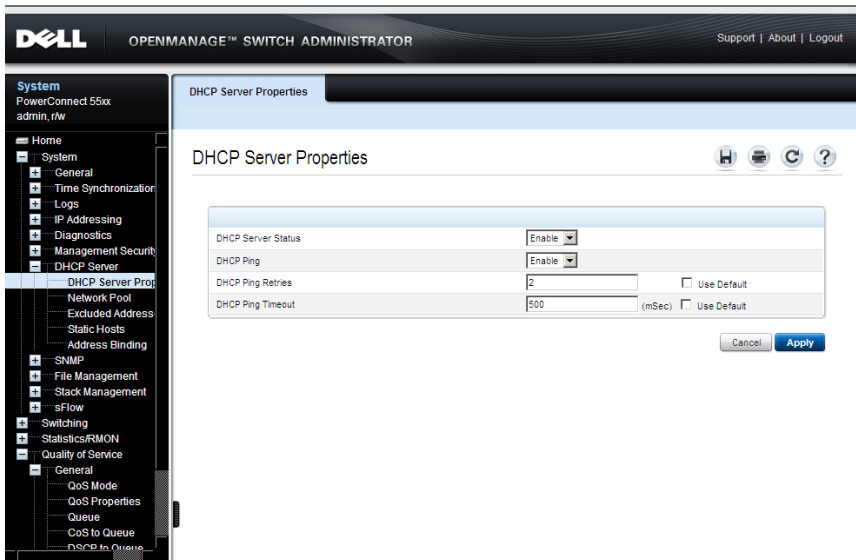

2 Enter the fields:

- **DHCP Server Status** — Enable/disable the ability of the device to function as a DHCP server.
- **DHCP Ping** — Enable/disable the DHCP server to ping the offered IP address before responding to a client request.
- **DHCP Ping Retries** — Enter the number of pings that are sent before discarding an IP address. Use **Default** reverts to the default Ping Retries setting.
- **DHCP Ping Timeout** — Enter the maximum time interval (in milliseconds) that the DHCP server waits for a ping reply. Use **Default** reverts to the default Ping Timeout.

Defining DHCP Server Using CLI Commands

The following table summarizes the CLI commands for defining the switch as a DHCP server.

Table 9-52. DHCP Server CLI Commands

CLI Command	Description
<code>ip dhcp server</code>	Enables the DHCP server feature on the device.
<code>no ip dhcp server</code>	Use the no form of this command to disable the DHCP server feature.
<code>ip dhcp ping enable</code>	Enables the DHCP server to send ping packets before assigning the address to a requesting client.
<code>no ip dhcp ping enable</code>	Use the no form of this command to prevent the server from pinging pool addresses.
<code>ip dhcp ping count number</code>	Specifies the number of packets a DHCP server sends to a pool address as part of a ping operation.
<code>no ip dhcp ping count</code>	Use the no form of this command to restore the default configuration.

Table 9-52. DHCP Server CLI Commands (Continued)

CLI Command	Description
ip dhcp ping timeout <i>milliseconds</i>	Specifies the time interval during which a DHCP server waits for a ping reply from an address pool.
no ip dhcp ping timeout	Use the no form of this command to restore default values.

The following is an example of the CLI commands:

```
console(config)# ip dhcp ping enable  
console(config)# ip dhcp ping count 5
```

Network Pool

When the device is serving as a DHCP server, a pool of IP addresses must be defined, from which the switch will allocate IP addresses to clients.

Each IP pool has a lease duration.

To create a pool of IP addresses, and define their lease durations:

- 1 Click **System > DHCP Server > Network Pool** in the tree view to display the **Network Pool: Summary** page.

Figure 9-43. Network Pool: Summary

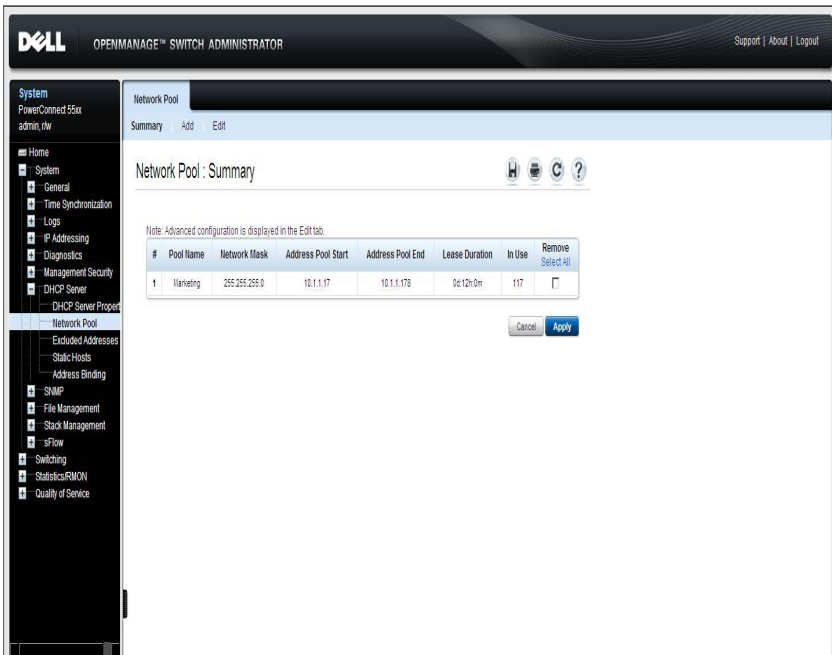

The previously-defined network pools are displayed.

- 2 Click **Add** to define a new network pool, and enter the fields:
 - **Pool Name** — Enter the pool name.
 - **Subnet IP Address** — Enter the subnet in which the network pool resides.

- **Network Mask** — Check and enter the pool's network mask.
 - **Prefix Length** — Check and enter the number of bits that comprise the address prefix.
- **Address Pool Start** — Enter the first IP address in the range of the network pool.
 - **Address Pool End** — Enter the last IP address in the range of the network pool.
 - **Lease Duration** — Enter the amount of time a DHCP client can use an IP address from this pool. The total lease duration is 4294967295 seconds, i.e. 49710.2696 days. Thus a lease of 49710 days, 0 hours, 0 minutes and 0 seconds is a legal value, while a lease of 49710 days, 23 hours, 59 minutes and 59 seconds results in an Out of Range alert.
 - **Days** — The duration of the lease in number of days. The range is 0 to 49710 days.
 - **Hours** — The number of hours in the lease. A days value must be supplied before an hours value can be added.
 - **Minutes** — The number of minutes in the lease. A days value and an hours value must be added before a minutes value can be added.
 - **Infinite** — The duration of the lease is unlimited.
 - **Default Router** — Enter the default router for the DHCP client.
 - **Domain Name Server** — Enter the DNS server available to the DHCP client.
 - **Domain Name** — Enter the domain name for a DHCP client. The domain name may contain up to 32 characters.
 - **NetBIOS WINS Server** — Enter the NetBIOS WINS name server available to a DHCP client.
 - **NetBIOS Node Type** — Select how to resolve the NetBIOS name. Valid node types are:
 - **Empty** — Default value.
 - **Broadcast** — IP Broadcast messages are used to register and resolve NetBIOS names to IP addresses.

- **Peer-to-Peer** — Point-to-point communications with a NetBIOS name server are used to register and resolve computer names to IP addresses.
 - **Mixed** — A combination of b-node and p-node communications is used to register and resolve NetBIOS names. M-node first uses b-node; then, if necessary, p-node. M-node is typically not the best choice for larger networks because its preference for b-node Broadcasts increases network traffic.
 - **Hybrid** — A hybrid combination of b-node and p-node is used. When configured to use h-node, a computer always tries p-node first and uses b-node only if p-node fails. This is the default.
- **SNTP Server** — Enter the IP address of the time server for the DHCP client.
 - **Next Server** — Enter the IP address of the next server in the boot process of a DHCP client. If the next server in the boot process is not configured, the DHCP server uses inbound interface helper addresses as boot servers.
 - **Next Server Name** — Enter the name of the next server in the boot process.
 - **Image File Name** — Enter the name of the file that is used as a boot image.

Configuring Network Pool Using CLI Commands

The following table summarizes the CLI commands for defining a pool of addresses on the DHCP server.

Table 9-53. Network Pool CLI Commands

CLI Command	Description
<code>ip dhcp pool network name</code>	Configures a DHCP address pool on a DHCP Server and enters DHCP Pool Configuration mode.
<code>no ip dhcp pool network name</code>	Use the no form of this command to remove the address pool.

Table 9-53. Network Pool CLI Commands (Continued)

CLI Command	Description
address { <i>network-number</i> low <i>low-address</i> high <i>high-address</i> } { <i>mask</i> <i>prefix-length</i> }	Configures the subnet number, mask and start and end addresses for a DHCP address pool on a DHCP Server. Use the no form of this command to remove the subnet number and mask.
no address	
lease { <i>days</i> [{ <i>hours</i> <i>minutes</i>]} infinite }	Configures the time duration of the lease for an IP address that is assigned from a DHCP server to a DHCP client.
no lease	Use the no form of this command to restore the default value
default-router <i>ip-address</i> [<i>ip-address2</i> ... <i>ip-address8</i>]	Configures the default router list for a DHCP client.
no default-router	Use the no form of this command to remove the default router list.
dns-server <i>ip-address</i> [<i>ip-address2</i> ... <i>ip-address8</i>]	Configures the DNS IP servers available to a DHCP client.
no dns-server	Use the no form of this command to remove the DNS server list.
domain-name <i>domain</i>	Specifies the domain name for a DHCP client.
no domain-name	Use the no form of this command to remove the domain name.
netbios-name-server <i>ip-address</i> [<i>ip-address2</i> ... <i>ip-address8</i>]	Configures the NetBIOS Windows Internet Naming Service (WINS) servers that are available to Microsoft DHCP clients.
no netbios-name-server	Use the no form of this command to remove the NetBIOS name server list.
netbios-node-type { <i>b-node</i> <i>p-node</i> <i>m-node</i> <i>h-node</i> }	Configures the NetBIOS node type for Microsoft Dynamic Host Configuration Protocol (DHCP) clients.
no netbios-node-type	Use the no form of this command to remove the NetBIOS node type.

Table 9-53. Network Pool CLI Commands (Continued)

CLI Command	Description
time-server <i>ip-address</i> [<i>ip-address2</i> ... <i>ip-address8</i>]	Specifies the time servers list for a DHCP client.
no time-server	Use the no form of this command to remove the time servers list.
next-server <i>ip-address</i>	Configures the next server in the boot process of a DHCP client.
no next-server	Use the no form of this command to remove the boot server.
next-server-name <i>name</i>	Configures the next server name in the boot process of a DHCP client.
no next-server-name	Use the no form of this command to remove the boot server name.
bootfile <i>filename</i>	Specifies the default boot image file name for a DHCP client.
no bootfile	Use the no form of this command to delete the boot image file name.
show ip dhcp pool network [<i>name</i>]	Displays the DHCP network pool configuration.

The following is an example of the CLI commands:

```
console(config)# ip dhcp pool network pool1
console(config-dhcp)# address 10.12.1.99 255.255.255.0
01b7.0813.8811.66
console(config-dhcp)# lease 1
```

Excluded Addresses

By default, the DHCP server assumes that all pool addresses in a pool may be assigned to clients. A single IP address or a range of IP addresses can be excluded.

To define an excluded address range:

- 1 Click **System > DHCP Server > Excluded Addresses** in the tree view to display the **Excluded Addresses: Summary** page.

Figure 9-44. Excluded Addresses: Summary

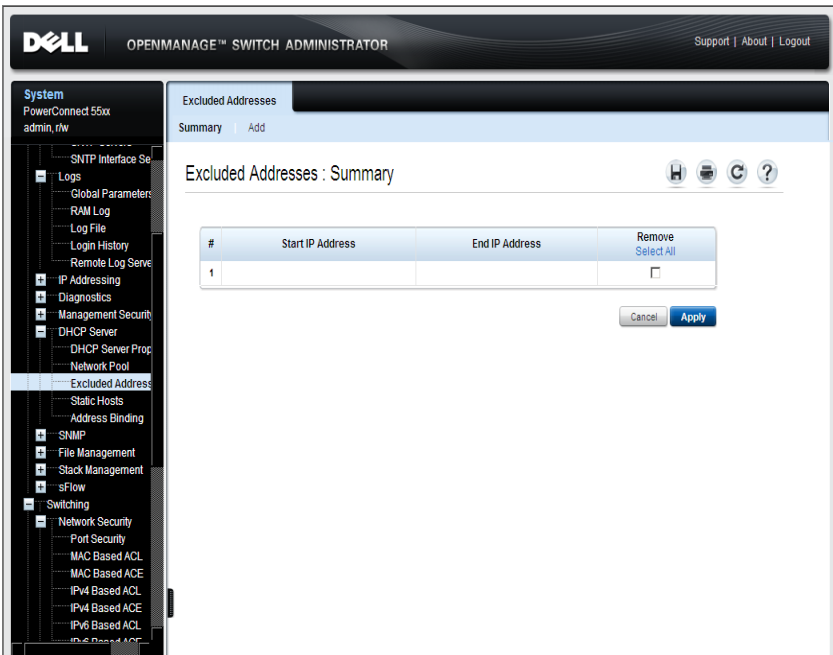

The previously-defined excluded IP addresses are displayed.

- 2 To add a range of IP addresses to be excluded, click **Add**, and enter the fields:
 - **Start IP Address** — First IP address in the range of excluded IP addresses.

- **End IP Address** — Last IP address in the range of excluded IP addresses.

Excluding Addresses Using CLI Commands

The following table summarizes the CLI commands for excluding addresses.

Table 9-54. Excluding Addresses Using CLI Commands

CLI Command	Description
ip dhcp excluded-address <i>low-address</i> [<i>high-address</i>]	Configures a DHCP address pool on a DHCP Server and enter DHCP Pool Configuration mode.
no ip dhcp excluded-address <i>low-address</i> [<i>high-address</i>]	Use the no form of this command to remove the address pool.
show ip dhcp excluded-addresses	Displays the excluded addresses.

The following is an example of the CLI commands:

```

console(config)# ip dhcp excluded-address 172.16.1.100
172.16.1.199
console> show ip dhcp excluded-addresses
The number of excluded addresses ranges is 2
Excluded addresses:
10.1.1.212- 10.1.1.219, 10.1.2.212- 10.1.2.219

```

Static Hosts

To manually allocate permanent IP addresses to clients (known as static hosts):

- 1 Click **System > DHCP Server > Static Hosts** in the tree view to display the **Static Hosts: Summary** page.

Figure 9-45. Static Hosts: Summary

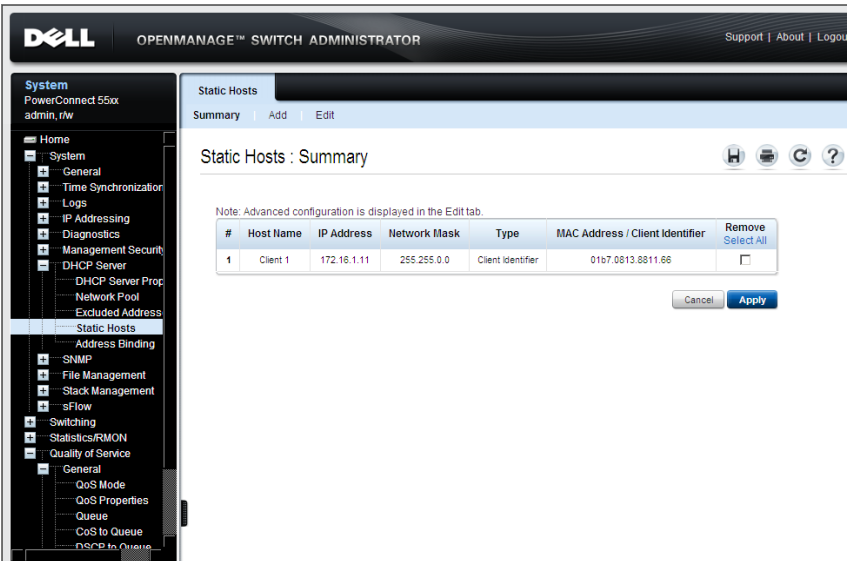

The static hosts are displayed.

- 2 To add a static host, click **Add**, and enter the fields:
 - **Host Name** — Enter the host pool name, which can be a string of symbols and an integer.
 - **IP Address** — Enter the IP address that was statically assigned to the host.
 - **Network Mask** — Enter the pool’s network mask.
 - **Prefix Length** — Enter the number of bits that comprise the address prefix.

- **Client Identifier** — Enter a unique identification of the client specified in dotted hexadecimal notation, such as: 01b6.0819.6811.72.
or:
- **MAC Address** — Enter the MAC address of DHCP static host.
- **Client Name** — The name of the client, using a standard set of ASCII characters. The client name must not include the domain name.
- **Default Router** — Enter the default router for the DHCP client.
- **Domain Name Server** — Enter the DNS server available to the DHCP client.
- **Domain Name** — Enter the domain name for a DHCP client. The domain name may contain up to 32 characters.
- **NetBIOS WINS Server** — Enter the NetBIOS WINS name server available to a DHCP client.
- **NetBIOS Node Type** — Select how to resolve the NetBIOS name. Valid node types are:
 - **Empty** — Default value.
 - **Broadcast** — IP Broadcast messages are used to register and resolve NetBIOS names to IP addresses.
 - **Peer-to-Peer** — Point-to-point communications with a NetBIOS name server are used to register and resolve computer names to IP addresses.
 - **Mixed** — A combination of b-node and p-node communications is used to register and resolve NetBIOS names. M-node first uses b-node; then, if necessary, p-node. M-node is typically not the best choice for larger networks because its preference for b-node Broadcasts increases network traffic.
 - **Hybrid** — A hybrid combination of b-node and p-node is used. When configured to use h-node, a computer always tries p-node first and uses b-node only if p-node fails. This is the default.
- **SNTP Server** — Enter the IP address of the time server for the DHCP client.

- **Next Server** — Enter the IP address of the next server in the boot process of a DHCP client. If the next server in the boot process is not configured, the DHCP server uses inbound interface helper addresses as boot servers.
- **Next Server Name** — Enter the name of the next server in the boot process.
- **Image File Name** — Enter the name of the file that is used as a boot image.

Defining Static Hosts Using CLI Commands

The following table summarizes the CLI commands for defining static hosts.

Table 9-55. Defining Static Hosts Using CLI Commands

CLI Command	Description
<code>ip dhcp pool host</code> <code>no ip dhcp pool host</code>	Configures a DHCP static address on a DHCP Server and enters the DHCP Pool Host Configuration mode. Use the no form of this command to remove the address pool.
<code>ip host name address [address2 address3 address4]</code> <code>no ip host name</code>	Defines the static host name-to-address mapping in the host cache. Use the no form of this command to remove the static hostname-to-address mapping.
<code>show hosts</code>	Displays the default domain name, the list of name server hosts, the static and the cached list of host names and addresses.
<code>clear host</code>	Deletes entries from the host name-to-address cache.

See Table 11-53 for the remaining CLI commands that are common to the **Network Pool** pages, but are used in the context DHCP Pool Host context.

The following is an example of the CLI commands:

```
console(config)# ip dhcp pool host station
console(config-dhcp)#ip host accounting.website.com
176.10.23.1
console# show hosts
System Name:
Default domain: Domain name is not configured
Name/address lookup is enable
Name servers (Preference order): 1.1.1.1 1.1.1.2 1.1.1.3
1.1.1.4 1.1.1.5
Configured host name-to-address mapping:
Host                                IP Address
-----
accounting.website.com              176.10.23.1
```

Address Binding

Use the **Address Binding** page to view and remove the IP addresses allocated by the switch and their corresponding MAC addresses.

To view and/or remove address bindings:

- Click **System > DHCP Server > Address Binding** in the tree view to display the **Address Binding** page.

Figure 9-46. Address Binding

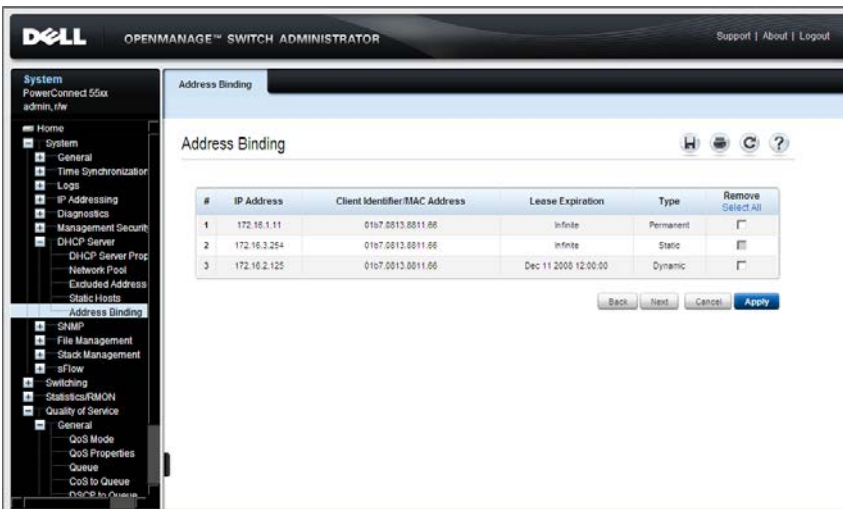

The following fields for the address bindings are displayed:

- **IP Address** — The IP addresses of the client.
- **Client Identifier/MAC Address** — A unique identification of the client specified as a MAC Address or in dotted hexadecimal notation, e.g., 01b6.0819.6811.72.
- **Lease Expiration** — The lease expiration date and time of the host's IP address.
- **Type** — The manner in which the IP address was assigned to the client. The possible options are:
 - **Static** — The hardware address of the host was mapped to an IP address.

- **Permanent** — The IP address, obtained dynamically from the switch, is owned by the client permanently (unless changes in the network environment/connections take place, for any reason).
- **Dynamic** — The IP address, obtained dynamically from the switch, is owned by the client for a specified period of time. The IP address is revoked at the end of this period, at which time the client must request another IP address.

SNMP

This section describes the Simple Network Management Protocol (SNMP) for managing network devices.

It contains the following topics:

- SNMP Overview
- SNMP Global Settings
- SNMP Views
- SNMP Access Control (Groups)
- SNMP User Security Model (Users)
- SNMP Communities
- SNMP Notification Filters
- SNMP Notification Recipients

SNMP Overview

The switch supports the SNMPv1, SNMPv2 and SNMPv3.

SNMP v1 and v2

The SNMP agent maintains a list of variables that are used to manage the switch. These variables are stored in the Management Information Base (MIB) from which they may be presented. The SNMP agent defines the MIB specification format, as well as the format used to access the information over the network. Access rights to the SNMP agents are controlled by access strings.

SNMPv1 and v2 are enabled by default.

SNMP v3

In addition to the features provided by SNMPv1 and SNMPv2, SNMPv3 applies access control and a new trap mechanism to SNMPv1 and SNMPv2 PDUs. In addition, a User Security Model (USM) can be defined, which includes:

- **Authentication** — Provides data integrity and data origin authentication.

- **Privacy** — Protects against disclosure of message content. Cipher Block-Chaining (CBC) is used for encryption. Either authentication alone can be enabled on an SNMP message, or both authentication and privacy can be enabled on an SNMP message. However privacy cannot be enabled without authentication.
- **Timeliness** — Protects against message delay or message redundancy. The SNMP agent compares incoming message to the message time information.
- **Key Management** — Defines key generation, updates, and use.

The switch supports SNMP notification filters, based on Object IDs (OIDs), which are used by the system to manage switch features.

Authentication or Privacy Keys are modified in the **User Security Model (USM)**.

SNMPv3 can only be enabled if the Local Engine ID is enabled.

SNMP Access Rights

Access rights in SNMP are managed in the following ways:

- **SNMPv1 and SNMPv2** — Communities

The community name is a password sent by the SNMP management station to the device for authentication purposes.

A community string is transmitted along with the SNMPv1,v2 frames, but neither the frames nor the community string are encrypted. Since SNMPv1 and SNMPv2 are not encrypted, they are not secure.

Communities can be associated with views or groups, and they are defined in the **Community** pages.

- **SNMPv3** — Users and Groups

SNMP v3 works with users instead of communities. The users belong to groups that have access rights assigned to them. Users are defined in the **User Security Model** pages

SNMPv3 provides two security mechanisms:

- **Authentication** — The switch checks that the SNMP user is an authorized system administrator. This is done for each and every frame.

- **Privacy** — SNMP frames can carry encrypted data.

These mechanisms can be combined to provide three levels of security:

- No security
- Authentication
- Authentication and Privacy. Note that for both authentication and privacy to be enabled, two groups with the same name, one with authentication and one with privacy, must be created.

A group is a label for a combination of attributes that determines whether members have read, write, and/or notify privileges. Users can be associated with a group. A group is operational only when it is associated with an SNMP user.

Model OIDs

The following are the switch model Object IDs (OIDs):

Model Name	Object ID
PC5524	10895.3030
PC5524P	10895.3032
PC5548	10895.3031
PC5548P	10895.3033

SNMP Global Settings

The Engine ID is used by SNMPv3 entities to uniquely identify themselves. An SNMP agent is considered an authoritative SNMP engine. This means that the agent responds to incoming messages (Get, GetNext, GetBulk, Set), and sends Trap messages to a manager. The agent's local information is encapsulated in fields in the message.

Each SNMP agent maintains local information that is used in SNMPv3 message exchanges (not relevant for SNMPv1 or SNMPv2). The default SNMP Engine ID is comprised of the enterprise number and the default MAC address. The SNMP engine ID must be unique for the administrative domain, so that no two devices in a network have the same engine ID.

The local information is stored in four read-only MIB variables: snmpEngineId, snmpEngineBoots, snmpEngineTime, and snmpEngineMaxMessageSize.

To configure SNMP:

- 1 Click **System > SNMP > Global Parameters** in the tree view to display the **Global Parameters** page.

Figure 9-47. Global Parameters

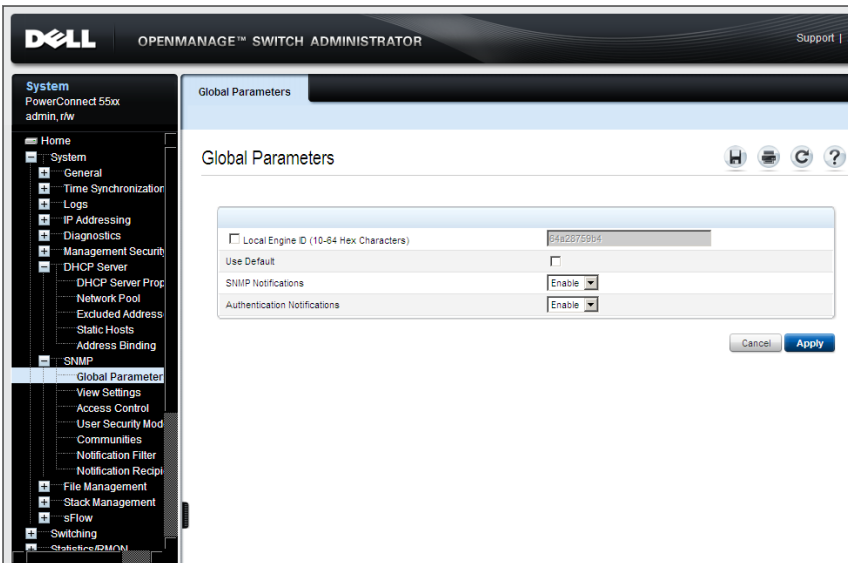

The global parameters are displayed.

- 2 Enter the fields:
 - **Local Engine ID (10-64 Hex Characters)** — Check and enter the local device engine ID. The field value is a hexadecimal string. Each byte in hexadecimal character strings is two hexadecimal digits. Each byte can be separated by a period or a colon. The Engine ID must be defined before SNMPv3 is enabled.

For stacked devices, verify that the Engine ID is unique for the administrative domain. This prevents two devices in a network from having the same Engine ID.

- **Use Default** — Check to use the device-generated Engine ID. The default Engine ID is based on the device MAC address, and is defined per standard as:
 - **First 4 octets** — First bit = 1, the rest is IANA Enterprise number = 674.
 - **Fifth octet** — Set to 3 to indicate the MAC address that follows.
 - **Last 6 octets** — MAC address of the device.
- **SNMP Notifications** — Enable/disable the switch sending SNMP notifications.
- **Authentication Notifications** — Enable/disable the switch sending SNMP traps when authentication fails.

Setting SNMP Global Parameters Using CLI Commands

The following table summarizes the CLI commands for setting fields in the Global Parameters page.

Table 9-56. SNMP Global Parameters Commands

CLI Command	Description
<code>snmp-server engine ID local {engine-id-string default}</code>	Specifies the local device engine ID. The field values is a hexadecimal string. Each byte in hexadecimal character strings is two hexadecimal digits. Each byte can be separated by a period or colon. The Engine ID must be defined before SNMPv3 is enabled.
<code>no snmp-server engine ID local</code>	Use the no form of this command to remove the configured engine ID.
<code>snmp-server enable traps</code>	Enables the router to send Simple Network Management Protocol traps.
<code>no snmp-server enable traps</code>	Use the no form of the command to disable SNMP traps.

Table 9-56. SNMP Global Parameters Commands (Continued)

CLI Command	Description
<code>snmp-server trap authentication</code>	Enables the router to send Simple Network Management Protocol traps when authentication fails.
<code>no snmp-server trap authentication</code>	Use the no form of this command to disable SNMP failed authentication traps.
<code>show snmp</code>	Checks the status of SNMP communications.

The following is an example of the CLI commands:

```
console(config)# snmp-server enable traps
console(config)# snmp-server trap authentication
console(config)# snmp-server engineid local default
The engine-id must be unique within your administrative domain.
Do you wish to continue? [Y/N]y
The SNMPv3 database will be erased. Do you wish to continue? [Y/N]y
```

SNMP Views

An SNMP view, which is a collection of MIB subtrees, provides or blocks access to device features.

Each subtree is defined by the Object ID (OID) of the root of its subtrees. In extreme cases this subtree can be a leaf. Well-known names can be used to specify the root of the desired subtree, or an OID can be entered (see "Model OIDs" on page 309).

Each subtree is either included in or excluded from the view being defined.

Views can be attached to groups in the **Access Control** pages.

To create an SNMP view:

- 1 Click **System > SNMP > View Settings** in the tree view to display the **View Settings: Summary** page.

Figure 9-48. View Setting: Summary

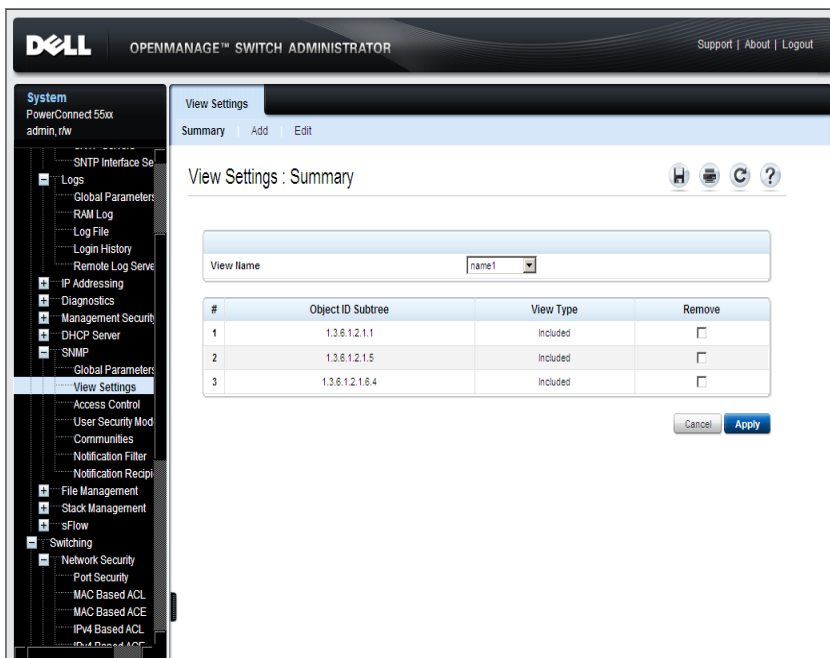

- 2 Select a view name. Its subtrees are displayed.
- 3 To remove a subtree from an SNMP view, click **Remove**. The subtrees of the default views (Default, DefaultSuper) cannot be changed.
- 4 To add a new view, click **Add**, and enter a new **View Name (1-30 Characters)**.
- 5 To complete the definition of the view, click **Edit**, and select a **View Name** to modify. Enter the fields:
 - **New Object ID Subtree** — Check to specify the device feature OID included or excluded in the selected SNMP view.

- **Selected from List** — Select the device feature OID by using the **Up** and **Down** buttons to scroll through a list of all device OIDs.

Or:

- **Insert** — Specify the device feature OID.
- **View Type** — Specify if the defined OID branch will be included or excluded in the selected SNMP view.

Defining SNMP Views Using CLI Commands

The following table summarizes the CLI commands for defining fields displayed in the **View Settings** pages.

Table 9-57. SNMP View CLI Commands

CLI Command	Description
<code>snmp-server view view-name oid-tree {included excluded}</code>	Creates or updates a SNMP server view entry.
<code>no snmp-server view view-name [oid-tree]</code>	Use the no form of this command to remove an SNMP server view entry.
<code>show snmp views [viewname]</code>	Displays the configuration of a view or all views.

The following is an example of CLI commands:

```

console(config)# snmp-server view user1 1 included
console(config)# end
console# show snmp views
Name                OID Tree            Type
-----            -
user1               system              included
Default             iso                  included
Default             snmpVacmMIB        excluded
Default             usmUser             excluded
Default             rndCommunityTable  excluded
DefaultSuper       iso                  included

```

SNMP Access Control (Groups)

For ease of use, users may be assigned to groups. In this way, it is possible to assign feature access rights to an entire group, instead of assigning them individually to users. Users are created in the **User Security Model** pages.

Groups can be defined in any version of SNMP, but only SNMPv3 groups can be assigned authentication methods.

To add an SNMP group, and assign it access control privileges:

- 1 Click **System > SNMP > Access Control** in the tree view to display the **Access Control: Summary** page.

Figure 9-49. Access Control: Summary

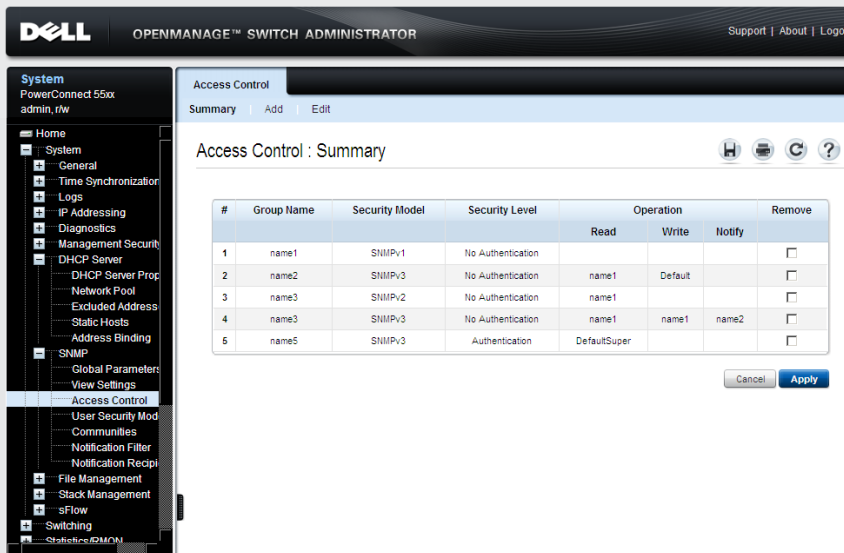

The screenshot shows the Dell OpenManage Switch Administrator interface. The left sidebar contains a navigation tree with categories like System, DHCP Server, and Switching. The main content area is titled "Access Control: Summary" and contains a table of existing groups. The table has columns for Group Name, Security Model, Security Level, Operation (Read, Write, Notify), and Remove. There are five rows of data in the table. Below the table are "Cancel" and "Apply" buttons.

#	Group Name	Security Model	Security Level	Operation			Remove
				Read	Write	Notify	
1	name1	SNMPv1	No Authentication				<input type="checkbox"/>
2	name2	SNMPv3	No Authentication	name1	Default		<input type="checkbox"/>
3	name3	SNMPv2	No Authentication	name1			<input type="checkbox"/>
4	name3	SNMPv3	No Authentication	name1	name1	name2	<input type="checkbox"/>
5	name5	SNMPv3	Authentication	DefaultSuper			<input type="checkbox"/>

Previously-defined groups are displayed.

- 2 To add a new group, click **Add**, and enter the fields:
 - **Group Name (1-30 Characters)** — Enter a group name.

- **Security Model** — Select the SNMP version of the group.
- **Security Level** — Select the security level attached to the group. Security levels apply to SNMPv3 only. The possible options are:
 - **No Authentication** — Neither authentication nor the privacy security levels are assigned to the group.
 - **Authentication** — Authenticates SNMP messages, and ensures that the origin of the SNMP message is authenticated.
 - **Privacy** — Encrypts SNMP message.
- **Operation** — Select the group access rights. The possible options are:
 - **Read** — The management access is restricted to read-only, and changes cannot be made to the assigned SNMP view. If desired, select a view from the drop-down list.
 - **Write** — The management access is read-write and changes can be made to the assigned SNMP view. If desired, select a view from the drop-down list.
 - **Notify** — Sends traps for the assigned SNMP view. If desired, select a view from the drop-down list.

Defining SNMP Access Control Using CLI Commands

The following table summarizes the CLI commands for defining fields displayed in the **Access Control** pages.

Table 9-58. SNMP Access Control CLI Commands

CLI Command	Description
<code>snmp-server group <i>groupname</i> {v1 v2 v3 {noauth auth priv}} [read <i>readview</i>] [write <i>writeview</i>] [notify <i>notifyview</i>]</code>	Configure a new Simple Network Management Protocol (SNMP) group, or a table that maps SNMP users to SNMP views.
<code>no snmp-server group <i>groupname</i> {v1 v2 v3 [noauth auth priv]} [<i>context-name</i>]</code>	Use the no form of this command to remove a specified SNMP group.
<code>show snmp groups [<i>groupname</i>]</code>	Displays the configuration of groups

The following is an example of the CLI commands:

```
console (config)# snmp-server group user-group v3 priv
read user-view
console# show snmp groups
```

Name	Security		Views		
	Model	Level	Read	Write	Notify
1	V1	noauth	-	-	-
2	V1	noauth	-	-	-
3	V1	noauth	-	-	-
4	V1	noauth	-	-	-
5	V1	noauth	-	-	-

SNMP User Security Model (Users)

An SNMP user is defined by the following:

- Login credentials (username, password, and authentication method)
- Context and scope in which the user operates
- Association with a group
- Engine ID

SNMP user login credentials are verified using a local database.

After a user is authenticated, it takes on the attributes of its group, and can then access the views permitted to this group. A user can only be a member of a single group.

Before you create an SNMPv3 user, create an SNMPv3 group in the **Access Control** pages.

When the configuration file is saved, SNMP communities/users are not saved. This means that if you configure another device with this configuration file, you must define the SNMP communities/users on that device.

To create an SNMP V3 user, and assign it to a group and view:

- 1 Click **System > SNMP > User Security Model** in the tree view to display the **User Security Model: Summary** page.

Figure 9-50. User Security Model: Summary

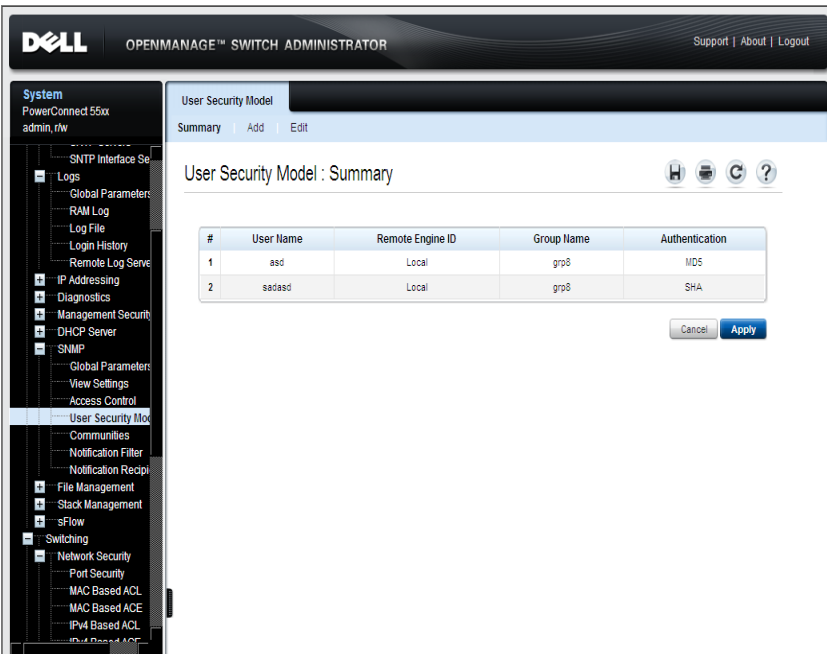

The currently-defined users and their groups are displayed.

- 2 To add a user, click **Add**, and enter the fields:
 - **User Name** (1-30 Characters) — Enter a new user name.
 - **Engine ID** — Specifies the local or remote SNMP entity, to which the user is connected. Changing or removing the local SNMP Engine ID deletes the SNMPv3 User Database. Select either **Local** or **Remote**. If **Remote** is selected, enter the remote engine ID.
 - **Group Name** — Select from a list of user-defined SNMP groups. SNMP groups are defined in the **Access Control Group** pages.

- **Authentication Method** — Select an authentication method used to authenticate users. The possible options are:
 - **None** — No user authentication is used.
 - **MD5 Password** — HMAC-MD5-96 password is used for authentication.
 - **SHA Password** — Users are authenticated using the HMAC-SHA-96 authentication level.
 - **MD5 Key** — Users are authenticated using the HMAC-MD5 algorithm.
 - **SHA Key** — Users are authenticated using the HMAC-SHA-96 authentication level.
- **Password (0-32 Characters)** — If the MD5 Password or SHA Password authentication method was selected, enter the user-defined password for a group.
- **Authentication Key (MD5-16; SHA-20 Hex Characters)** — If the MD5 Key or SHA Key authentication method was selected, enter the HMAC-MD5-96 or HMAC-SHA-96 keys. The authentication and privacy keys are entered to define the authentication key. If only authentication is required, 16 bytes are defined for MD5. If both privacy and authentication are required, 32 bytes are defined for MD5. Each byte in hexadecimal character strings is two hexadecimal digits. Each byte can be separated by a period or a colon.
- **Privacy Key (16 Hex Characters)** — If the MD5 Key or SHA Key authentication method was selected, enter the privacy key. If only authentication is required, 20 bytes are defined. If both privacy and authentication are required, 16 bytes are defined. Each byte in hexadecimal character strings is two hexadecimal digits. Each byte can be separated by a period or colon.

Defining SNMPv3 Users Using CLI Commands

The following table summarizes the CLI commands for defining fields displayed in the **User Security Model** pages.

Table 9-59. SNMP Users CLI Commands

CLI Command	Description
<code>snmp-server user username groupname {v1 v2c [remote-host] v3 [encrypted] [auth {md5 sha} auth-password]}</code>	Configures a new SNMP V3 user.
<code>no snmp-server user username [remote-host]</code>	Use the no form of the command to remove a user.
<code>show snmp users [username]</code>	Displays the configuration of users.

The following is an example of the CLI commands:

```
console(config)# snmp-server user tom acbd v1
console(config)# snmp-server user tom acbd v2c
console(config)# snmp-server user tom acbd v3
```

SNMP Communities

When using SNMP v1,2, communities strings (passwords) are used to provide access rights in the following ways:

- **Basic Table** — The access rights of a community can be read-only, read-write, or SNMP Admin. In addition, you can restrict access to the community to only certain MIB objects using a **view**. Views are defined in the **Views Setting** pages.
- **Advanced Table** — Access rights to a community are assigned to a group that consists of users. A group can have Read, Write, and Notify access to views. Groups are defined in the **Access Control** pages.

To define an SNMP community:

- 1 Click **System > SNMP > Communities** in the tree view to display the **Communities: Summary** page.

Figure 9-51. SNMP Community

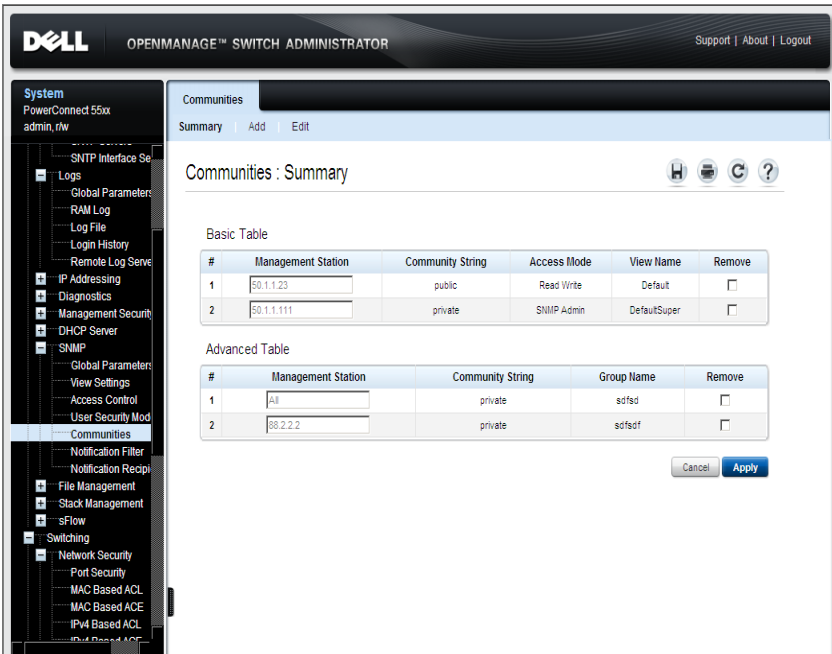

The Basic and Advanced tables are displayed.

- 2 To add a new community, click **Add**.
- 3 Define the SNMP management station by entering its IP address information:
 - **Supported IP Format** — Select whether the IPv4 or IPv6 format is being used.
 - **IPv6 Address Type** — When the community supports IPv6, this specifies the type of static address supported. The possible options are:
 - **Link Local** — A Link Local address that is non-routable and used for communication on the same network only.

- **Global** — A globally unique IPv6 address; visible and reachable from different subnets.
 - **Link Local Interface** — When the server supports an IPv6 Link Local address, this specifies the Link Local interface. The possible options are:
 - **VLAN** — The VLAN on which the IPv6 interface is configured.
 - **ISATAP** — The IPv6 interface is configured on an ISATAP tunnel.
 - **SNMP Management Station** — Enter the management station IP address for which the SNMP community is defined, or choose **All** to be able to receive SNMP messages from anywhere.
 - **Community String (1-20 Characters)** — Enter the community string, which functions as a password, and is used to authenticate the management station to the device.
- 4** To associate access mode and views directly with the community, enter the fields:
- **Basic** — Check to enable SNMP Basic mode for a selected community.
 - **Access Mode** — If Basic is selected, specify the access rights of the community. The possible options are:
 - **Read-Only** — Management access is restricted to read-only, and changes cannot be made to the community.
 - **Read-Write** — Management access is read-write and changes can be made to the device configuration, but not to the community.
 - **SNMP Admin** — User has access to all device configuration options, as well as permissions to modify the community.
 - **View Name** — Select a view from a list of user-defined SNMP views. The view determines other characteristics associated with the community.
- 5** To use Advanced mode, enter the fields:
- **Advanced** — When SNMP Advanced mode is selected, you can select an SNMP group to specify the SNMP access control rules for the selected community. The SNMP Advanced mode is defined only with SNMPv3.

- **Group Name** — Select the group to be associated with the community.

Configuring Communities Using CLI Commands

The following table summarizes the CLI commands for setting fields in the Community pages.

Table 9-60. SNMP Community CLI Commands

CLI Command	Description
snmp-server community <i>community</i> [view <i>view-name</i>] [ro rw su] { <i>ipv4-address</i> <i>ipv6-address</i> } [mask <i>mask-value</i> prefix-length <i>prefix-value</i>] [type <i>router</i> <i>oob</i>]	Sets up the community access string to permit access to the SNMP protocol. Use the no form of this command to remove the specified community string
snmp-server community-group <i>community group-name</i> [<i>ipv4-address</i> <i>ipv6-address</i>][mask prefix-length] [type <i>router</i> <i>oob</i>]	Sets up community access string to permit limited access to the SNMP protocol, based on group access rights.
no snmp-server community string [<i>ipv4-address</i> <i>ipv6-address</i>]	
show snmp	Displays the current SNMP device configuration.

The following is an example of the CLI commands:

```
console (config)# snmp-server community dell ro 10.1.1.1
```

SNMP Notification Filters

Notification filters determine the type of SNMP notifications that are sent to the management station, based on the OID of the notification to be sent. Each OID is linked to a device feature or a feature aspect.

SNMP notification filters provide the following services:

- Identification of management trap targets
- Trap filtering

- Selection of trap generation parameters
- Access control checks

After creating a notification filter, attach it to a notification recipient in the **SNMPv1,2 Notification Recipients** pages.

To add a notification filter:

- 1 Click **System > SNMP > Notification Filters** in the tree view to display the **Notification Filter: Summary** page.

Figure 9-52. Notification Filter: Summary

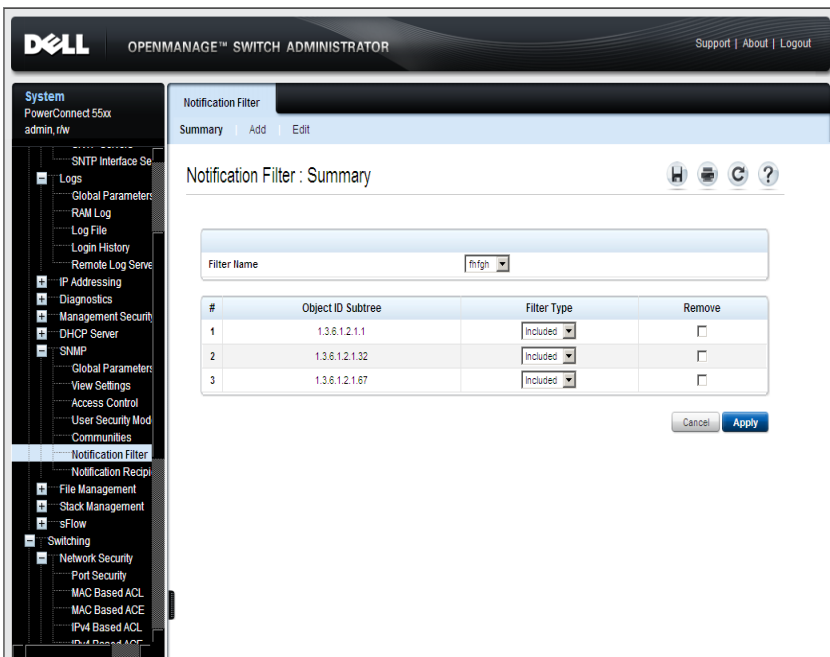

- 2 The OIDs of the selected filter are displayed.
- 3 If required, the notification filter type can be changed by selecting one of the following options:
 - **Excluded** — OID traps or informs will not be sent.
 - **Included** — OID traps or informs will be sent.

- 4 To add a new notification filter, click **Add**.
- 5 In addition to the fields described in the **Summary** page, enter the fields:
 - **Filter Name (1-30 Characters)** — Enter the notification filter name.
 - **New Object Identifier Tree** — Check to specify the device feature OID included or excluded in the selected SNMP view.
 - **Selected from List** — Select the device feature OID by using the **Up** and **Down** buttons to scroll through a list of all device OIDs.

or:

 - **Object ID** — Specify the device feature OID.- **Filter Type** — Select whether the defined OID branch will be **Included** or **Excluded** in the selected SNMP view.

Configuring Notification Filters Using CLI Commands

The following table summarizes CLI commands for defining fields displayed in the **Notification Filter** pages.

Table 9-61. SNMP Notification Filter CLI Commands

CLI Command	Description
<code>snmp-server filter filter-name oid-tree {included excluded}</code>	Creates or updates an SNMP notification filter.
<code>no snmp-server filter filter-name [oid-tree]</code>	Use the no form of this command to remove the specified SNMP server filter entry.
<code>show snmp filters [filter-name]</code>	Displays the configuration of SNMP notification filters

The following is an example of CLI commands:

```
console (config)# snmp-server filter user1 iso included
console(config)# end
console # show snmp filters
```

Name	OID Tree	Type
-----	-----	-----
user1	iso	Included

SNMP Notification Recipients

An SNMP notification is a trap message, sent from the switch to the SNMP management station, indicating that a certain event has occurred, such as a link up or down.

Trap receivers, also known as notification recipients, are network nodes to which trap messages are sent by the switch.

A trap receiver entry contains the IP address of the node and the SNMP credentials corresponding to the version that will be included in the trap message. When an event arises that requires a trap message to be sent, it is sent to every node listed in the trap receiver list.

Some messages are of an informational nature and are called "informs" instead of traps.

To add notification recipients, and attach them to notification filters:

- 1 Click **System > SNMP > Notification Recipient** in the tree view to display the **Notification Recipients: Summary** page.

Figure 9-53. Notification Recipients: Summary

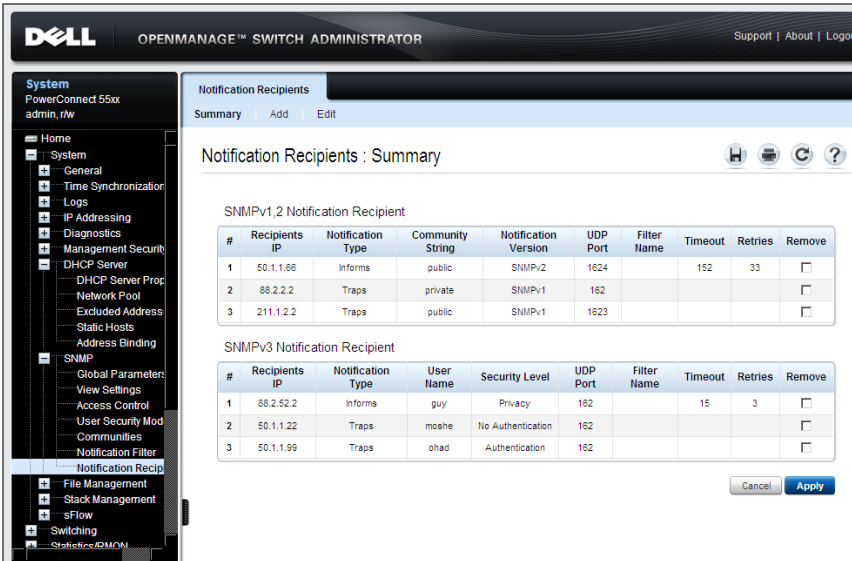

The previously-defined notification recipients are displayed.

- 2 To add a new notification recipient, click **Add**, and enter the fields:
 - **Supported IP Format** — Select whether the IPv4 or IPv6 format is supported.
 - **IPv6 Address Type** — When the recipient supports IPv6, this specifies the type of static address supported. The possible options are:
 - **Link Local** — A Link Local address that is non-routable and used for communication on the same network only.
 - **Global** — A globally unique IPv6 address; visible and reachable from different subnets.

- **Link Local Interface** — When the server supports an IPv6 Link Local address, this specifies the Link Local interface. The possible options are:
 - **VLAN** — The IPv6 interface is configured on this VLAN.
 - **ISATAP** — The IPv6 interface is configured on an ISATAP tunnel.
- **Recipient IP** — The IP address to whom the traps are sent.
- **Notification Type** — The notification sent. The possible options are:
 - **Trap** — Traps are sent.
 - **Inform** — Informs are sent.

If SNMP versions 1 and 2 are enabled for the selected recipient, enter the fields:

- **Community String** — The community string of the trap manager.
- **Notification Version** — The message trap SNMP version (v1 or v2).

If SNMPv3 is used to send and receive traps, enter the fields:

- **User Name** — The user to whom SNMP notifications are sent.
- **Security Level** — The means by which the packet is authenticated. The possible options are:
 - **No Authentication** — The packet is neither authenticated nor encrypted.
 - **Authentication** — The packet is authenticated.
 - **Privacy** — The packet is both authenticated and encrypted.

3 Enter the fields for all versions of SNMP:

- **UDP Port (1-65535)** — The UDP port used to send notifications. The default is 162.
- **Filter Name** — Select an SNMP filter from a list of previously-defined SNMP filters.
- **Timeout (1-300)** — The amount of time (seconds) the device waits before resending informs.
- **Retries (1-255)** — The amount of times the device resends an inform request.

Configuring SNMP Notification Recipients Using CLI Commands

The following table summarizes the CLI commands for setting fields in the Notification Recipients pages.

Table 9-62. SNMP Notification CLI Commands

CLI Command	Description
snmp-server host { <i>ipv4-address ipv6-address hostname</i> } [traps informs] [version { <i>1 2c 3</i> }] [auth noauth priv]] [community-string [udp-port <i>port</i>] [filter <i>filename</i>] [timeout <i>seconds</i>] [retries <i>retries</i>] no snmp-server host { <i>ipv4-address ipv6-address hostname</i> } [traps informs] [version { <i>1 2c 3</i> }] show snmp	Creates or updates a notification recipient receiving notifications in SNMP version 1, 2 or 3. Use the no form of this command to remove the specified host. Shows the current SNMP configuration.

The following is an example of the CLI commands:

```

console(config)# snmp-server host 172.16.1.1 private
console(config)# end
console# show snmp
Community-      Community-      View Name      IP Address
String          Access
-----
public         read only      user-view      All
private       read write     default        172.16.1.1
private       su             DefaultSup    172.17.1.1
er

```

File Management

This section describes how to manage device firmware (image files) and configuration files.

It contains the following topics:

- File Management Overview
- Auto-Update/Configuration Feature
- File Download
- File Upload
- Active Images
- Copy Files
- File System

File Management Overview

This section describes the system files found in the system and how they can be updated (downloaded) and backed up (uploaded).

System Files

The following system files are maintained on the system:

- **Startup Configuration File** — Files with extension `.text`. These files contain the commands required to configure the device at startup or after reboot. The Startup Configuration file is created from the Running Configuration file, or can be created from another file.
- **Running Configuration File** — Files with extension `.text`. These files contain all Startup Configuration file commands, as well as all commands entered during the current session. After the device is powered down or rebooted, all commands stored in the Running Configuration file are lost.

During the startup process, all commands in the Startup Configuration file are copied to the Running Configuration file, and applied to the device.

During the session, new configuration commands are added to the Running Configuration file. To update the Startup Configuration file with these configuration commands, the Running Configuration file must first be copied to the Startup Configuration file before powering down the

device. This can be done manually in the Copy Files page or see "Auto-Update/Configuration Feature" on page 331 for more information about how to perform this automatically.

- **Image Files**—Files with extension `.ros`. System file images are saved in two flash files called Image 1 and Image 2. The active image contains the active copy, while the other image contains a backup copy. The device boots and runs from the active image. If the active image is corrupted, the system automatically boots from the non-active image. This is a safety feature for faults occurring during the software upgrade process.

Downloading/Uploading System Files

System files can be manually loaded from (downloaded) or copied to (uploaded) a TFTP server or a USB drive. This can be done in one of the following ways:

- **Manually**—System files can be downloaded using the *File Download* page and uploaded using the *File Upload* page.
- **Automatically (Auto Update/Configuration)**—System files can be downloaded automatically, as follows:
 - **Auto-Configuration**—If the Auto-Configure feature is enabled (in the Auto Update of Configuration/Image File page), the Startup Configuration file (in various conditions described below) might be automatically updated after reboot.
 - **Auto-Update**—If the Firmware Auto-Update feature is enabled in the Auto Update of Configuration/Image File page, the image file is might be automatically updated (in various conditions described below).

Auto-Update/Configuration Feature

The Auto-Update/Configuration feature enables initial configuration of the device and upgrading of the firmware through an automatic process, which enables the administrator to ensure that the configuration/firmware of all the devices in the network is up-to-date.

The required configuration files/images are stored on a USB key or TFTP server, and these are downloaded to all the devices in the network when the device boots up instead of booting from a local startup configuration file.

Auto-Update/Configuration also enables quick installation of new devices on the network, since an out-of-box device can be configured to retrieve its configuration file from the network/USB, allowing instant access to it from the administrator's management station and up-to-date configuration on the device.

NOTE: If Auto-Update is performed through the USB port, in addition to upgrading the Startup Configuration and image file, a new IP address can also be assigned to the device. See "Setup Files" on page 332 below.

Setup Files

In addition to placing configuration and image files on the USB key, the USB key might also contain a setup file, which is a file with a `.setup` extension.

Setup File Contents

A setup file contains one or more lines. Each line contains some or all of the following fields:

- **MAC Address**—This indicates to which device the line applies. In this way, a single setup file can be used for multiple devices.
- **New IP Address**—The new IP address to be assigned to the device.
- **New IP Address Mask**—The IP address mask to be applied to the new IP address assigned to the device.
- **Configuration File Name**—Name of the configuration file to be used as the Startup Configuration.
- **Image File Name**—Name of the image file to be loaded on device.
- **Flag**—Indicates the status of the line. The following values can be used in this field:
 - **In-Use**—This line has already been applied. It is no longer a candidate for future use.
 - **Invalid**—The line is invalid, do not use.
 - **Blank**—There is no value for the flag field. This line is a candidate to be applied to the device.

Setup File Format

A line in a setup file contains all or some of the above fields separated by spaces (in the following order):

<MAC-Address> <New-IP-Address> <New-IP-Mask> <Configuration-File-Name> <Image-File-Name> <flag>

If the <flag> field is omitted, it is considered to be blank.

A line can be in one of the following formats:

- Format A—Contains all possible fields:

<MAC_address (of device)> <New_IP_Address> <New_IP_Mask>
<Configuration-File-Name> <Image-File-Name> <flag>

Examples:

- 0080.c200.0010 192.168.0.10 255.255.255.0 switch-X.text pc5500-4018.ros

This means that the line applies to the device with MAC address: **0080.c200.0010**; a new IP address of **192.168.0.10** is to be assigned to the device, with mask: **255.255.255.0**. The **switch-x.text** is the Startup Configuration file and **pc5500-4018.ros** is the new image file.

- 0080.c200.0010 192.168.0.10 255.255.255.0 switch-X.text pc5500-4018.ros in-use

This line will not be used because the flag is **in-use** indicating that it has already been used for some device, and it would be incorrect to use it for another device.

- 0080.c200.0010 192.168.0.10 255.255.255.0 switch-X.text pc5500-4018.ros invalid

This line will not be used because the flag is **invalid** indicating that it is failed in the past.

- Format B—Contains the following 4 fields:
<MAC_address> <Configuration-File-Name> <Image-File-Name>
<flag>

Example:

```
0080.c200.0010 switch-X.text pc5500-4018.ros
```

This means that the line applies to the device with MAC address: 0080.c200.0010. The **switch-x.text** is the Startup Configuration file and **pc5500-4018.ros** is the new image file.

- Format C—Contains the following 5 fields:
<IP_address> <IP_mask> <Configuration-File-Name> <Image-File-Name> <Flag>

Example:

```
192.168.0.10 255.255.255.0 switch.text pc5500-4018.ros
```

This means that the line applies to any device (no MAC address is supplied); a new IP address of 192.168.0.10 is to be assigned to the device, with mask: 255.255.255.0. The **switch-x.text** is the Startup Configuration file and **pc5500-4018.ros** is the new image file.

- Format D—Contains the following 3 fields:
<IP_address> <IP_mask> <Flag>

Example:

```
192.168.0.10 255.255.255.0
```

This means that the line applies to any device (no MAC address is supplied); a new IP address of 192.168.0.10 is to be assigned to the device, with mask: 255.255.255.0.

Triggering the Auto-Update/Configuration Process

When the Auto-Update/Configuration feature is enabled (in the Auto Update of Configuration/Image File page), the device automatically attempts to download a new image or configuration file (under certain circumstances) using one of the following processes:

- The Auto-Update process is triggered from the USB drive if a USB key in the USB drive is found.
- The Auto-Configuration process is triggered from the USB drive after the Auto-Update process completed and the device was rebooted (if a new image file was loaded), and if the following conditions are fulfilled:
 - There is a USB key in the USB drive.
 - Force Configuration Download at Next Startup has been enabled by the boot host dhcp command, or the Startup Configuration file is empty.

See "Performing Auto-Update from a USB Drive" on page 336.

- The Auto-Update from a TFTP server is triggered if the following conditions are fulfilled:
 - The conditions for a USB Auto-Update are not fulfilled.
 - An IP address of a TFTP server is received from a DHCP server.
 - A file name is received from DHCP server.
- The Auto-Configuration from a TFTP server is triggered if the following conditions are fulfilled:
 - The conditions for USB Auto-Configuration are not fulfilled.
 - The switch as DHCP client received a configuration file name or a TFTP URL.
 - Force Configuration Download at Next Startup enabled by the boot host dhcp command, or, the Startup Configuration file is empty.

See "Preparations for Using Auto Configuration from a TFTP Server" on page 338.

NOTES:

- DHCP client never triggers the Auto-Update process from a TFTP server after attempting (whether successfully or not) to auto-update/configure configuration/image file from the USB drive.

- If the auto process involved setting the IP address of the device from the setup file, the auto process from the TFTP server can be triggered.
- If the USB drive contains a setup file, but that setup file does not include a line that can be used for the current device, the DHCP client is able to trigger the Auto-Update process from TFTP (because the USB process never started at all).

Automatic DHCP IP Interface Assignment

The user can manually define a DHCP interface in the DHCP IPv4 page.

If the user does not do this, the switch automatically creates a DHCP interface on the VLAN with the lowest VLAN ID that does not have an IP address defined on it after boot if both of the following conditions are fulfilled:

- There is no DHCP IP interface.
- There is a VLAN without an IP address.

Preparations for Using Auto Update/Configuration from a USB Drive

Before Auto-Update/Configuration from a USB drive can be performed, the following steps must be performed:

1. Enable Auto-Update/Configuration in the Auto Update of Configuration/Image File page.
2. (Optional) Create a line in the setup file for this device containing the required options and load it on the USB key.
3. Load configuration/image files on the USB key as required.
4. Insert the USB key in the USB drive and reboot the device.

Performing Auto-Update from a USB Drive

When Auto-Update is initiated from a USB drive, the following steps are performed:

1. Locate the correct setup file—The USB drive is searched for a setup file. One of the following can occur:
 - Setup file is not found—The root folder of the USB is searched for an image files (with `.ros` extension).
 - The image file with the most recent version is loaded into the image file if the versions are different.

- If a new image file was loaded, the device is rebooted.
 - The USB drive is searched for a configuration file (.text extension). If there is more than one configuration file, the file named powerconnect.text is loaded (if it is not found the process is stopped).
- One or more setup files are found—If a single setup file is found, it is used; if several files are found, the file **powerconnect.setup** is used. If no setup file with this name is found, the process is stopped.
2. Find the line in the setup file relevant to the device—When the correct setup file is found, it is searched for a line relevant to the device, as follows:
 - The setup file is searched for a line with format A or B in which there is a match to the device's MAC address. If such line is found, and its format is valid (the <flag> field is empty), the line is applied.
 - If no line for the specific device was found, the setup file is searched for valid lines with formats C or D. The first line found is applied.
 3. Apply the correct line—When the correct line in the setup file is found, it is applied, as follows:
 - If the line contains an IP address and IP mask, the IP address is configured on the default VLAN.
 - If the line contains an image file and its version differs from the current image file version, the USB image file is loaded and the switch is rebooted.
 - If a new image file was loaded, it is loaded onto all units in the stack.
 - If the line contains a configuration file, the configuration file is appended to running configuration file.
 4. Mark the flag in the applied line—When the line is applied (successfully or not), its flag is set, as follows:
 - If the line contains an IP address and IP mask (format C or D), the IP address is configured on the default VLAN and the line is marked as "in-use". This ensures that the line is not used for another device.
 - If the line was not applied successfully, for one of the following reasons, the line is marked as "invalid" and a SYSLOG message is sent.

- The configuration file specified by the line does not exist on the USB key or is corrupted.
- The image file specified by the line does not exist on the USB key or is corrupted.
- If parsing of the line failed for some other reason, the line is ignored and a SYSLOG message is sent.

NOTE: When both Auto-Update and Auto-Configuration are performed, the image file is loaded first, the device is booted and then the configuration file is loaded.

Preparations for Using Auto Configuration from a TFTP Server

The **Auto-Update/Configuration** feature enables configuring the device from a configuration file found on the TFTP server.

Two methods may be used:

- One-file Read, described in "Auto Configuration (One File Read Method)" on page 338. This method is used if a configuration file is found on the TFTP server.
- Multi-file Read, described in "Auto Configuration (Multi File Read Method)" on page 339. This method is used if a configuration file name is not found on the DHCP server, or the configuration file is not found on the TFTP server.

Auto Configuration (One File Read Method)

This method requires the following preparations on the DHCP and TFTP servers:

- **TFTP Server**
Place a configuration file, for example **config.txt** in the main directory. This file can be created by copying a configuration file from a device. When the device is booted this becomes the Running configuration file.
- **DHCP Server**
 - Configure the DHCP server with option 67 and the name of the configuration file on the TFTP server (for example, **config.txt**).
 - Configure the DHCP server with option -20 or 66. This is the IP address of the TFTP server.

- **Device** - On the device, one of the following cases may exist:
 - If **Configuration Auto-Config** is selected, the device is configured with the configuration file on the TFTP server only if the Startup configuration file is empty.
 - If **Force Configuration Download at Next Startup** is selected, the device is configured with the configuration file on the TFTP server whether the Startup configuration file is not empty or not.

Auto Configuration (Multi File Read Method)

If the one-file method has failed and the TFTP Server IP address has been provided by the DHCP Server, the switch applies the multi-file method to download the configuration file. The following steps are performed by the switch:

- The switch gets the hostname, as described below.
 - If the hostname was provided by the DHCP server, this hostname is used.
 - If the hostname has not been provided by a DHCP server, and if the user has configured the `sysName` variable, its value is used as a hostname.
 - If neither of the above occurred, the switch uses the `fp-net.cfg` Filename List on the TFTP server. Each file in this list is a text file containing commands, each of which:
 - Occupies one line.
 - Has the following format: `ip host hostname ip-addr`. Each line maps an IP address to a hostname. When the switch identifies its own IP address in this list, the hostname associated with it is used.
- The switch tries to download a configuration file with the following names:
 - `hostname-config`
 - `hostname.cfg` if the previous file does not exist
 - `host.cfg` if the previous files do not exist

Preparations for Firmware Image Download from TFTP

The **image file download** consists of the following steps:

- The switch downloads the Indirect Image File and extracts from it the name of the image file.
Note: If the size of the image name bigger than 160 octets only the first 160 octets will be used
- If the image file version differs from the current image file version, then the image file is loaded and the switch is rebooted.

The preparations on the DHCP and TFTP servers require the following:

- **TFTP Server**
 - Create a sub directory in the main directory. Place a software image file in it.
 - Create an indirect file that contains a path and the name of the software version (for example indirect-contax.txt that contains contax\contax-version.ros).
 - Copy this file to the TFTP server's main directory
- **DHCP Server**
 - Configure the DHCP server with option -20 or 66. This is the IP address of the TFTP server.
 - Configure the DHCP server with option 125. Enter the following information:
 - A2-02-00-00 — Enterprise Number 674 (Dell PowerConnet 55xx value). It should be written from right to left. 674=02 a2
 - 15 — Data Length
 - 01 — Sub option code 1 (Dell PowerConnet 55xx value)
 - 13 — Sub option length
 - Conversion of the file name (in the above example: conversion of **indirect-contax.txt** from ASCII to HEX - 69-6E-64-69-72-65-63-74-2D-63-6F-6E-74-61-78-2E-74-78-74

Auto Update Configuration through the GUI

To set the auto update and configuration parameters:

-  **NOTE:** For the automatic options in this page to work the following must be implemented:
- Since Auto-Config depends on retrieving information from a DHCP server, the startup configuration needs to include a DHCP IP interface. The device is defined as a DHCP client, as described in "DHCP IPv4 Interface" on page 207. After reboot, this command is not saved in the Startup configuration.
 - Preparations described above must be completed on the DHCP server and TFTP servers.
- 1 Click System > File Management > Auto Update of Configuration/Image File in the tree view to display the Auto Update of Configuration/Image File page.

Figure 9-54. Auto Update of Configuration/Image File



The auto-update-configuration options are displayed.

- 2 Modify the auto-update configuration parameters as required:
 - **Configuration Auto-Config (boot host auto-config)**— Enable/disable automatic download of the configuration parameters to the Running Configuration file. By default, this occurs only if the Startup Configuration file is empty.
 - **Firmware Auto-Update (boot host auto-update)**— Enable/disable automatic download of the image file.
 - **Force Configuration Download at Next Startup (boot host dhcp)** — Enable/disable the **Configuration Auto Update** option to work even if the Startup Configuration file is not empty.
 - **Auto-Copy Running Configuration to Startup Configuration After Download (boot host auto-save)**— Enable/disable the Running Configuration file to be automatically copied to the Startup Configuration file after downloading the Running Configuration file.

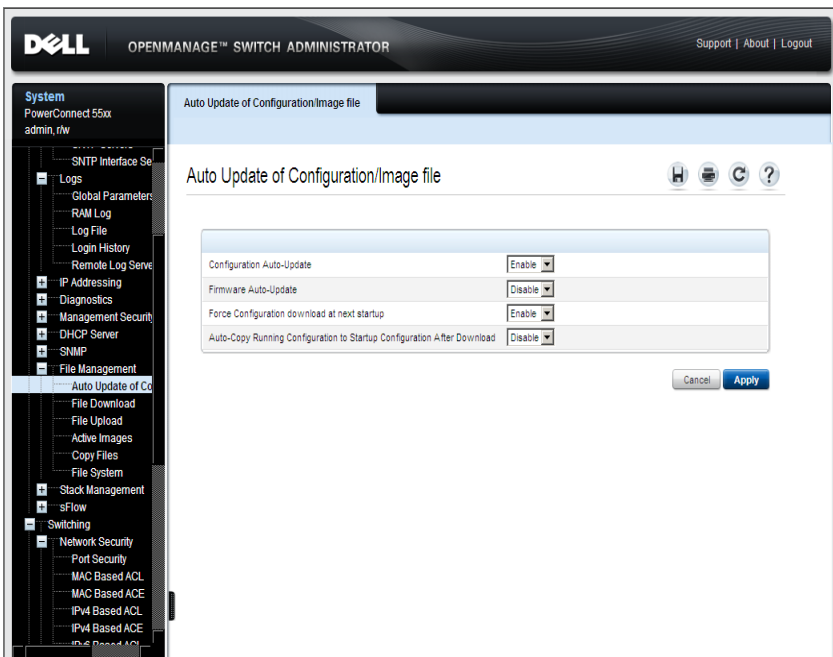
Auto Update Configuration Using CLI Commands

The following table summarizes the CLI commands for setting fields displayed in the **Auto Update of Configuration/Image File** page.

Table 9-63. Auto Update of Configuration/Image File CLI Commands

CLI Command	Description
<code>boot host auto-config</code>	Enables the support of auto-configuration via DHCP.
<code>no boot host auto-config</code>	Use the no form of this command to disable DHCP auto configuration.
<code>boot host auto-update</code>	Enables the support of auto-update via DHCP.
<code>no boot host auto-update</code>	Use the no form of this command to disable DHCP auto configuration

Table 9-63. Auto Update of Configuration/Image File CLI Commands (Continued)

CLI Command	Description
<code>boot host dhcp</code> <code>no boot host dhcp</code>	Forces the mechanism used to download a configuration file at the next system startup. Use the no form of this command to restore the host configuration file to the default.
<code>boot host auto-save</code> <code>no boot host auto-save</code>	Enables automatic saving of Running configuration in Startup configuration after download. Use the no form of this command restore default behavior
<code>show boot</code>	Shows the status of the IP DHCP Auto Config process.

The following is an example of the CLI command to view the Auto-Update status:

```
console# show boot
Auto Config
-----
Config Download via DHCP: enabled
Next Boot Config Download via DHCP: force
Auto Update
-----
Image Download via DHCP: enabled
```

The following is an example of the CLI command to configure auto-update on the switch:

```
console# configure
console(config)# boot host auto-save
console(config)# interface vlan 1
console(config-if)# ip address dhcp
console(config-if)# 01-Oct-2006 15:19:51 %BOOTP_DHCP_CL-W-
DHCPIPCCANDIDATE: The device is waiting for IP address
verification on interface Vlan 1 , IP 10.5.225.47, mask
255.255.255.224, DHCP server 10.5.224.25
01-Oct-2006 15:20:03 %BOOTP_DHCP_CL-I-DHCPCONFIGURED: The
device has been configured on interface Vlan 1 , IP
10.5.225.47, mask 255.255.255.224, DHCP server 10.5.224.25
01-Oct-2006 15:20:03 %COPY-I-FILECPY: Files Copy - source
URL tftp://10.5.224.4/33.txt destination URL running-
config
01-Oct-2006 15:20:03 %COPY-N-TRAP: The copy operation was
completed successfully
01-Oct-2006 15:20:03 %COPY-I-FILECPY: Files Copy - source
URL running-config destination URL flash://startup-config
01-Oct-2006 15:20:10 %COPY-N-TRAP: The copy operation was
completed successfully
```

File Download

Software and configuration files can be downloaded from an external device to the switch:

- To download from a USB port or when management computer uses HTTP
- To download files using TFTP

To download from a USB port or when management computer uses HTTP

- 1 Click System > File Management > File Download in the tree view to display the File Download page.

Figure 9-55. File Download

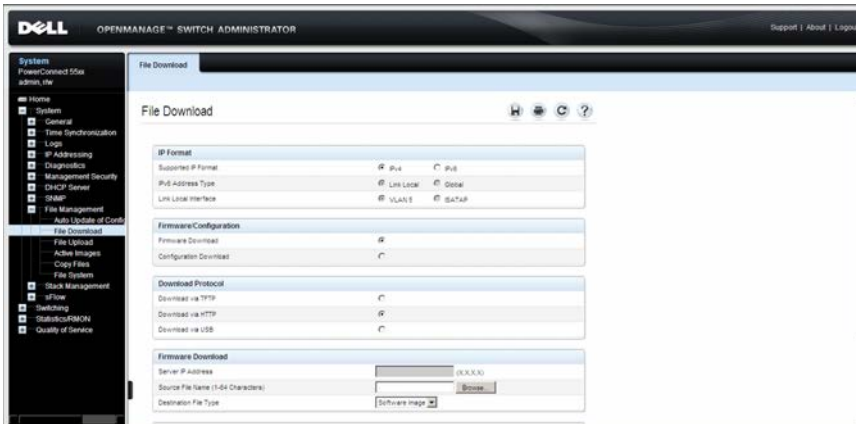

- 2 For HTTP, enter the IP Format fields for the HTTP server IP address.

- **Supported IP Format** — Select whether IPv4 or IPv6 format is supported.
- **IPv6 Address Type** — When the server supports IPv6, this specifies the type of static address supported. The possible options are:
 - **Link Local** — A Link Local address that is non-routable and used for communication on the same network only.
 - **Global** — A globally unique IPv6 address; visible and reachable from different subnets.
- **Link Local Interface** — When the server supports an IPv6 Link Local address, this specifies the Link Local interface. The possible options are:
 - **VLAN** — The VLAN on which the IPv6 interface is configured.
 - **ISATAP** — The IPv6 interface is configured on an ISATAP tunnel.

- 3 Select a **Firmware/Configuration** option. The possible options are:
 - **Firmware Download** — A firmware file is downloaded.
 - **Configuration Download** — A configuration file is downloaded.
- 4 Select to download firmware or a configuration file via a USB port or HTTP in **Download Protocol**.
- 5 If the **Firmware Download** option was selected, enter the following:
 - **Source File Name (1-64 characters)** — The file to be downloaded.
 - **Destination File Type** — The destination file type to which the file is downloaded. The possible options are:
 - **Software Image** — Downloads the Image file. The image file overwrites the non-active image. It is recommended to designate that the non-active image becomes the active image after reset, and then to reset the device following the download. During the Image file download a dialog box opens that displays the download progress, and browsing is disabled.
 - **Boot Code** — Downloads the Boot file.
- 6 If the **Configuration Download** option was selected, enter the following:
 - **Server IP Address** — Enter the IP address of the server.
 - **Source File Name (1-64 Characters)** — Enter the source file name.
 - **Destination File Name** — Select the destination file to which the configuration file is downloaded. The possible options are:
 - **Running Configuration** — Check to download commands into the Running Configuration file. The current file is overwritten.
 - **Startup Configuration** — Check to download commands into the Startup Configuration file. The current file is overwritten.
 - **New File Name (1-64 Characters)** — Check to copy commands into a file in flash memory. Enter the filename.
- 7 Click **Activate** to start the download process.

To download files using TFTP

- 1 Click System > File Management > File Download in the tree view to display the File Download page.

Figure 9-56. File Download

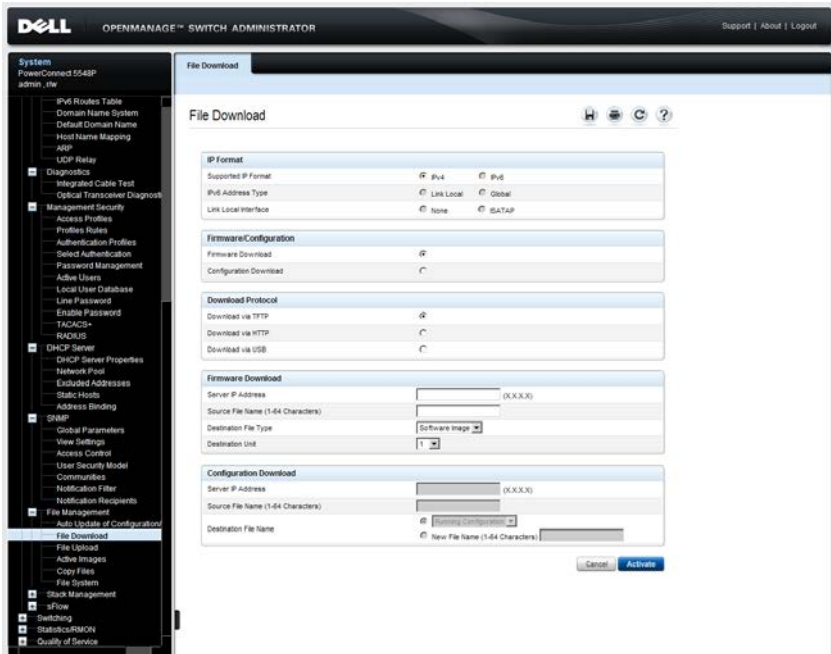

- 2 Enter the IP Format fields for the TFTP server IP address.
 - **Supported IP Format** — Select whether IPv4 or IPv6 format is supported.
 - **IPv6 Address Type** — When the server supports IPv6, this specifies the type of static address supported. The possible options are:
 - **Link Local** — A Link Local address that is non-routable and used for communication on the same network only.
 - **Global** — A globally unique IPv6 address; visible and reachable from different subnets.

- **Link Local Interface** — When the server supports an IPv6 Link Local address, this specifies the Link Local interface. The possible options are:
 - **VLAN** — The VLAN on which the IPv6 interface is configured.
 - **ISATAP** — The IPv6 interface is configured on an ISATAP tunnel.
- 3** Select a **Firmware/Configuration** option. The possible options are:
 - **Firmware Download** — A firmware file is downloaded.
 - **Configuration Download** — A configuration file is downloaded.
- 4** Select to download firmware or a configuration file via a TFTP server in **Download Protocol**.
- 5** If the **Firmware Download** option was selected, enter the following:
 - **Server IP Address** — The IP address of the server from which the firmware file is downloaded.
 - **Source File Name (1-64 characters)** — The file to be downloaded.
 - **Destination File Type** — The destination file type to which the file is downloaded. The possible options are:
 - **Software Image** — Downloads the Image file. The image file overwrites the non-active image. It is recommended to designate that the non-active image becomes the active image after reset, and then to reset the device following the download. During the Image file download a dialog box opens that displays the download progress. The window closes automatically when the download is complete.
 - **Boot Code** — Downloads the Boot file.
- 6** If the **Configuration Download** option was selected, enter the following:
 - **Server IP Address** — The TFTP server IP address from which the configuration files are downloaded.
 - **Source File Name (1-64 characters)** — The configuration file to be downloaded.

- **Destination File Name** — The destination file to which the configuration file is downloaded. The possible options are:
 - **Running Configuration** — Check to download commands into the Running Configuration file. The current file is overwritten.
 - **Startup Configuration** — Check to download commands into the Startup Configuration file. The current file is overwritten.
 - **New File Name (1-64 characters)** — Check to download commands into a configuration backup file. Enter the filename.

7 Click **Activate** to start the download process.

Downloading Files Using CLI Commands

The following table summarizes the CLI commands for setting fields displayed in the **File Download** page.

Table 9-64. File Download CLI Commands

CLI Command	Description
<code>copy source-url destination-url</code>	Copies files from a source to a destination.

The following is an example of the CLI command:

```

console# copy tftp://10.6.6.64/pp.txt startup-config
....!
Copy: 575 bytes copied in 00:00:06 [hh:mm:ss]
01-Jan-2000 06:41:55 %COPY-W-TRAP:
The copy operation was completed successfully

```



NOTE: Each exclamation mark (!) indicates that ten packets were successfully transferred.

File Upload

Software and configuration files can be uploaded to an external device.

- To upload from a USB port or when management computer uses HTTP
- To upload a file or image using TFTP

The following methods can be used:

- To upload from a USB port or when management computer uses HTTP
- To upload a file or image using TFTP

To upload from a USB port or when management computer uses HTTP

- 1 Click System > File Management > File Upload in the tree view to display the File Upload page.

Figure 9-57. File Upload

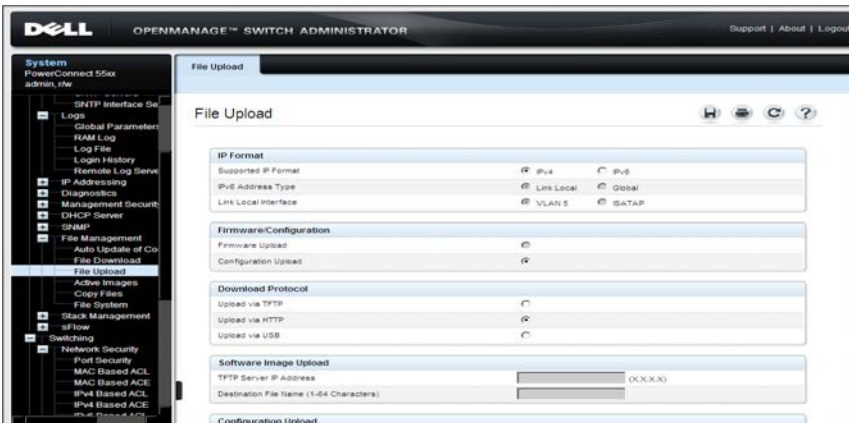

- 2 Configuration Upload is selected automatically.
- 3 Select to upload a configuration file when the management computer is using HTTP or from a USB port in **Download Protocol**.
- 4 Enter the fields:
 - **Transfer File Name** — The configuration file to which the configuration is uploaded. The possible options are:
 - **Running Configuration** — Uploads the Running Configuration file.
 - **Startup Configuration** — Uploads the Startup Configuration file.
- 5 Click **Activate** to start the upload process. A message will be displayed asking where for the path of the destination file.

To upload a file or image using TFTP

- 1 Click System > File Management > File Upload in the tree view to display the File Upload page.

Figure 9-58. File Upload

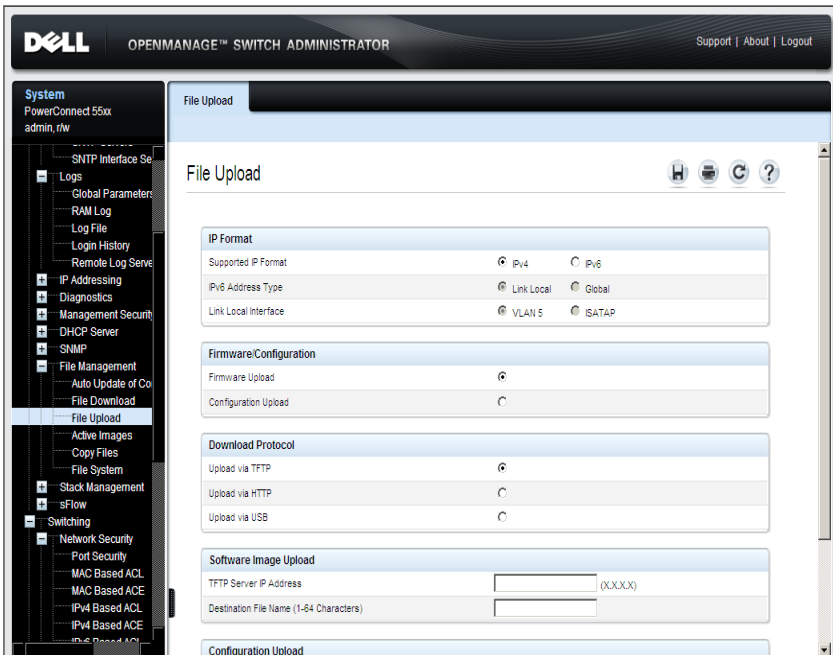

- 2 Enter the IP Format fields for the TFTP server IP address.
 - **Supported IP Format** — Select whether IPv4 or IPv6 format is supported.
 - **IPv6 Address Type** — When the server supports IPv6, this specifies the type of static address supported. The possible options are:
 - **Link Local** — A Link Local address that is non-routable and used for communication on the same network only.
 - **Global** — A globally unique IPv6 address; visible and reachable from different subnets.

- **Link Local Interface** — When the server supports an IPv6 Link Local address, this specifies the Link Local interface. The possible options are:
 - **VLAN** — The VLAN on which the IPv6 interface is configured.
 - **ISATAP** — The IPv6 interface is configured on an ISATAP tunnel.
- 3** Select one of the options:
 - **Firmware Upload** — A firmware file is uploaded.
 - **Configuration Upload** — A configuration file is uploaded.
 - 4** Select to upload firmware or a configuration file via a TFTP server in **Download Protocol**.
 - 5** If **Firmware Upload** was selected, enter:
 - **TFTP Server IP Address** — The TFTP server IP address to which the software image is uploaded.
 - **Destination File Name (1-64 Characters)** — The file name to which the file is uploaded.
 - 6** If **Configuration Upload** was selected, enter:
 - **TFTP Server IP Address** — The TFTP server IP address to which the configuration file is uploaded.
 - **Destination File Name (1-64 Characters)** — The configuration file name/path to which the file is uploaded.
 - **Transfer File Name** — The configuration file that is uploaded. The possible options are:
 - **Running Configuration** — Uploads the Running Configuration file.
 - **Startup Configuration** — Uploads the Startup Configuration file.
 - **User-defined Files** — Uploads the selected file. A user-defined file is only displayed in this list if one was previously created by a user, for example, if the user copied the running configuration file to a user-defined configuration file called BACKUP-SITE-1, the BACKUP-SITE-1 configuration file is displayed in the list and can be selected.
 - 7** Click **Activate** to start the upload process.

Uploading Files Using CLI Commands

The following table summarizes the CLI commands for setting fields displayed in the **File Upload** page.

Table 9-65. File Upload CLI Commands

CLI Command	Description
<code>copy source-url destination-url</code>	Copies any file from a source to a destination.

The following is an example of the CLI commands:

```
console# copy image tftp://10.6.6.64/uploaded.ros
!!!!!!!!!!!!!!!!!!!!!!!!!!!!!!!!!!!!!!!!!!!!!!!!!!!!!!!!!!!!!!!!!!!!!!
Copy: 4234656 bytes copied in 00:00:33 [hh:mm:ss]
01-Jan-2000 07:30:42 %COPY-W-TRAP:
The copy operation was completed successfully
```

Active Images

There are two firmware images, Image1 and Image2, stored on the switch. One of these images is identified as the active image, and the other is identified as the inactive image. The switch boots from the active image.

You can switch the inactive image to the active image, and then reboot the switch.

The active image file for each unit in the stack can be individually selected.

To select the image file to be used after reset:

- 1 Click **System > File Management > Active Images** in the tree view to display the **Active Images** page.

Figure 9-59. Active Images

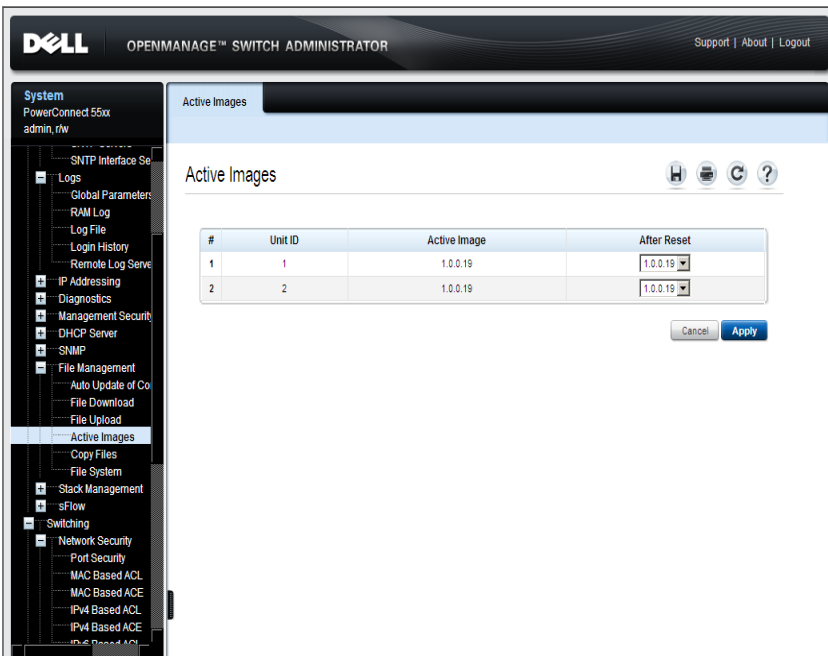

The following fields are displayed:

- **Unit ID** — ID of the unit.

- **Active Image** — The name of the image file that is currently active on the unit in the stack.
- **After Reset** — The image file that will be active on the unit in the stack after the device is reset. The possible options are:
 - **Image 1** — Activates Image file 1 after the device is reset.
 - **Image 2** — Activates Image file 2 after the device is reset.

2 Click **Apply** to select the image file to be used after reset in **After Reset**.

Working with the Active Image File Using CLI Commands

The following table summarizes the CLI commands for viewing fields displayed in the **Active Images**.

Table 9-66. Active Image CLI Commands

CLI Command	Description
boot system { <i>image-1</i> <i>image-2</i> } [<i>switch number</i> all]	Sets the system image that the device loads at startup.
show version [<i>unit unit</i>]	Displays version information for the system

The following is an example of the CLI commands:

```
console# boot system image-1 all
```

Copy Files

Firmware and configuration files can be copied between units in the stack.

Use the **Copy Files** page to perform the following:

- Copy the firmware on the Master unit to another unit in the stack.
- Copy the master Running Configuration file to the master sTartup Configuration file, or copy the configuration to a user-defined configuration file.
- Copy the master Startup Configuration file to a backup file on the Flash file system or to a USB if available.

- Copy a configuration file to the Running Configuration file. It is important to be aware that copying a file to the Running Configuration file actually executes these commands, so some of the configuration commands might fail (for example when trying to create a VLAN that is already defined on the system).
- Restore configuration factory defaults.

To copy files:

- 1 Click **System > File Management > Copy Files** in the tree view to display the **Copy Files** page.

Figure 9-60. Copy Files

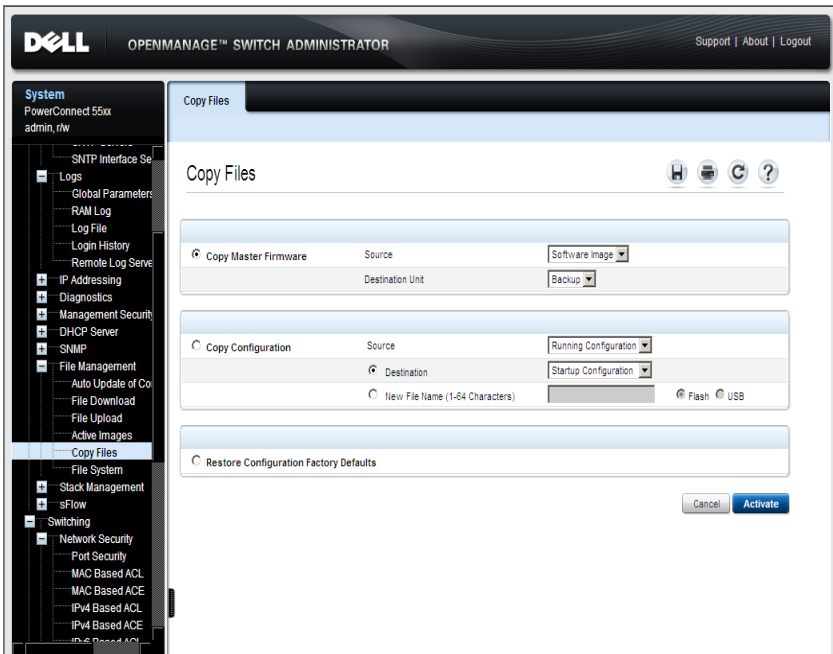

- 2 To copy the firmware from the Master unit to the Backup Master unit or to all other units, select **Copy Master Firmware** and select the options:
 - **Source** — Select either the current Master unit’s software image file or boot code file.

- **Destination Unit** — Check to copy the firmware to either the Backup Master unit or all units in the stack.
- 3 To copy the Running Configuration file of the Master unit to the Startup Configuration file of the Master unit or vice versa, select **Copy Configuration Firmware** and enter the options:
 - **Source** — Select either the Running Configuration or the Startup Configuration file.
 - **Destination** — Select either the Running Configuration, Startup Configuration file or user-created flash files, depending on the source configuration file.
- or
- **New File Name (1-64 characters)** — To copy the source file to a user-named file, enter the name of a file. If this option is selected, check where the file is stored: **Flash** or **USB**.
- 4 Select **Restore Configuration Factory Defaults** to replace the current configuration settings by the factory configuration default settings.
 - 5 Click **Activate** to initiate the selected process.

Copying Files Using CLI Commands

The following table summarizes the CLI commands for performing actions provided by the Copy Files page.

Table 9-67. Copy Files CLI Commands

CLI Command	Description
<code>copy source-url destination-url</code>	Copies any file from a source to a destination.
<code>delete startup-config</code>	Deletes the startup-config file.
<code>delete url</code>	Deletes a file from the FLASH memory device.

The following is an example of the CLI commands:

```
console# delete startup-config
Delete startup-config [y/n]? y
console# 01-Oct-2006 16:10:51 %FILE-I-DELETE: File Delete -
file URL flash://startup-config
console# copy running-config startup-config
Overwrite file [startup-config] ?[Yes/press any key for
no]...01-Oct-2006 16:11
:47 %COPY-I-FILECPY: Files Copy - source URL running-config
destination URL flash://startup-config
01-Oct-2006 16:12:01 %COPY-N-TRAP:
The copy operation was completed successfully
Copy succeeded
```

File System

Use the **File System** page to view information about files currently stored on the system, including file names, file sizes, files modifications, and file permissions. The file system permits managing up to two user-defined backup configuration files.

To view information about files:

- 1 Click **System > File Management > File System** in the tree view to display the **File System** page.

Figure 9-61. File System

The screenshot displays the 'File System' page in the Dell OpenManage Switch Administrator. The page title is 'File System' and it includes a navigation tree on the left. The main content area shows a table of files with the following data:

#	File Name	Size	Modified	Permission	Remove	Rename
1	backup	1806	01-Oct-2006	Read Write	<input type="checkbox"/>	
2	image-1	6029312	01-Oct-2006	Read Write	<input type="checkbox"/>	
3	image-2	6029312	01-Oct-2006	Read Write	<input type="checkbox"/>	
4	dhcpn.prv	0	01-Oct-2006	No Read	<input type="checkbox"/>	
5	aaafn.prv	0	01-Oct-2006	No Read	<input type="checkbox"/>	
6	syslog1.sys	0	01-Oct-2006	Read	<input type="checkbox"/>	
7	syslog2.sys	0	01-Oct-2006	Read	<input type="checkbox"/>	
8	directy.prv	0	01-Oct-2006	No Read	<input type="checkbox"/>	
9	startup-config	1963	01-Oct-2006	Read Write	<input type="checkbox"/>	

Below the table, there are summary statistics:

Total Bytes	Free Bytes
16252928	1835008

The interface also includes a 'File Location' dropdown menu with options for 'Flash' and 'USB', and 'Cancel' and 'Apply' buttons at the bottom right.

- 2 Select the File Location. The possible options are:
 - **Flash** — Files in flash memory are displayed.
 - **USB** — Files on the USB device are displayed.

The following information is displayed for all files in the system:

- **File Name** — The name of the file currently stored in the file management system.
 - **Size** — The file size.
 - **Modified** — The date the file was last modified.
 - **Permission** — The permission type assigned to the file.
- 3** The following system-wide information is displayed if **Flash** was selected:
- **Total Bytes** — The total amount of the space currently being used.
 - **Free Bytes** — The remaining amount of space currently free. Total bytes and free bytes are not available when selecting USB.
- 4** To rename a file, click its **Rename** button. Change the **File Name**.

Managing Files Using CLI Commands

The following table summarizes the CLI command for viewing system files.

Table 9-68. File Management CLI Command

CLI Command	Description
<code>dir [flash:// usb://]</code>	Display list of files on a flash file system
<code>rename url new-url</code>	Renames a file
<code>delete url</code>	Deletes a file

The following is an example of the CLI commands:

```

console# dir flash://
Directory of flash:
File Name      Permission Flash Size Data Size      Modified
-----
1.cfg          rw          524160    14065    05-Oct-2006 21:20:36
2.cfg          rw          524160    14065    7-Oct-2006 09:11:07
aaafile.prv   --          65520     --       03-Oct-2006 15:45:41
dhcpdb.sys    r-          65520     --       01-Oct-2006 19:22:49
Total size of flash: 16121856 bytes
Free size of flash: 524768 bytes

```

Stack Management

This section describes how to manage the stack.

It consists of the following topics:

- Stack Management Overview
- Stack Unit ID
- Versions
- Reset
- Unit Identification (Location)

Stack Management Overview

A stack consists of up to eight units, with support for up to 400 network ports. Unit 1 usually acts as the stack master and Unit 2 is the backup master. All other units act as slaves.

The entire stack, without regard to the stack topology or the number of units in the stack, can be managed as a single switch.

For more information about stacking, see "Stacking Overview" on page 43.

The stacking pages described in this section enable the following actions:

- Switching from the Master unit to the Backup Master unit
- Changing unit IDs
- Viewing hardware and software versions on each unit
- Resetting either a unit or all the units in the stack
- Setting the Location LED on a unit(s)

Stack Unit ID

Use the **Stack Unit ID** pages to:

- Switch stack control from the Master unit to the Backup Master unit
- Change unit IDs, or enable them to be automatically numbered by the system

To switch from the Backup Master unit to the Master Unit or set unit IDs:

- 1 Click **System > Stack Management > Stack Unit ID** in the tree view to display the **Stack Unit ID** page.

Figure 9-62. Stack Unit ID

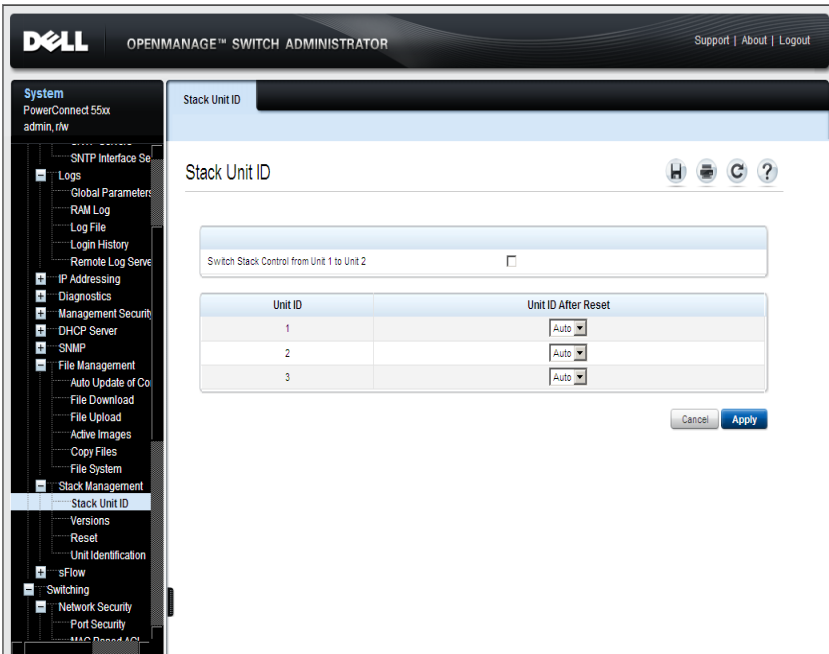

- 2 Enter the fields:
 - **Switch Stack Control from Unit 1 to Unit 2** — Check this field to make unit 2 the Master unit.
 - **Unit ID After Reset** — Select **Auto** if you want the system to assign the unit ID after reset. Select a number to assign the unit an ID manually.

Managing Stacks Using the CLI Commands

The following table summarizes the CLI commands for setting fields displayed in the **Stack Unit ID** page.

Table 9-69. Stack Unit ID CLI Commands

CLI Command	Description
stack master <i>unit</i>	Makes the unit specified be the Master unit.
no stack master	Use the no version to restore the default Master unit.
switch <i>current-unit-number</i> renumber <i>new-unit-number</i>	Changes the unit ID of a specific unit.

The following is an example of the CLI commands:

```
console(config)# stack master unit 2  
console(config)# switch 3 renumber 6
```

Versions

To view the hardware and software versions currently running on the switch:

- Click **System > Stack Management > Versions** in the tree view to display the Versions page.

Figure 9-63. Versions

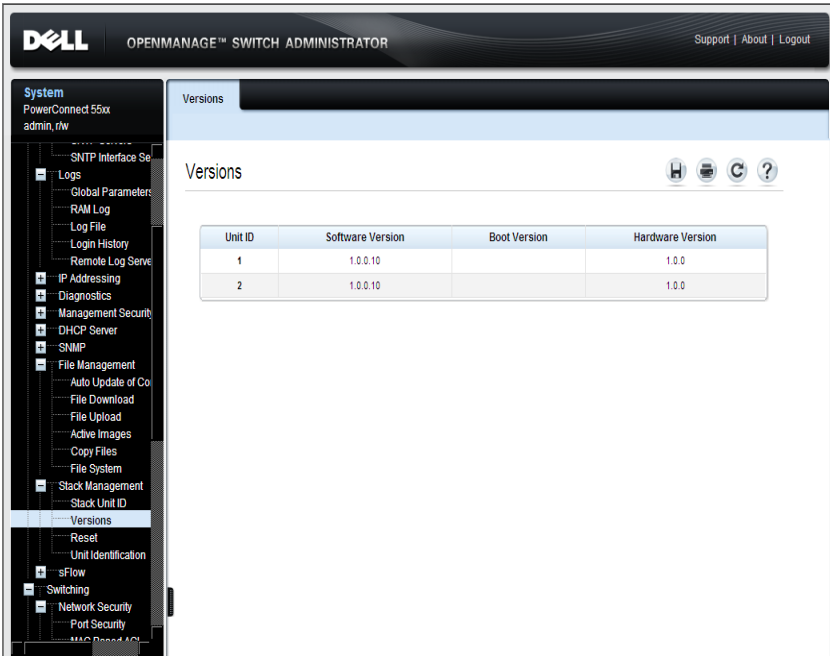

The following fields are displayed:

- **Unit ID** — The unit number for which the device versions are displayed.
- **Software Version** — The current software version running on the device.
- **Boot Version** — The current Boot version running on the device.
- **Hardware Version** — The current device hardware version.

Displaying Device Versions Using the CLI

The following table summarizes the CLI commands for viewing fields displayed in the Versions page.

Table 9-70. Versions CLI Commands

CLI Command	Description
<code>show version [unit-id]</code>	Displays system version information for a unit or for the whole stack.

The following is an example of the CLI commands:

```
console> show version 2
```

Unit	SW Version	Boot Version	HW Version
2	1.0.0.8	1.0.0.02	00.00.01

Reset

Use the **Reset** page to reset the device from a remote location.

To reset a unit in the stack:

- 1 If changes were made to the Running Configuration file, save them to the Startup Configuration file before resetting the device. This prevents the current device configuration from being lost. For more information about saving Configuration files, see "Copy Files" on page 355.

- 2 Click System > Stack Management > Reset in the tree view to display the Reset page.

Figure 9-64. Reset

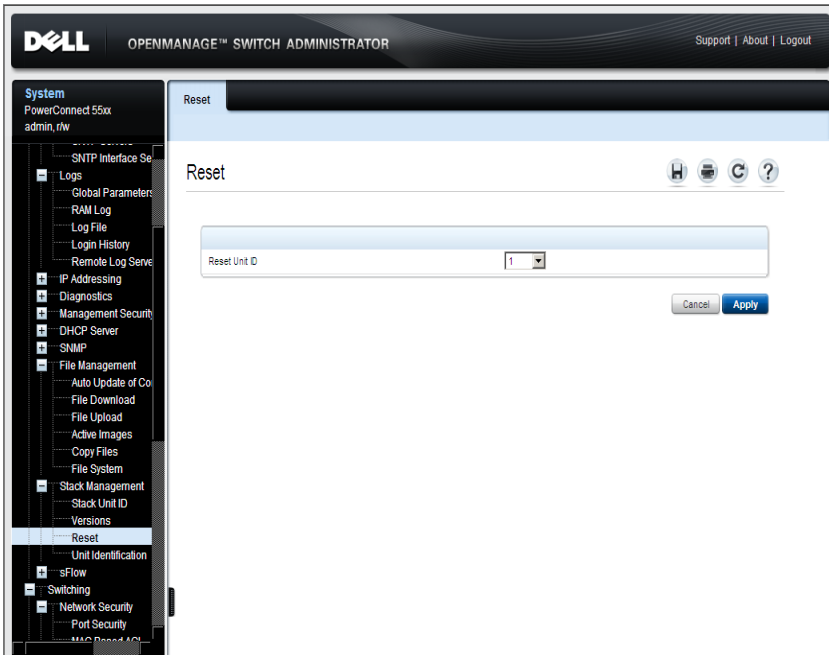

- 3 In the Reset Unit ID field, select either the unit ID to be reset or Stack to reset all the units in the stack.

Resetting the Device Using the CLI

The following table summarizes the CLI commands for performing a reset of the device via the CLI:

Table 9-71. Reset CLI Command

CLI Command	Description
<code>reload [slot unit]</code>	Reloads the operating system of a single unit or of all the units.

The following is an example of the CLI command:

```
console# reload
```

```
You haven't saved your changes. Are you sure you want to  
continue? (Y/N)[N] Y
```

```
This command will reset the whole system and disconnect  
your current session. Do you want to continue? (Y/N)[N]
```

Unit Identification (Location)

The Location LED on a unit helps you to discover a specific unit, or indeed, all the units in a stack.

To light up the Location LED:

- 1 Click **System > Stack Management > Unit Identification** in the tree view to display the **Unit Identification** page.

Figure 9-65. Unit Identification

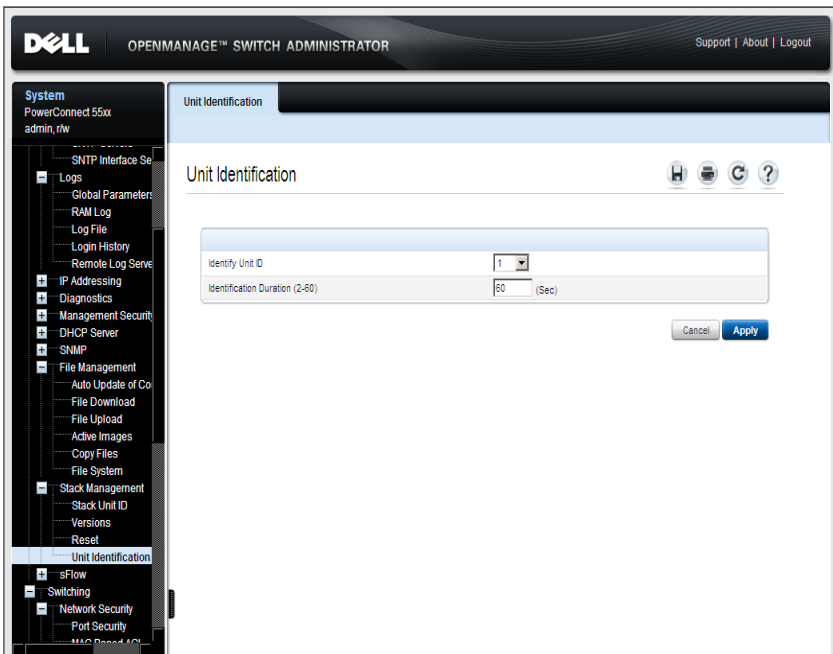

2 Enter the fields:

- **Identify Unit ID**—Select a unit. This unit’s Location and Power LED start blinking. Select **All** to cause the Location LEDs in all the units in the stack to light up.
- **Identification Duration (2-60)**—Enter a time interval. The Location and Power LED light up for this period of time.

Setting the Location LED Using the CLI

The following table summarizes the CLI commands for setting the Location LED:

Table 9-72. Location LED CLI Commands

CLI Command	Description
<code>system light [unit unit-number] [duration seconds]</code>	Lights the location LED on a specific unit.
<code>system light stop</code>	Use the no form of this command to turn off the light.

The following is an example of the CLI command:

```
console# system light unit 1
```

sFlow

This section describes sFlow monitoring of traffic.

It contains the following sections:

- sFlow Overview
- Workflow
- sFlow Receiver Settings
- sFlow Interface Settings
- sFlow Statistics

sFlow Overview

The sFlow feature enables collecting statistics using the sFlow sampling technology, based on sFlow V5.

This sampling technology is embedded within switches and routers. It provides the ability to continuously monitor traffic flows on some or all the interfaces, simultaneously.

The sFlow monitoring system consists of an sFlow agent (embedded in a switch or router or in a stand alone probe) and a central data collector, known as the sFlow receiver.

The sFlow agent uses sampling technology to capture traffic and statistics from the device it is monitoring. sFlow datagrams are used to forward the sampled traffic and statistics to an sFlow receiver for analysis.

sFlow V5 defines:

- How traffic is monitored.
- The sFlow MIB that controls the sFlow agent.
- The format of the sample data used by the sFlow agent when forwarding data to a central data collector. The device provides support for two types of sFlow sampling: flow sampling and counters sampling. The following counters sampling is performed according to sFlow V5 (if supported by the interface):
 - Generic interface counters (RFC 2233)
 - Ethernet interface counters (RFC 2358)

Workflow

By default, flow and counter sampling are disabled.

To enable sFlow sampling:

- 1** Set the IP address of a receiver (also known as a collector) for sFlow statistics. Use the **sFlow Receivers Settings** page for this.
- 2** Enable flow and/or counter sampling, direct the samples to a receiving interface, and configure the average sampling rate. Use the **sFlow Interface Settings** pages for this.
- 3** View and clear the sFlow statistics counters. Use the **sFlow Statistics** page for this.

sFlow Receiver Settings

To set the sFlow receiver parameters:

- 1 Click **System > sFlow > sFlow Receivers Settings** in the tree view to display the **sFlow Receivers Settings: Summary** page.

Figure 9-66. sFlow Receivers Settings: Summary

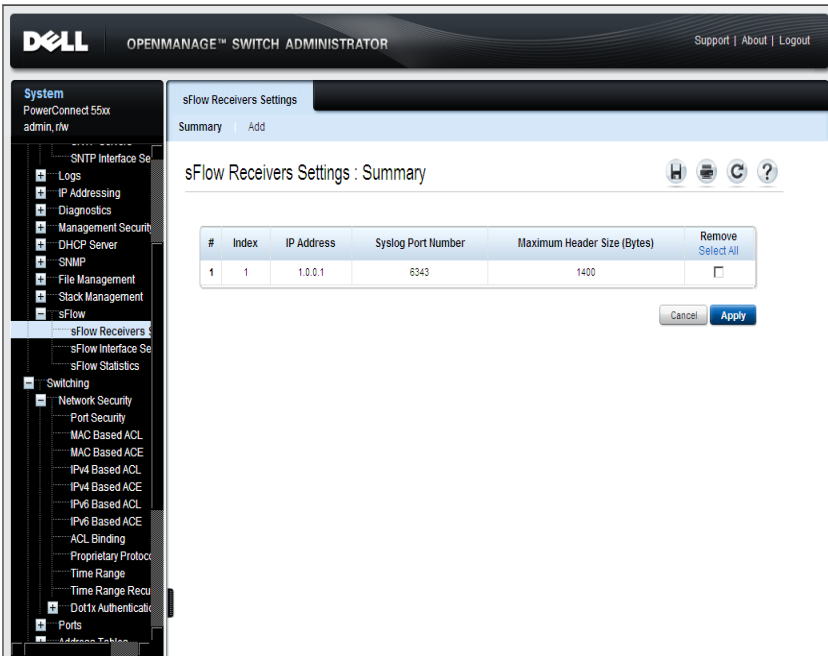

The sflow parameters are displayed.

- 2 To add a receiver (sflow analyzer), click **Add** and select one of the pre-defined sampling definition indices in **Index**.
- 3 Enter the receiver's address fields:
 - **Supported IP Format** — Select whether IPv4 or IPv6 format is supported.

- **IPv6 Address Type** — When the server supports IPv6, this specifies the type of static address supported. The possible options are:
 - **Link Local** — A Link Local address that is non-routable and used for communication on the same network only.
 - **Global** — A globally unique IPv6 address; visible and reachable from different subnets.
 - **Link Local Interface** — When the server supports an IPv6 Link Local address, this specifies the Link Local interface. The possible options are:
 - **None** — Disable the ISATAP tunnel.
 - **ISATAP** — The IPv6 interface is configured on an ISATAP tunnel.
 - **IP Address** — Enter the receiver’s IP address.
- 4** Enter the fields:
- **Syslog Port Number** — Port to which SYSLOG message are sent.
 - **Maximum Header Size (Bytes)** — Maximum number of bytes that can be sent to the receiver in a single sample datagram (frame).

Adding an sFlow Receiver Using the CLI Commands

The following table summarizes the CLI commands for adding an sFlow receiver.

Table 9-73. sflow Receiver CLI Commands

CLI Command	Description
<code>sflow receiver index {ipv4-address ipv6-address hostname} [port port] [max-datagram-size bytes]</code>	Defines an sFlow receiver.
<code>no sflow receiver index</code>	Use the no form of this command to remove the definition of the receiver.
<code>show sflow configuration [port_id]</code>	Displays the sFlow configuration for ports that are enabled for Flow sampling or Counters sampling.

The following is an example of the CLI commands:

```
console(config)# sflow receiver 2 1.1.1.1 port 6343
console# show sflow configuration
Receivers
Index          IP Address          Port    Max Datagram Size
-----
1              0.0.0.0             6343    1400
2              172.16.1.2          6343    1400
3              0.0.0.0             6343    1400
4              0.0.0.0             6343    1400
5              0.0.0.0             6343    1400
6              0.0.0.0             6343    1400
7              0.0.0.0             6343    1400
8              0.0.0.0             6343    1400

Interfaces
Interface Flow    Counters          Max Header    Collector    Index
          Sampling  Sampling Interval Size           Sampling    Counters
-----
gil/0/1  1/2048    60 sec           128           1            1
gil/0/2  1/4096    Disabled         128           0            2
```

sFlow Interface Settings

To sample datagrams or counters from a port, the port must be associated with a receiver. sFlow port settings can be configured only after a receiver has been defined in the **sFlow Receiver Settings** pages.

To enable sampling and configure the port from which to collect the sFlow information:

- 1 Click **System > sFlow > sFlow Interface Settings** in the tree view to display the **sFlow Interface Settings: Summary** page.

Figure 9-67. sFlow Interface Settings: Summary

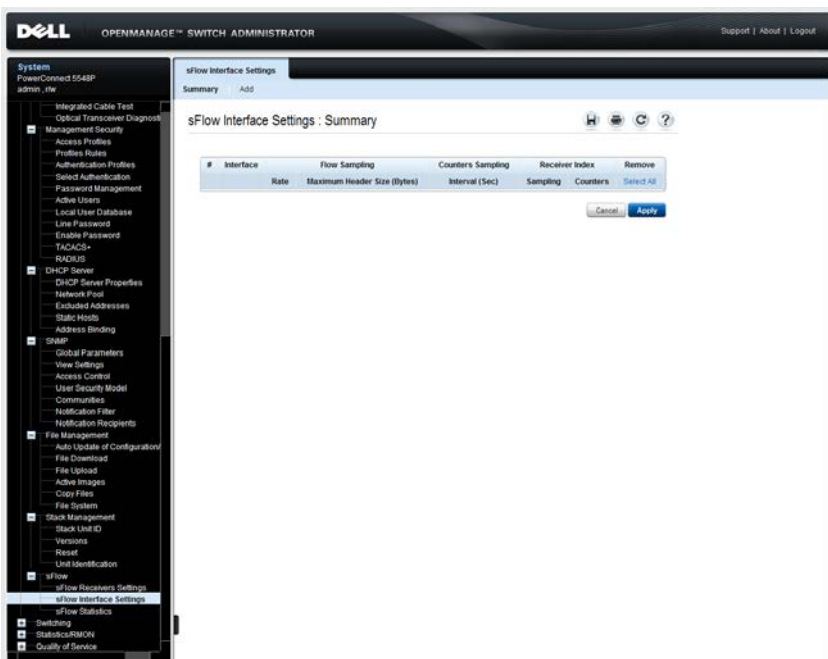

The sflow interface settings are displayed.

- 2 To associate an sFlow receiver with a port, click **Add**, and enter the fields:
 - **Interface** — Select the unit/port from which information is collected.
 - **Flow Sampling** — Enable/disable flow sampling. Flow sampling cannot be disabled if **Counters Sampling** is disabled.

- **Flow Sampling Average Sampling Rate(1024–1073741823)** — If x is entered, a flow sample will be taken for each x frames.
- **Flow Sampling Receiver Index** — Select one of the indices that was defined in the **sFlow Receivers Settings** pages.
- **Flow Sampling Maximum Header Size (20–256)** — Maximum number of bytes that should be copied from a sampled packet.
- **Counters Sampling** — Enable/disable counters sampling. Flow sampling cannot be disabled if **Flow Sampling** is disabled
- **Counters Sampling Interval (15–86400)** — If x is entered, this specifies that a counter sample will be taken for each x seconds.
- **Counters Sampling Receiver Index** — Select one of the indices that was defined in the **sFlow Receivers Settings** pages.

Configuring sFlow Interfaces Using the CLI Commands

The following table summarizes the CLI commands for configuring sFlow interfaces.

Table 9-74. sflow Interface CLI Commands

CLI Command	Description
sflow flow-sampling rate receiver-index [max-header-size bytes]	Enables sFlow Flow sampling and configure the average sampling rate of a specific port.
no sflow flow-sampling	Use the no form of this command to disable Flow sampling.
sflow counters-sampling interval receiver-index	Enable sFlow counters sampling and to configure the maximum interval of a specific port.
no sflow counters-sampling	Use the no form of this command to disable sFlow Counters sampling.

The following is an example of the CLI commands:

```
console(config)# interface gi2/0/3
console(config-if)#sflow flow-sampling 1024 1
```

sFlow Statistics

To view sFlow statistics:

- 1 Click **System > sFlow > sFlow Statistics** in the tree view to display the sFlow Statistics page.

Figure 9-68. sFlow Statistics

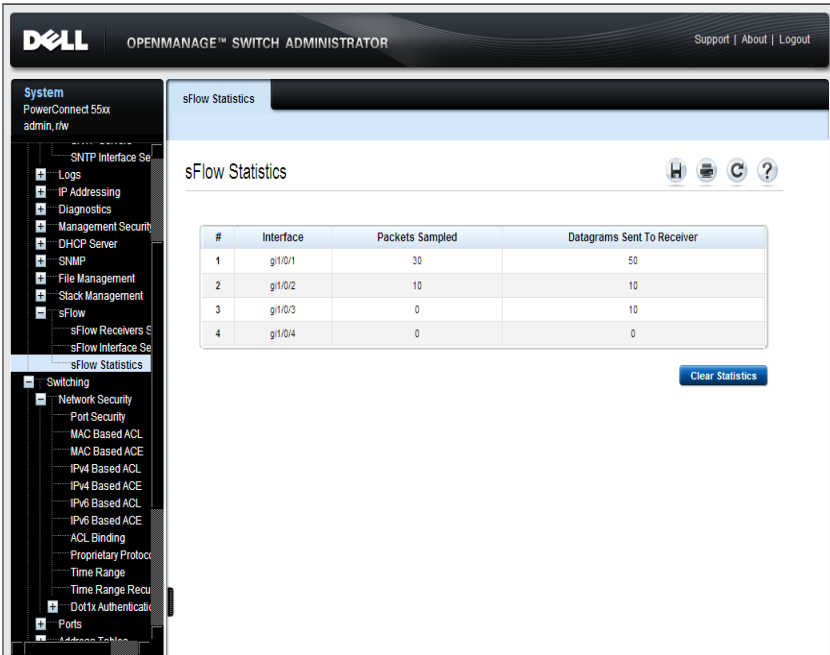

The following sflow statistics per interface are displayed:

- **Interface** — Port for which sample was collected.
 - **Packets Sampled** — Number of packets sampled.
 - **Datagrams Sent to Receiver** — Number of sFlow sampling packets sent.
- 2 Click **Clear Statistics** to clear the counters.

Viewing sFlow Statistics Using the CLI

The following table summarizes the CLI commands for viewing sFlow statistics:

Table 9-75. sFlow Statistics CLI Command

CLI Command	Description
show sflow statistics [<i>port-id</i>]	Displays sFlow statistics for ports that are enabled for Flow sampling or Counters sampling.
clear sflow statistics [<i>port-id</i>]	Clears sFlow statistics for ports that are enabled for Flow sampling or Counters sampling.

The following is an example of the CLI commands:

```
console # show sflow statistics
Total sFlow datagrams sent to collectors: 100
Interface Packets Sampled Datagrams Sent to Collector
-----
gi1/0/1    30      50
gi1/0/2    10      10
gi2/0/1    0       10
gi2/0/2    0       0
```

10

Ports

This section describes how to configure port functionality.

It contains the following topics:

- Overview
- Jumbo Frames
- Green Ethernet Configuration
- Protected Ports
- Port Profile
- Port Configuration
- LAG Configuration
- Storm Control
- Port Mirroring

Overview

This section includes a description of port features and describes the following:

- Auto-Negotiation
- MDI/MDIX
- Flow Control
- Back Pressure
- Port Default Settings

Auto-Negotiation

Auto-negotiation enables automatic detection of speed, duplex mode and flow control on all switching 10/100/1000BaseT ports. Auto-negotiation is enabled on all ports by default.

Auto-negotiation is a mechanism established between two link partners to enable a port to advertise its transmission rate, duplex mode and flow control abilities to its partner. Both ports then operate at the highest common denominator.

If connecting a Network Interface Card (NIC) that does not support auto-negotiation or is not set to auto-negotiation, both the device switching port and the NIC must be manually set to the same speed and duplex mode.

If the station, on the other side of the link, attempts to auto-negotiate with a device 100BaseT port that is configured to full duplex, the auto-negotiation results in the station attempting to operate in half duplex.

MDI/MDIX

The device supports auto-detection of straight-through and crossed cables on all 10/100/1000BaseT ports. This feature is part of auto-negotiation and is enabled when Auto-negotiation is enabled.

When the MDI/MDIX (Media Dependent Interface with Crossover) is enabled, the automatic correction of errors in cable selection is possible, thus making the distinction between a straight-through cable and a crossover cable

irrelevant. The standard wiring for end stations is known as MDI (Media Dependent Interface), and the standard wiring for hubs and switches is known as MDIX.

Flow Control

The device supports 802.3x flow control for ports configured to Full Duplex mode. By default, this feature is enabled on all ports, and it can be disabled per port.

Flow control creates a lossless link with no packet loss. The flow control mechanism enables the receiving side to signal to the transmitting side that transmission must temporarily be halted to prevent buffer overflow. This signaling is done by sending PAUSE frames. The ports that receives pause frames stops transmitting traffic.

Flow control on the device works in Receive-Only mode, meaning that the interfaces with enabled flow control receive PAUSE frames, but do not send them.

When flow control is enabled, the system buffers are allocated per port so that if the buffers of one port are consumed, other ports will still have their free buffers.

Back Pressure

The device supports back pressure for ports configured to Half Duplex mode. By default, this feature is disabled, and it can be enabled per port. The back-pressure mechanism prevents the sender from transmitting additional traffic temporarily. The receiver may occupy a link so it becomes unavailable for additional traffic.

Port Default Settings

Table 12-1 describes the port default settings.

Table 10-1. Port Default Settings

Function	Default Setting
Port speed and mode	10/100/1000 BaseT copper: auto-negotiation SFP+ 1000/10G Mbps full duplex, auto discovery
Port forwarding state	Enabled

Table 10-1. Port Default Settings (Continued)

Function	Default Setting
Port tagging	No tagging
Flow Control	On
Back Pressure	Off

Jumbo Frames

Jumbo frames are frames of up to 10 Kb in size. If Jumbo frames are not enabled, the system supports a packet size of up to 1,632 bytes.

To enable jumbo frames:

- 1 Click **Switching > Ports > Jumbo Frames** in the tree view to display the Jumbo Frames page.

Figure 10-1. Jumbo Frames

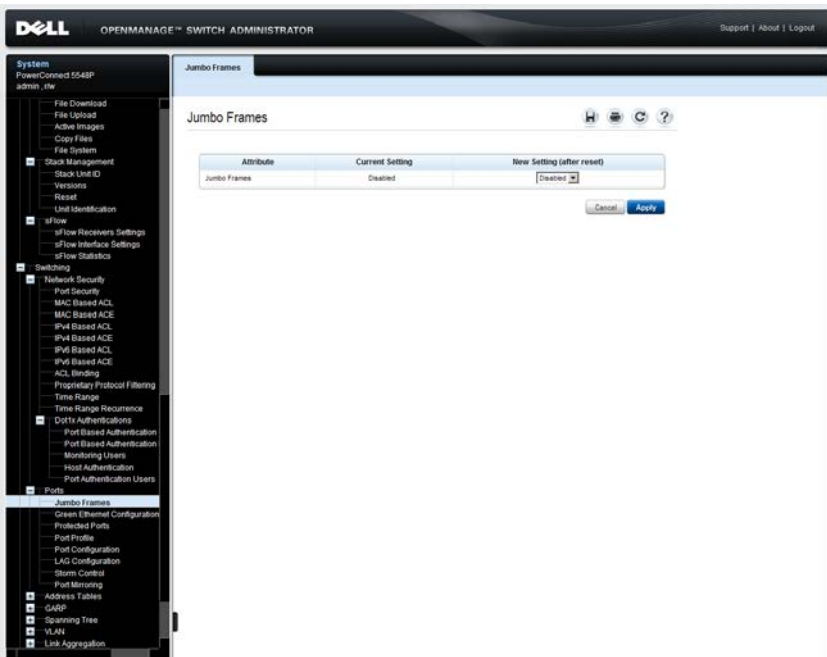

The current jumbo frames setting is displayed

- 2 Enable/disable jumbo frames in the **New Setting (after reset)** field.

NOTE: You must save the configuration and reboot the device in order to make jumbo frames operational.

Configuring Jumbo Frames Using CLI Commands

The following table summarizes the CLI commands for configuring Jumbo frames.

Table 10-2. Jumbo Frames CLI Commands

CLI Command	Description
<code>port jumbo-frame</code>	Enables jumbo frames on the device.
<code>no port jumbo-frame</code>	Use the no form of this command to disable jumbo frames.

The following is an example of the CLI commands:

```
console(config)# port jumbo-frame
```

Green Ethernet Configuration

Green Ethernet is a name of a set of features that are designed to reduce the power consumption of a device, and so make it environmentally friendly.

The Green Ethernet feature reduces overall power usage in the following ways:

- **Energy Efficient Ethernet** — When using EEE, systems on both sides of the link can disable portions of their functionality and save power during periods of low link utilization. EEE is a hardware feature that is enabled by default, and is transparent to users. This feature is defined per port, regardless of their LAG membership.
- **Short-Reach Mode** — Power usage is adjusted to the actual cable length. In this mode, the VCT (Virtual Cable Tester) length test is performed to measure cable length. If the cable is shorter than a predetermined length, the switch reduces the power used to send frames over the cable, thus saving energy. This mode is only supported on RJ45 ports.

Power savings and current power consumption in Short Reach mode can be monitored. The total amount of saved energy can be viewed as a percentage of the power that would have been consumed by the physical interfaces had they not been running in Green Ethernet mode.

The above two energy saving modes must be enabled globally and then configured per port.

Green Ethernet Configuration

To configure Green Ethernet settings:

- 1 Click **Switching > Ports > Green Ethernet Configuration** in the tree view to display the **Green Ethernet Configuration: Summary** page.

Figure 10-2. Green Ethernet Configuration: Summary

The screenshot shows the Dell OpenManage Switch Administrator interface. The left sidebar contains a navigation tree with categories like System, Switching, Network Security, and Ports. The main content area is titled "Green Ethernet Configuration" and "Summary". It displays the following information:

- Cumulative Energy Saved: 552 W * H (with a Reset button)
- Energy Efficient Ethernet: Enabled
- Link Short-Reach Energy Saving Mode: Enabled
- Current Power Consumption: mW
- Power Saving: 15% (with a green progress bar)
- Unit ID: 1
- A table with 5 columns: #, Port, Energy Efficient Ethernet (Oper, Remote Peer), Short-Reach (Oper, Fault Reason), and Cable Length (Meter).

#	Port	Energy Efficient Ethernet		Short-Reach		Cable Length (Meter)
		Oper	Remote Peer	Oper	Fault Reason	
1	g1/0/1	off	on	off	LinkType	
2	g1/0/2	off	on	off	LinkSpeed	
3	g1/0/3	on	on	on		50-00
4	g1/0/4	off	on	off		
5	g1/0/5	off	on	off		

- 2 The amount of energy saved from the last switch reboot is displayed in the **Cumulative Energy Saved** field. This value is updated each time there is an event that affects power saving. Click **Reset** to reset its value.
- 3 Enter the fields:
 - **Energy Efficient Ethernet** — Globally enable/disable the Energy Efficient Ethernet feature.
 - **Link Short-Reach Energy Saving Mode** — Globally enable/disable Short Reach mode.

- **Current Power Consumption** — Displays the current power consumption.
 - **Power Savings** — Displays the percentage of power saved by running in Green Ethernet mode.
- 4 Select a unit in the stack to display its power consumption parameters. Its ports are displayed along with the following settings.
 - **Energy Efficient Ethernet**
 - **Oper** — Enabled or not on the port
 - **Remote Peer** — Enabled or not on the remote peer
 - **Short-Reach**
 - **Oper** — Enabled or not on the port
 - **Fault Reason** — Reason that short reach is not enabled
 - **Cable Length (Meter)** — Length of cable.
 - 5 Click **LLDP Interface Details**.
 - 6 Select a unit in the stack. The following is displayed for each port on the unit:
 - **Port** — Port number.
 - **Oper** — Displays the operational status of Green Ethernet.
 - **Resolved Tx Timer (μsec)** — Integer that indicates the current `Tw_sys_tx` is supported by the local system.
 - **Local Tx Timer (μsec)** — Indicates the time (in micro seconds) that the transmitting link partner waits before it starts transmitting data after leaving Low Power Idle (LPI mode).
 - **Resolved Rx Timer (μsec)** — Integer that indicates the current `Tw_sys_tx` supported by the remote system.
 - **Local Rx Timer (μsec)** — Indicates the time (in micro seconds) that the receiving link partner requests that the transmitting link partner waits before transmission of data following Low Power Idle (LPI mode).
 - **Remote Tx Timer (μsec)** — Indicates the local link partner's reflection of the remote link partner's Tx value.

- Remote Rx Timer (μsec) — Indicates the local link partner’s reflection of the remote link partner’s Rx value.

Configuring Green Ethernet Using CLI Commands

The following table summarizes the CLI commands for configuring Green Ethernet.

Table 10-3. Green Ethernet CLI Commands

CLI Command	Description
<code>green-ethernet short-reach</code>	Enables/disables Green Ethernet short reach mode.
<code>no green-ethernet short-reach</code>	
<code>green-ethernet short-reach force</code>	Forces short-reach mode on an interface.
<code>no green-ethernet short-reach force</code>	Use the no form of this command to return to the default.
<code>green-ethernet short-reach threshold <i>cable-length</i></code>	Set the maximum cable length for applying short-reach mode.
<code>no green-ethernet short-reach threshold</code>	Use the no form of this command to return to the default.
<code>green-ethernet power-meter reset</code>	Resets the power save meter.
<code>eee enable</code>	Enables the EEE mode globally. Can be used globally or per interface.
<code>no eee enable</code>	Use the no format of the command to disable the mode.
<code>eee lldp enable</code>	Enables EEE support by LLDP on an Ethernet port.
<code>no eee lldp enable</code>	Use the no format of the command to disable the support.
<code>show eee</code>	Displays EEE information.

Protected Ports

Protected Port Overview

Protected ports provide Layer 2 isolation between interfaces (Ethernet ports and LAGs) that share the same Broadcast domain (VLAN) with other interfaces. This can be used to set up a group of ports that receive similar services.

A protected port does not forward traffic (Unicast, Multicast, or Broadcast) to any other protected port on the same switch.

A community is a group of protected ports. Protected ports within the same community can forward traffic to each other.

The following types of ports can be defined:

- **Protected Port** — Can send traffic only to uplink ports.
- **Community Port** — A protected port that is associated with a community. It can send traffic to other protected ports in the same community and to uplink ports.
- **Uplink Port** — An uplink port is an unprotected port that can send traffic to any port.
- **Isolated Port** — A protected port that does not belong to a community.

Port Protection is independent of all other features and configuration settings. Two protected ports in a common VLAN cannot communicate with each other.

Protected Port Restrictions

The following restrictions apply to protected ports:

- When a protected port is placed in a LAG, it loses its protected port attribute and takes upon itself the LAG's protection attributes. When the port is removed from the LAG, its attributes are re-applied.
- Mirrored traffic is not subject to protected ports rules.
- Routing is not affected by the protected port forwarding rule, so that if a packet enters a protected port, it can be routed by the device to another protected port.

Protected Port Configuration

To configure protected ports and establish their communities:

- 1 Click **Switching > Ports > Protected Ports** in the tree view to display the **Protected Ports: Summary** page.

Figure 10-3. Protected Ports: Summary

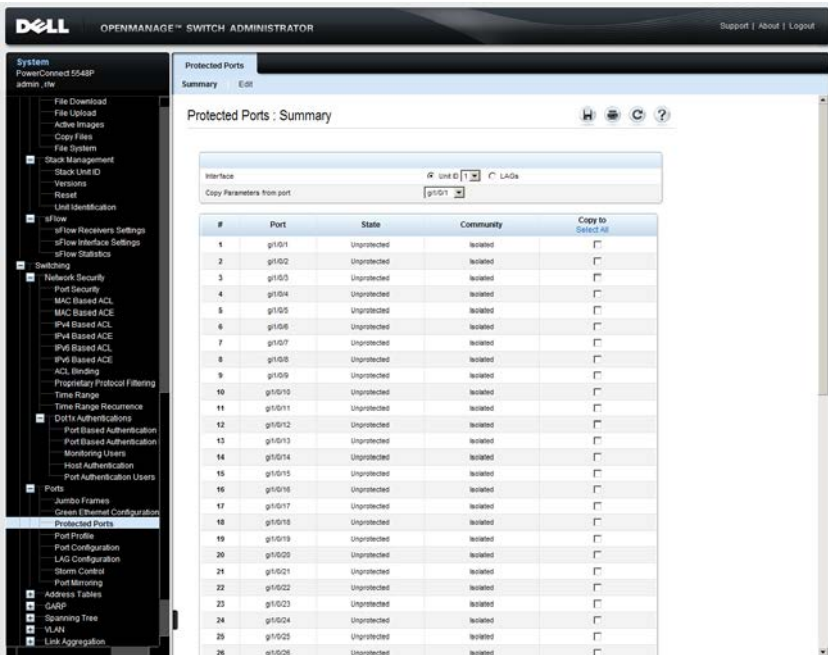

A summary of all the ports and their statuses is displayed.

- 2 Click **Edit**.
- 3 Select the unit and interface.
- 4 Enter values for the following fields:
 - **State** — Select **Protected/Unprotected** to enable/disable port protection.
 - **Community** — Select the community to which to add the port, or define the port as **Isolated**.

Configuring Protected Ports Using CLI Commands

The following table summarizes the CLI commands for configuring protected ports.

Table 10-4. Protected Ports CLI Commands

CLI Command	Description
switchport protected-port no switchport protected-port	Isolates Unicast, Multicast, and Broadcast traffic on a port at Layer 2 from other protected ports on the same switch. Use the no form of this command to disable protection on the port.
switchport community <i>community</i> no switchport community	Associates a protected port with a community. Use the no form of this command to return to default.
show interfaces protected-ports [<i>gigabitethernet tengigabitethernet</i>] <i>port-number</i>	Displays protected ports configuration.

The following is an example of the CLI commands:

```
console(config)# interface gil/0/3
console(config-if)# switchport protected-port
console(config-if)# switchport community 1
```

Port Profile

Port profiles provide a convenient way to save and share a port configuration. When a port profile, which is a set of CLI commands having a unique name, is applied to a port, the CLI commands contained within the profile (macro) are executed and added to the Running Configuration file.

Port profiles can be applied to a specific interface, a range of interfaces, or globally.

There are two types of port profiles:

- **User Defined** — Enables the user to bundle configurations, as a port profile, and then apply it to one or more interfaces at a time. Up to 20 user-defined macros can be supported. These can only be defined through CLI commands.
- **Built-In** — Pre-defined macros that cannot be changed or deleted. The device includes the following built-in macros:
 - Global
 - Desktop
 - Phone
 - Switch
 - Router
 - Wireless Configuration

Before a built-in profile can be applied to an interface, the global profile must be applied. The global profile enables QoS Advanced mode, sets Advanced mode parameters, CoS to queue mapping, and DSCP to queue mapping and defines certain standard ACLs. Use the CLI command **show parser macro name profile-global** to display the Global profile contents.

To assign a profile to a port:

- 1 Click **Switching > Ports > Port Profile** in the tree view to display the **Port Profiles: Summary** page.

Figure 10-4. Port Profile: Summary

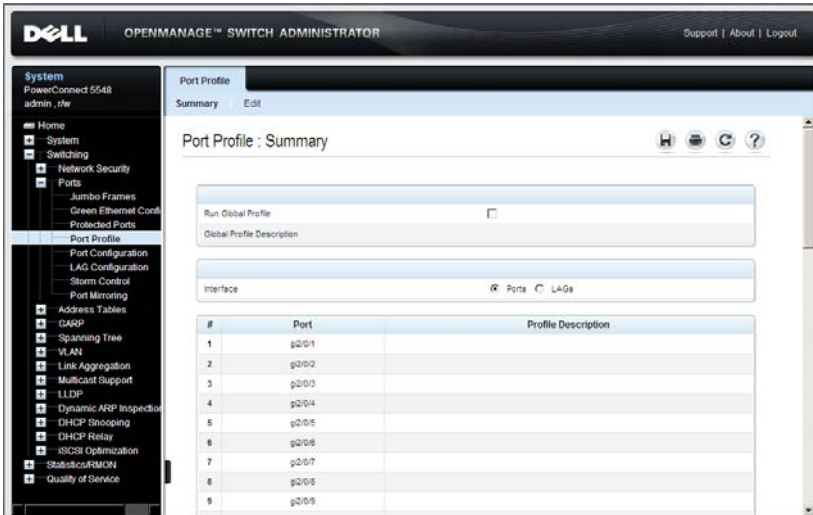

A summary of all the interfaces and their profiles is displayed.

- 2 To assign the **Global** profile to the system, check **Run Global Profile**. Apply the global profile before applying a built-in interface profile.
- 3 To assign a profile to an interface, click **Edit**.
- 4 Select a unit/interface and a **Assigned Profile**. The **Profile Description** is displayed.
- 5 Each profile requires entering various elements of VLAN information. Enter the fields according to the profile:
 - **VLAN Port Mode** — Displays the port mode applied to ports in the profile.
 - **VLAN ID-Untagged (1-4094)** — Enter the VLAN for untagged traffic.
 - **VLAN ID-Tagged (1-4095)** — Enter the VLAN for tagged traffic.

- **Native VLAN ID(1-4094)** — Enter the VLAN ID used for untagged traffic to trunk ports, or check **None**.

The remaining fields on this page are display-only, and describe the port configuration of the profile. The following fields are described:

Port Security fields:

- **Mode** — Learning mode. The possible options are:
 - **Classic Lock** — Locks the port using the classic lock mechanism. The port is immediately locked, regardless of the number of addresses that have already been learned.
 - **Limited Dynamic Lock** — Locks the port by deleting the dynamic MAC addresses associated with the port. The port learns up to the maximum addresses allowed on the port. Both relearning and aging MAC addresses are enabled.
- **Max Entries** — Displays the maximum number of MAC addresses that can be learned on the port.
- **Action on Violation** — Action to be applied to packets arriving on a locked port. The possible options are:
 - **Discard** — Discard the packets from any unlearned source.
 - **Forward** — Forward the packets from an unknown source, without learning the MAC address.
 - **Shutdown** — Discard the packet from any unlearned source, and shut down the port. Ports remain shutdown until they are reactivated, or the device is reset.

Spanning Tree fields:

- **Point-to-Point Admin Status** — Displays whether a point-to-point link is established. The possible options are:
 - **Enable** — Enables the device to establish a point-to-point link, or specifies for the device to automatically establish a point-to-point link. To establish communications over a point-to-point link, the originating PPP first sends Link Control Protocol (LCP) packets to configure and test the data link. After a link is established and optional facilities are negotiated as needed by the LCP, the originating PPP sends Network Control Protocols (NCP) packets to select and configure one or more network layer protocols.

When each of the chosen network layer protocols has been configured, packets from each network layer protocol can be sent over the link. The link remains configured for communications until explicit LCP or NCP packets close the link, or until some external event occurs. This is the actual switch port link type. It may differ from the administrative state.

- **Disable** — Disables point-to-point link.
- **Auto** — The device automatically establishes a point-to-point link.
- **Fast Link** — Displays whether Fast Link mode is enabled for the port. If this is enabled, the **Port State** is automatically placed in the **Forwarding** state when the port is up.
- **BPDU Guard** — Displays whether BPDU Guard is enabled on the port.

Miscellaneous fields:

- **Policy Name** — Displays the name of a policy if one is defined on the port.
- **Auto Negotiation** — Displays whether auto-negotiation is enabled on the port. Auto-Negotiation enables a port to advertise its transmission rate, duplex mode, and Flow Control abilities to other devices.

6 Click **Apply Profile** to apply the profile to the specified interface.

Configuring Port Profile Using CLI Commands

The following table summarizes the CLI commands for configuring port profiles.

Table 10-5. Port Profiles CLI Commands

CLI Command	Description
<code>macro {apply trace} <i>macro-name</i> [parameter {<i>value</i>}] [parameter {<i>value</i>}] [parameter {<i>value</i>}]</code>	Applies a macro to an interface or traces a macro configuration on an interface.

Table 10-5. Port Profiles CLI Commands (Continued)

CLI Command	Description
show parser macro [{ <i>brief</i> <i>description</i> [<i>interface</i> [<i>gigabitethernet</i> <i>tengigabitetherne</i> <i>t</i>] <i>port-number</i> <i>name</i> <i>macro-name</i> }]	Displays the parameters for all configured macros or for one macro on the switch.

The following is an example of the CLI commands:

```
Switch(config) # interface gil/0/2
Switch(config-if) # macro trace dup
Applying command... `duplex full'
Applying command... `speed auto'
Switch(config) # interface gil/0/2
Switch(config-if) # macro apply duplex $DUPLEX full
$SPEED auto
Switch(config-if) # exit
Switch(config) # interface gil/0/3
Switch(config-if) # macro apply dup
Switch(config-if) # exit
```

Sample CLI Scripts

This section provides sample scripts of CLI commands. These particular actions cannot be performed through the GUI, which only allows applying built-in macros. These scripts describe how to create macros, display them and apply them.

The following is a script that creates a global macro.

Table 10-6. Create a Global Macro Script

CLI Command	Description
console#config console(config)# macro name interswitch Enter macro commands one per line. End with the character '@'.	Create a macro called interswitch .

Table 10-6. Create a Global Macro Script (Continued)

CLI Command	Description
vlan database	Enter the commands in the macro, which create VLANs 40 through 50.
vlan 40-50	
@	
console(config)# do show parser macro name interswitch	Display the macro.
console(config)# macro global apply interswitch	Apply the macro.

The following is a script that creates an interface macro.

Table 10-7. Create an Interface Macro Script

CLI Command	Description
console# config	Enter Interface mode for ports 1-24 on unit 1.
console(config)# interface range gi1/0/1-24	
console(config-if-range)# macro name access_port	Create a macro called access_port .
Enter macro commands one per line. End with the character '@'.	
disable spanning-tree	Enter the commands in the macro, disables spanning tree on the interfaces.
@	
console(config)# do show parser macro name access_port	Display the macro.
console(config)# macro global apply access_port	Apply the macro to ports 1-24 on unit 1.

Port Configuration

If port configuration is modified while the port is a LAG member, the configuration change is only effective after the port is removed from the LAG.

To configure a port:

- 1 Click **Switching > Ports > Port Configuration** in the tree view to display the **Port Configuration: Summary** page.

Figure 10-5. Port Configuration: Summary

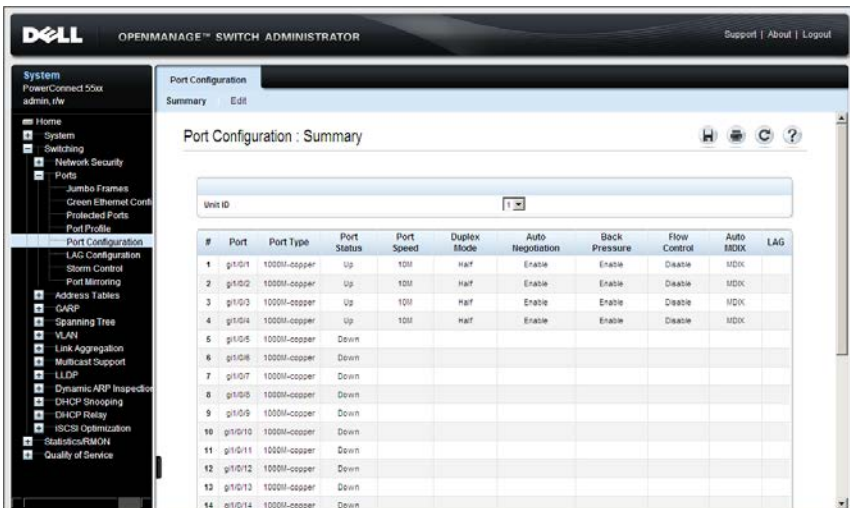

All ports on the selected unit and their configuration settings are displayed.

- 2 To modify the port settings, click **Edit** and select a port.
- 3 Enter the following fields:
 - **Description (1 - 64 Characters)** — Enter a user identification attached to the port.
 - **Port Type** — Displays the type of port.
 - **Admin Status** — Enable/disable traffic forwarding through the port.
 - **Up** — Traffic is enabled through the port.

- **Down** — Traffic is disabled through the port.
- **Current Port Status** — Displays whether the port is currently operational or non-operational.
- **Re-Activate Suspended Port** — Check to reactivate a port if the port has been disabled through the locked port security option.
- **Operational Status** — Displays the port operational status. The possible options are:
 - **Suspended** — Port is currently active, and is not receiving or transmitting traffic.
 - **Active** — Port is currently active, and is receiving and transmitting traffic.
 - **Disable** — Port is currently disabled, and is not receiving or transmitting traffic.
- **Admin Speed** — Select the configured rate for the port. The port type determines the available speed setting options. You can designate Administrative Speed only when port auto-negotiation is disabled.
- **Current Port Speed** — Displays the actual synchronized port speed (bps).
- **Admin Duplex** — Select the port duplex mode (this is only possible if Auto Negotiation is not enabled). The options are:
 - **Full** — The interface supports transmission between the device and the client in both directions simultaneously.
 - **Half** — The interface supports transmission between the device and the client in only one direction at a time.
- **Current Duplex Mode** — Displays the synchronized port duplex mode.
- **Auto Negotiation** — Select to enable auto-negotiation on the port. Auto-Negotiation enables a port to advertise its transmission rate, duplex mode, and Flow Control abilities to other devices.
 - **Energy Efficient Ethernet** — Globally enable/disable Energy Efficient Ethernet and the EEE LLDP advertisement feature.
- **Current Auto Negotiation** — Displays the current auto-negotiation setting.

- **Admin Advertisement** — Check the auto-negotiation setting the port advertises. The possible options are:
 - **Max Capability** — The port advertises all the options that it can support.
 - **10 Half** — The port advertises for a 10 mbps speed port and half duplex mode setting.
 - **10 Full** — The port advertises for a 10 mbps speed port and full duplex mode setting.
 - **100 Half** — The port advertises for a 100 mbps speed port and half duplex mode setting.
 - **100 Full** — The port advertises for a 100 mbps speed port and full duplex mode setting.
 - **1000 Full** — The port advertises for a 1000 mbps speed port and full duplex mode setting.
 - **10000 Full** — The port advertises for a 10000 mbps speed port and full duplex mode setting.
- **Current Advertisement** — Displays the port advertises its speed to its neighbor port to start the negotiation process. The possible field values are those specified in the **Admin Advertisement** field.
- **Neighbor Advertisement** — Displays the neighboring port's advertisement settings. The field values are identical to the **Admin Advertisement** field values.
- **Back Pressure** — Enable/disable Back Pressure mode that is used with Half Duplex mode to disable ports from receiving messages.
- **Current Back Pressure** — Displays the current Back Pressure setting.
- **Flow Control** — Set flow control on the port. The following options are available:
 - **Enable/Disable** — Enable/disable flow control on the port (Enabled is the default).
 - **Auto Negotiation** — Enables auto-negotiation of flow control on the port.
- **Current Flow Control** — Displays the current Flow Control setting.

- **MDI/MDIX** — Select one of the options that enables the device to decipher between crossed and uncrossed cables. Hubs and switches are deliberately wired opposite to the way end stations are wired, so that when a hub or switch is connected to an end station, a straight through Ethernet cable can be used, and the pairs are match up properly. When two hubs/switches are connected to each other, or two end stations are connected to each other, a crossover cable is used ensure that the correct pairs are connected. The possible options are:
 - **Auto** — Use to automatically detect the cable type.
 - **MDIX** — Use for hubs and switches.
 - **MDI** — Use for end stations.
- **Current MDI/MDIX** — Displays the current device MDIX settings.
- **LAG** — Displays whether the port is part of a LAG.

Configuring Ports Using CLI Commands

The following table summarizes the CLI commands for configuring ports as displayed in the **Port Configuration** pages.

Table 10-8. Port Configuration CLI Commands

CLI Command	Description
<code>eee enable</code>	Enables the EEE mode globally.
<code>no eee enable</code>	Use the no format of the command to disable the mode.
<code>eee lldp enable</code>	Enables EEE support by LLDP on an Ethernet port.
<code>no eee lldp enable</code>	Use the no format of the command to disable the support.
<code>description string</code>	Adds a description to an interface configuration.
<code>no description</code>	Use the no form of this command to remove the description.
<code>shutdown</code>	Disables an interfaces.
<code>no shutdown</code>	Use the no form of this command to restart a disabled interface.

Table 10-8. Port Configuration CLI Commands (Continued)

CLI Command	Description
set interface active { [<i>gigabitethernet</i> <i>tengigabitether-</i> <i>net</i>] <i>interface</i> / port-channel <i>LAG-</i> <i>number</i> }	Reactivates an interface that is shutdown.
speed { <i>10</i> <i>100</i> <i>1000</i> <i>10000</i> }	Configures the speed of a given Ethernet interface when not using auto negotiation.
no speed	Use the no form of this command to restore the default configuration.
duplex { <i>half</i> <i>full</i> }	Configures the full/half duplex operation of a given Ethernet interface when not using auto negotiation.
no duplex	
negotiation [<i>capability1</i> [<i>capability2...capability5</i>]	Enables auto negotiation operation for the speed and duplex parameters of a given interface.
no negotiation	Use the no form of this command to disable auto-negotiation.
back-pressure	Enables Back Pressure on a given interface.
no back-pressure	Use the no form of this command to disable back pressure.
flowcontrol { <i>auto</i> <i>on</i> <i>off</i> }	Configures the flow control on a given interface.
no flowcontrol	Use the no form of this command to disable flow control.
mdix { <i>on</i> <i>auto</i> }	Enables automatic crossover on a given interface or Port-channel.
no mdix	Use the no form of this command to disable cable crossover.
show interfaces configuration [[<i>gigabitethernet</i> <i>tengigabitether-</i> <i>net</i>] <i>port-number</i> port-channel <i>LAG-number</i>]	Displays the configuration for all configured interfaces.

Table 10-8. Port Configuration CLI Commands (Continued)

CLI Command	Description
show interfaces advertise	Displays the interface's negotiation advertisement settings.
show interfaces status [[<i>gigabitethernet</i> <i>tengigabitethernet</i>] <i>port-number</i> <i>port-channel</i> <i>LAG-number</i>]	Displays the status for all configured interfaces.
show interfaces description [[<i>gigabitethernet</i> <i>tengigabitethernet</i>] <i>port-number</i> <i>port-channel</i> <i>LAG-number</i>]	Displays the description for all configured interfaces.

The following is an example of the CLI commands:

```

console(config)# interface gi2/0/1
console(config-if)# description "RD SW#3"
console(config-if)# shutdown
console(config-if)# no shutdown
console(config-if)# speed 100
console(config-if)# duplex full
console(config-if)# negotiation
console(config-if)# back-pressure
console(config-if)# flowcontrol on
console(config-if)# mdix auto
console(config-if)# end
console# show interfaces configuration gi2/0/1
Port      Type      Duplex  Speed  Neg      Flow  Admin  Back  Mdix
-----  -
gi2/0/1  1G-Copper  Full    1000  Enabled  Off   Up     Disabled  Auto
console# show interfaces status gi2/0/1
Port      Type      Duplex  Speed  Neg      Flow Link  Back  Mdix
-----  -
gi2/0/1  1G-Copper  --      --     --      --  Down  --     --

```

LAG Configuration

Use the LAG Configuration pages to configure LAGs. The device supports up to 32 LAGs per system, meaning for all units in the stack. For information about Link Aggregated Groups (LAGs) and assigning ports to LAGs, see "Link Aggregation" on page 500.

To configure LAGs:

- 1 Click Switching > Ports > LAG Configuration in the tree view to display the LAG Configuration: Summary page.

Figure 10-6. LAG Configuration: Summary

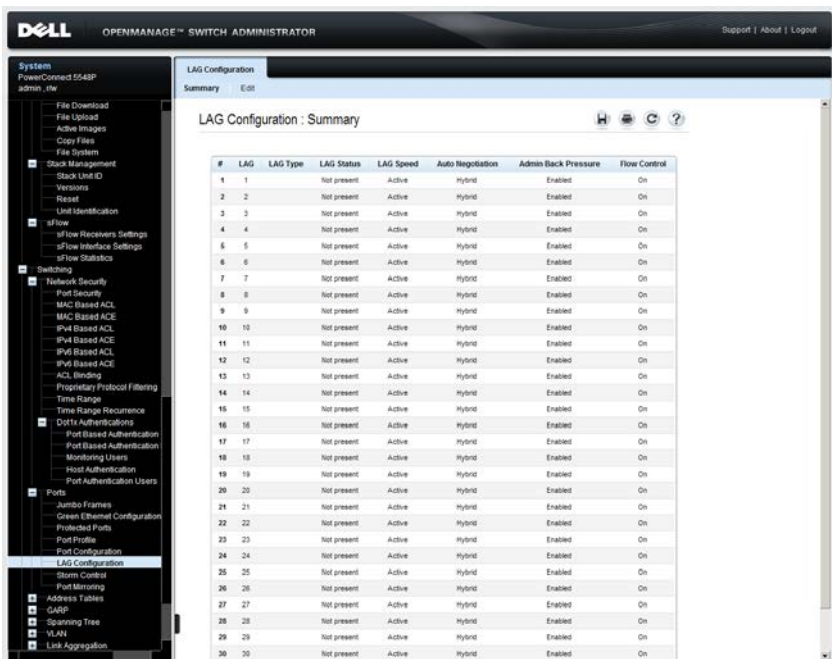

The LAG parameters are displayed.

- 2 To configure a LAG, click **Edit**.
- 3 Select the LAG and enter the fields:
 - **LAG Mode** — Select the LAG mode. The possible options are:

- **Static** — The ports comprise a single logical port for high-speed connections between networking devices.
 - **LACP** — Link Aggregate Control Protocol. LACP-enabled LAGs can exchange information with other links in order to update and maintain LAG configurations automatically.
- **Description (0 - 64 Characters)** — Enter a user-defined description of the configured LAG.
 - **LAG Type** — Displays the port types that comprise the LAG.
 - **Admin Status** — Enable/disable the selected LAG.
 - **Current Status** — Displays the LAG is currently operating.
 - **Admin Speed** — Select the configured speed at which the LAG is operating. The possible options are:
 - **10M** — The LAG is currently operating at 10 Mbps.
 - **100M** — The LAG is currently operating at 100 Mbps.
 - **1000M** — The LAG is currently operating at 1000 Mbps.
 - **10000 Full** — The LAG is currently operating at 1000 Mbps.
 - **Current Speed** — Displays the speed at which the LAG is currently operating.
 - **Admin Auto Negotiation** — Enable/disable auto-negotiation, which is a protocol between two link partners that enables a LAG to advertise its transmission rate, duplex mode and flow control abilities to its partner.
 - **Current Auto Negotiation** — Displays the current auto-negotiation setting.
 - **Admin Advertisement** — If auto-negotiation is enabled, select the auto-negotiation setting the LAG advertises. The possible options are:
 - **Max Capability** — All LAG speeds and Duplex mode settings are accepted.
 - **10 Full** — The LAG advertises for a 10 mbps speed LAG and full duplex mode setting.
 - **100 Full** — The LAG advertises for a 100 mbps speed LAG and full duplex mode setting.

- **1000 Full** — The LAG advertises for a 1000 mbps speed LAG and full duplex mode setting.
- **Current Advertisement** — Displays the speed that the LAG advertises to its neighbor LAG to start the negotiation process. The possible field values are those specified in the **Admin Advertisement** field.
- **Neighbor Advertisement** — Displays the neighboring LAG advertisement settings. The field values are identical to the **Admin Advertisement** field values.
- **Admin Flow Control** — Enable/disable flow control on the LAG. Flow Control mode is effective on the ports operating in Full Duplex in the LAG. The possible options are:
 - **Enable** — Enables flow control on the LAG (default).
 - **Disable** — Disables flow control on the LAG.
 - **Auto Negotiation** — Enables the auto-negotiation of flow control on the LAG.
- **Current Flow Control** — Displays the current Flow Control setting.

Configuring LAGs Using CLI Commands

The following table summarizes the CLI commands for configuring LAGs as displayed in the **LAG Configuration** pages.

Table 10-9. LAG Configuration CLI Commands

CLI Command	Description
interface <i>port-channel</i> <i>LAG-number</i>	Enters the interface configuration mode of a specific LAG.
channel-group <i>port-channel mode</i> { <i>on</i> <i>auto</i> }	Sets a mode for a LAG. Use the <i>no</i> form of this command to restore the default configuration.
no channel-group	
description <i>string</i>	Adds a description to a LAG.
no description	Use the <i>no</i> form of this command to remove the description.

Table 10-9. LAG Configuration CLI Commands (Continued)

CLI Command	Description
shutdown	Disables the LAG.
no shutdown	Use the no form of this command to restart the LAG.
speed {10 100 1000 10000}	Configures the speed of the LAG when not using auto negotiation.
no speed	Use the no form of this command to restore the default configuration.
negotiation [capability1 [capability2...capability5]	Enables auto negotiation operation for the speed and duplex parameters of a LAG.
no negotiation	Use the no form of this command to disable auto-negotiation.
flowcontrol {auto on off}	Configures the flow control on a given LAG.
no flowcontrol	Use the no form of this command to disable flow control.
show interfaces configuration [port-channel LAG-number]	Displays the configuration for the LAGs.
show interface advertise	Displays the LAG's negotiation advertisement settings.
show interfaces status [port- channel LAG-number]	Displays the status for all configured LAGs.
show interfaces description [port-channel LAG-number]	Displays the description for all configured LAGs.
show interfaces port-channel [LAG-number]	Displays LAG information.

The following is an example of the CLI commands:

```
console(config)# interface port-channel 1
console(config-if)# no negotiation
console(config-if)# speed 100
console(config-if)# flowcontrol on
console(config-if)# exit
console(config)# interface port-channel 2
console(config-if)# shutdown
console(config-if)# exit
console(config-if)# end
console# show interfaces port-channel
Channel          Ports
-----          -
ch1              Inactive: gi/1/0/(11-13)
ch2              Active: gi/1/0/14
```

Storm Control

When Broadcast, Multicast, or Unknown Unicast frames are received, they are duplicated, and a copy is sent to all possible egress ports. This means that in practice, they are sent to all ports belonging to the relevant VLAN. In this way, one ingress frame is turned into many, creating the potential for a storm.

Storm protection provides the ability to limit the number of frames entering the switch, and to define the types of frames that are counted towards this limit.

When a threshold (limit) is configured on the device, the port discards traffic when that threshold is reached. The port remains blocked until the traffic rate drops below this threshold. It then resumes normal forwarding.

To configure Storm Control:

- 1 Click **Switching > Ports > Storm Control** in the tree view to display the **Storm Control: Summary** page.

Figure 10-7. Storm Control

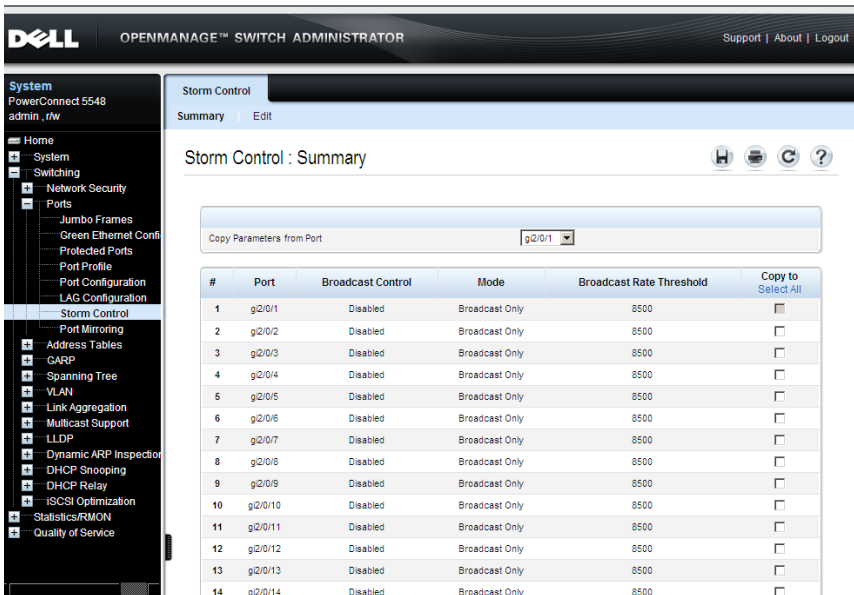

Storm control parameters are displayed for all ports on the selected unit.

- 2 To configure Storm Control on a port, click **Edit**.
- 3 Select a port from the Port drop-down list and enter the following fields:
 - **Broadcast Control** — Enable/disable forwarding Broadcast packets on the specific interface.
 - **Broadcast Mode** — Select the counting mode. The possible options are:
 - **Multicast & Broadcast** — Counts Broadcast and Multicast traffic together towards the bandwidth threshold.
 - **Broadcast Only** — Counts only Broadcast traffic towards the bandwidth threshold.
 - **Broadcast Rate Threshold (3500-1000000)** — Enter the maximum rate (Kbits/sec) at which unknown packets are forwarded.

Configuring Storm Control Using CLI Commands

The following table summarizes the CLI commands for configuring Storm Control as displayed on the **Storm Control** pages.

Table 10-10. Storm Control CLI Commands

CLI Command	Description
<code>storm-control include-multicast [unknown-unicast]</code>	Counts Multicast packets in the Broadcast storm control.
<code>no storm-control include-multicast</code>	Use the no form of this command to disable counting of multicast packets in the Broadcast storm control.
<code>storm-control broadcast enable</code>	Enables Broadcast storm control.
<code>no storm-control broadcast enable</code>	Use the no form of this command to disable Broadcast storm control.
<code>storm-control broadcast level kbps</code>	Configures the maximum Broadcast rate.
<code>no storm-control broadcast level</code>	Use the no form of this command to return the Broadcast level to the default value.

Table 10-10. Storm Control CLI Commands (Continued)

CLI Command	Description
<code>show ports storm-control port</code>	Displays the storm control configuration.

The following is an example of the CLI commands:

```
console(config)# interface gil/0/1
console(config-if)# storm-control broadcast enable
console(config-if)# storm-control include-multicast
unknown-unicast
console# show ports storm-control gil/0/1
Port      State      Rate [Kbits/Sec]  Included
-----
gil/0/1   Disabled   8500              Broadcast
```

Port Mirroring

Switches usually only forward frames to relevant ports. To monitor traffic, either for information gathering, such as statistical analysis, or for troubleshooting higher-layer protocol operation, the Mirroring feature forwards frames to a monitoring port.

Mirroring provides the ability to specify that a desired destination (target) port will receive a copy of all traffic passing through designated source ports.

The frames arriving at the destination port are copies of the frames passing through the source port at ingress, prior to any switch action.

It is possible to specify several source ports to be monitored by a single target port. However, in this case, the traffic sent to the target port is placed in the target port's queues on a first come, first served basis, and any excess traffic is silently discarded. This may mean that the traffic actually seen by any device attached to the target port is an arbitrarily selected subset of the actual traffic going through the source ports.

Port mirroring is only relevant to physical ports. Therefore, if you want a LAG to function as the source of a port mirroring session, the member ports must be individually specified as sources.

Up to eight sources can be mirrored. This can be any combination of eight individual ports.

Before configuring Port Mirroring, note the following:

- Monitored ports cannot operate faster than the monitoring port.
- All Rx/Tx packets should be monitored to the same port.

Destination Port Restrictions

The following restrictions apply to destination ports:

- Destination ports cannot be configured as source ports.
- Destination ports cannot be a member of a LAG.
- IP interfaces cannot be configured on the destination port.
- GVRP cannot be enabled on the destination port.
- The destination port cannot be a member of a VLAN.
- Only one destination port can be defined.

- All QoS/CoS rules that apply to the destination port, as an egress, such as traffic shaping, are suspended for the duration of the mirroring session. Any such settings, configured on the port during the mirroring session, take effect only after the port is no longer a destination port for a mirroring session.
- Ingress mirrored packets may arrive at the ingress port either with an 802.1q tag or without. When the packets are mirrored to a port analyzer, they should be transmitted as they are received on the ingress port. However, in the device, the packet is transmitted out of the port analyzer as always tagged or always untagged (user configurable), regardless of the input encapsulation.

Source Port Restrictions

The following restrictions apply to ports specified as source ports:

- Source ports cannot be a member of a LAG.
- Source ports cannot be configured as a destination port.
- Up to eight source ports can be mirrored.



NOTE: When a port is set to be a target port for a port-mirroring session, all normal operations on it are suspended. This includes Spanning Tree and LACP. All currently active protocols and services on that port are suspended.

Port Mirroring

To specify source and destination ports for port mirroring:

- 1 Click **Switching > Ports > Port Mirroring** in the tree view to display the **Port Mirroring: Summary** page.

Figure 10-8. Port Mirroring: Summary

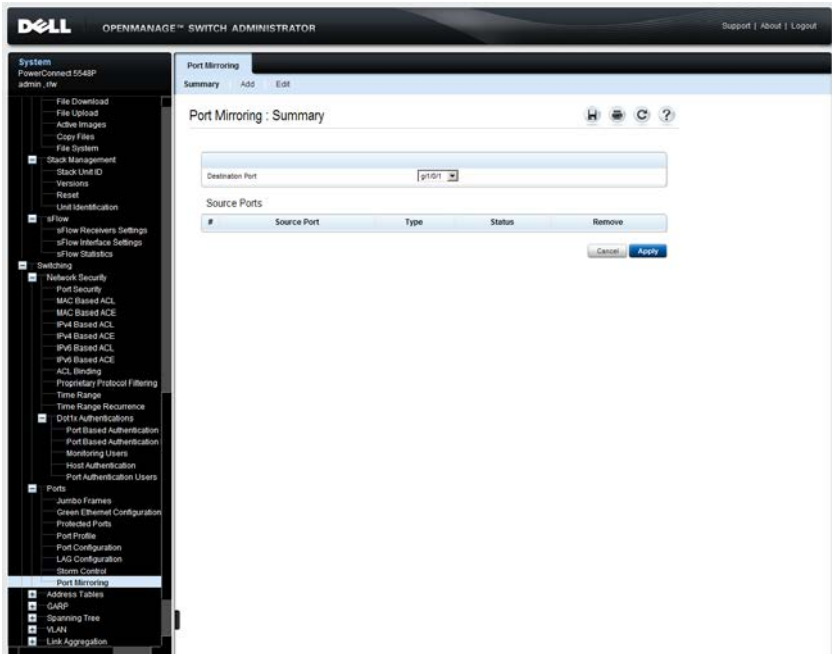

The previously-defined source ports for the selected **Destination Port** are displayed, along with the fields defined in the **Add** page and their status.

- **Status** — Indicates if the port is currently being monitored (**Active**) or not being monitored (**notReady**), because of some problem.
- 2 To add a port to be mirrored, click **Add**, and enter the fields:
 - **Source Port** — The port number from which port traffic is copied.
 - **Type** — Type of traffic (Tx or Rx or both) to be copied.

Configuring Port Mirroring Using CLI Commands

The following table summarizes the CLI commands for configuring Port Mirroring.

Table 10-11. Port Mirroring CLI Commands

CLI Command	Description
port monitor <i>src-interface-id</i> [rx tx]	Starts a port monitoring session. This must be performed in Interface Configuration mode, which is the destination interface.
no port monitor <i>src-interface-id</i>	Use the no form of this command to stop a port monitoring session.
show ports monitor	Displays the port monitoring status.

The following is an example of the CLI commands:

```
console(config)# interface gil/0/1
console(config-if)# port monitor gil/0/8
console# show ports monitor
Source port Destination Port    Type    Status
-----
gil/0/1    gil/0/8    RX, TX  Active
```

11

Address Tables

This section describes how MAC addresses are handled on the device.

It contains the following topics:

- Overview
- Static Addresses
- Dynamic Addresses

Overview

MAC addresses, associated with ports, are stored in the Static Address or the Dynamic Address tables. Packets, addressed to a destination stored in one of these tables, are forwarded to the associated port.

MAC addresses are dynamically learned when packets arrive at the device. Addresses are associated with ports by learning the source address of the frame. Frames, addressed to a destination MAC address that is not associated with any port, are flooded to all ports of the relevant VLAN. In order to prevent the bridging table from overflowing, dynamic MAC addresses, from which no traffic is seen for a certain period, are erased.

Static addresses are manually entered into the table.

Static Addresses

Static addresses are manually assigned to a specific interface and VLAN on the switch. If a static address is seen on another interface, the address is ignored and it is not written to the address table.

To define a static address:

- 1 Click **Switch > Address Tables > Static Address Table** in the tree view to display the **Static Address Table: Summary** page.

Figure 11-1. Static Address Table

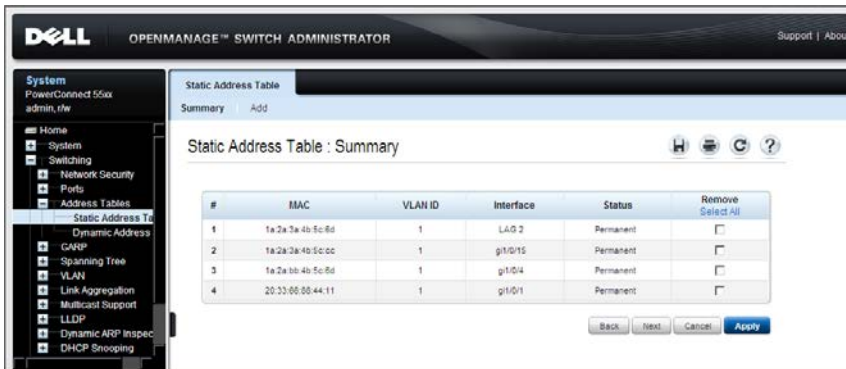

A list of the currently-defined static addresses is displayed.

- 2 To add a static address, click **Add**.
- 3 Enter the following fields:
 - **Interface** — Select a port or LAG for the entry.
 - **MAC Address** — Enter the interface MAC address.
 - **VLAN ID** — Check and select the VLAN ID for the port.or
 - **VLAN Name** — Check and enter the VLAN name.
 - **Status** — Select how the entry in the table will be treated. The possible options are:

- **Permanent** — The MAC address is never aged out of the table and, if it is saved to the Startup Configuration, it is retained after rebooting.
- **Delete on Reset** — The MAC address is deleted when the device is reset.
- **Delete on Timeout** — The MAC address is deleted when a timeout occurs.
- **Secure** — The MAC address is secure when the interface is in classic locked mode.

To prevent Static MAC addresses from being deleted when the Ethernet device is reset, ensure that the port attached to the MAC address is locked.

Configuring Static Addresses Using CLI Commands

The following table summarizes the CLI commands for configuring static address parameters as displayed in the **Static Address Table** pages.

Table 11-1. Static Address CLI Commands

CLI Command	Description
<code>mac address-table static mac-address vlan vlan-id interface { [gigabitethernet tengigabitethernet] port-number port-channel LAG-number } [permanent delete-on-reset delete-on-timeout secure]</code>	Adds a MAC-layer station source address to the MAC address table. Use the no form of this command to delete the MAC address.
<code>no mac address-table static [mac-address] vlan vlan-id</code>	
<code>show mac address-table [dynamic static secure] [vlan vlan]</code> <code>[[[gigabitethernet tengigabitethernet] port-number / port-channel LAG-number]] [address mac-address]</code>	Displays entries in the MAC address table.

The following is an example of the CLI commands:

```
console(config-if)#bridge address 00:60:70:4C:73:FF  
permanent gil/0/8  
console# show mac address-table static  
Aging time is 300 sec
```

VLAN	MAC Address	Port	Type
1	00:60:70:4C:73:FF	gil/0/8	static
1	00:60:70:8C:73:FF	gil/0/8	static
200	00:10:0D:48:37:FF	gil/0/9	static

Dynamic Addresses

The Dynamic Address Table contains the MAC addresses acquired by monitoring the source addresses of traffic entering the switch. When the destination address for inbound traffic is found in the database, the packets intended for that address are forwarded directly to the associated port. Otherwise, the traffic is flooded to all ports in the VLAN of the frame.

To prevent the table from overflowing and to make room for new addresses, an address is deleted from the table if no traffic is received from a dynamic MAC address for a certain period. This period of time is called the aging interval.

To configure dynamic addresses:

- 1 Click **Switch > Address Tables > Dynamic MAC Address** in the tree view to display the **Dynamic Address** page.

Figure 11-2. Dynamic Address Table

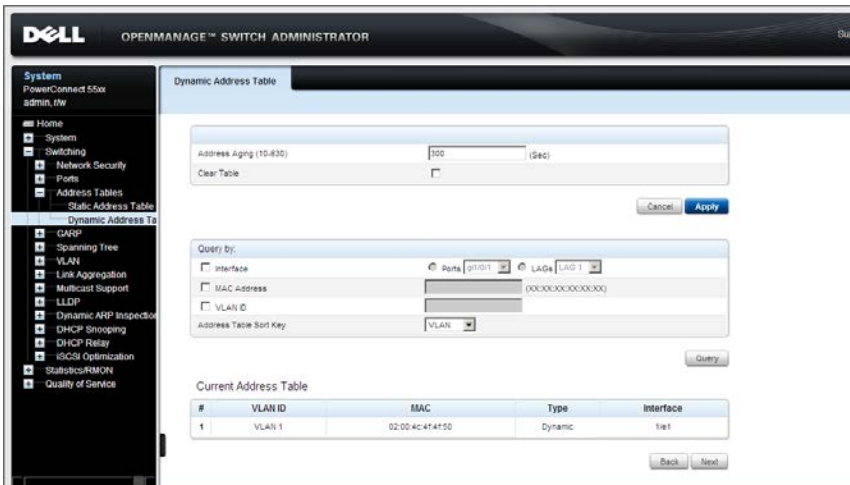

The current address table is displayed along with other parameters.

- 2 Enter **Address Aging (10-630)**. The aging time is a value between the user-configured value and twice that value minus 1. For example, if you entered 300 seconds, the aging time is between 300 and 599 seconds.

- 3 To clear the table, check **Clear Table**.
- 4 To display a subset of the addresses in a particular order, enter the query criteria and sort key under **Query By**, and click **Query**. The following fields are displayed for entries matching the query criteria:
 - **VLAN ID** — VLAN ID in the entry.
 - **MAC Address** — Interface MAC address.
 - **Interface** — Port or LAG associated with the MAC address.

Configuring Dynamic Addresses Using CLI Commands

The following table summarizes the CLI commands for configuring static address parameters as displayed in the **Dynamic Address Table** pages.

Table 11-2. Dynamic Address CLI Commands

CLI Command	Description
<code>mac address-table aging-time seconds</code>	Sets the aging time of the address table.
<code>no mac address-table aging-time</code>	Use the no form of this command to restore the default.
<code>clear mac address-table dynamic [interface [{gigabitethernet tengigabitethernet} port-number port-channel LAG-number]} [permanent delete-on-reset delete-on-timeout secure]</code>	Removes learned or secure entries from the forwarding database.
<code>clear mac address-table secure interface [gigabitethernet tengigabitethernet] port-number port-channel LAG-number</code>	
<code>show mac address-table [dynamic static secure] [vlan vlan] [interface [gigabitethernet tengigabitethernet] port-number port-channel LAG-number] [address mac-address]</code>	Displays entries in the MAC address table.

The following is an example of the CLI commands:

```
console(config)# mac address-table aging-time 600
console# show mac address-table dynamic
Aging time is 300 sec
VLAN      MAC Address                Port      Type
----      -
1         00:60:70:4C:73:FF         gil/0/8   dynamic
1         00:60:70:8C:73:FF         gil/0/8   dynamic
```

12

GARP

This section describes how to configure Generic Attribute Registration Protocol (GARP) on the device.

It contains the following topics:

- GARP Overview
- GARP Timers

GARP Overview

Generic Attribute Registration Protocol (GARP) is a general-purpose protocol that registers network connectivity or membership-style information. GARP defines a set of devices interested in a given network attribute, such as VLAN or Multicast address.

The Generic Attribute Registration Protocol (GARP) provides a generic framework whereby devices in a bridged LAN, such as end stations and switches, can register and de-register attribute values, such as VLAN Identifiers, with each other. In doing so, these attributes are propagated to devices in the bridged LAN, and these devices form a reachability tree that is a subset of an active topology. GARP defines the architecture, rules of operation, state machines and variables for the registration and deregistration of attribute values.

When configuring GARP, ensure the following:

- The leave time must be greater than or equal to three times the join time.
- The leave-all time must be greater than the leave time.
- Set the same GARP timer values on all Layer 2-connected devices. If the GARP timers are set differently on the Layer 2-connected devices, GARP application does not operate successfully.

GARP Timers

To enable a GARP timer on an interface:

- 1 Click **Switching > GARP > GARP Timers** in the tree view to open the **GARP Timers: Summary** page.

Figure 12-1. GARP Timers: Summary

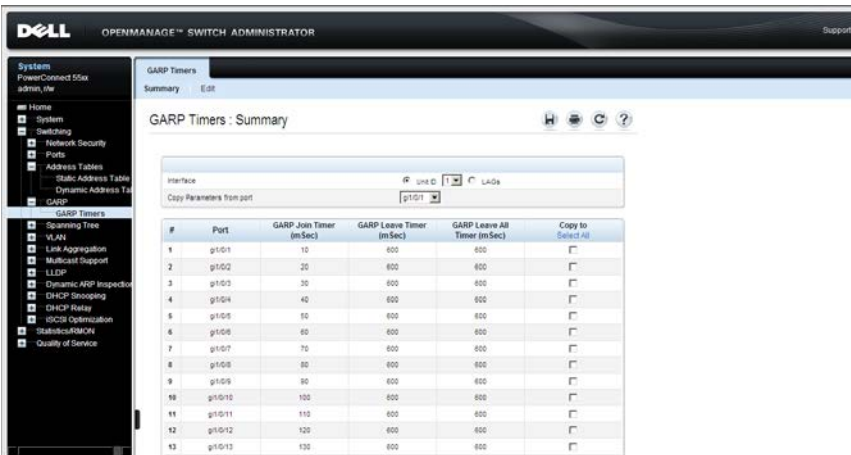

The GARP timers are displayed.

- 2 Click **Edit**.
- 3 Select an interface, and enter the fields:
 - **GARP Join Timer (10 - 2147483640)** — Enter the time, in milliseconds, during which Protocol Data Units (PDU) are transmitted.
 - **GARP Leave Timer (10 - 2147483640)** — Enter the time interval, in milliseconds, which the device waits before leaving its GARP state. Leave time is activated by a Leave All Time message sent/received, and cancelled by the Join message received. Leave time must be greater than or equal to three times the join time.
 - **GARP Leave All Timer (10 - 2147483640)** — Enter time interval, in milliseconds, which all devices wait before leaving the GARP state. The leave all time must be greater than the leave time.

Defining GARP Timers Using CLI Commands

This table summarizes the CLI commands for defining GARP timers as displayed in the GARP Timers pages.

Table 12-1. GARP Timer CLI Commands

CLI Command	Description
<code>garp timer {join leave leaveall} timer_value</code>	Adjusts the GARP application join, leave, and leaveall GARP timer values.
<code>show gvrp configuration</code> [[<code>gigabitethernet</code> <code>tengigabitethernet</code>] <code>port-number</code> <code>vlan</code> <code>vlan-id</code> <code>port-channel</code> <code>LAG-number</code>]	Displays GVRP configuration information, including timer values, whether GVRP and dynamic VLAN creation are enabled, and which ports are running GVRP.

The following is an example of the CLI commands:

```

console(config)# interface gil/0/1
console(config-if)# garp timer leave 900
console(config-if)# end
console# show gvrp configuration gil/0/11
GVRP Feature is currently Disabled on the device.
Maximum VLANs: 223
Port(s)    GVRP      Registration  Dynamic VLAN  Timers (milliseconds)
           Status           Creation      Join    Leave    Leave All
-----  -
gil/0/11  Disabled  Normal       Enabled    200    900    10000

```

13

Spanning Tree

This chapter describes the Spanning Tree Protocol.

It contains the following topics:

- Spanning Tree Protocol Overview
- Global Settings
- STP Port Settings
- STP LAG Settings
- Rapid Spanning Tree
- Multiple Spanning Tree

Spanning Tree Protocol Overview

Spanning Tree Protocol (STP) provides tree topography for any bridge arrangement. STP eliminates loops by providing a unique path between end stations on a network.

Loops occur when alternate routes exist between hosts. Loops, in an extended network, can cause bridges to forward traffic indefinitely, resulting in packets not arriving at their destination, increased traffic, and reduced network efficiency.

The device supports the following Spanning Tree versions:

- **Classic STP** — Provides a single path between end stations, avoiding and eliminating loops. For more information on configuring Classic STP, see "Global Settings" on page 431.
- **Rapid STP (RSTP)** — Provides faster convergence of the spanning tree than Classic STP. RSTP is most effective when the network topology is naturally tree-structured, and therefore faster convergence might be possible. RSTP is enabled by default.

Although Classic STP is guaranteed to prevent Layer 2 forwarding loops, in a general network topology, there might be an unacceptable delay before convergence. This means that before convergence, each bridge or switch in the network must decide if it should actively forward traffic or not, on each of its ports.

For more information on configuring Rapid STP, see "**Rapid Spanning Tree**" on page 444.

- **Multiple STP (MSTP)** — MSTP is based on RSTP. It detects Layer 2 loops, and attempts to mitigate them by preventing the involved port from transmitting traffic.

Since loops exist on a per-Layer 2-domain basis, a situation can occur where there is a loop in VLAN A and no loop in VLAN B. If both VLANs are on Port X, and STP wants to mitigate the loop, it stops traffic on the entire port, including VLAN B traffic, where there is no need to stop traffic.

Multiple Spanning Tree Protocol (MSTP) solves this problem by enabling several STP instances, so that it is possible to detect and mitigate loops separately in each instance. By associating instances to VLANs, each

instance is associated with the Layer 2 domain on which it performs loop detection and mitigation. This enables a port to be stopped in one instance, such as traffic from VLAN A that is causing a loop, while traffic can remain active in another domain where no loop was seen, such as on VLAN B.

MSTP provides full connectivity for packets allocated to any VLAN, and transmits packets assigned to various VLANs, through different multiple spanning tree (MST) regions.

MST regions act as a single bridge.

For more information on configuring Multiple STP, see "**Multiple Spanning Tree**" on page 448.

Global Settings

To enable STP and select the STP mode on the device:

- 1 Click **Switching > Spanning Tree > Global Settings** in the tree view to display the **Global Settings** page.

Figure 13-1. Global Settings

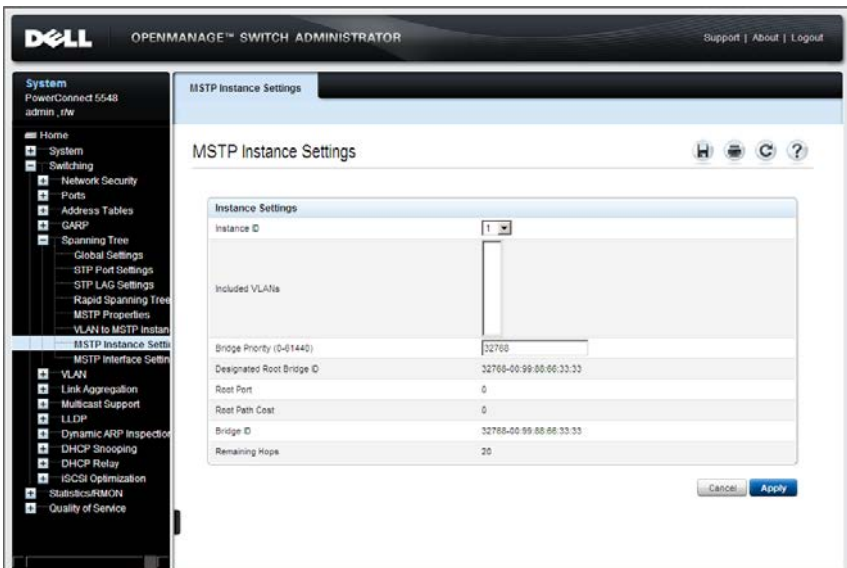

The currently-defined settings are displayed.

- 2 Enter the fields:

- **Spanning Tree State** — Enable Spanning Tree on the device.
- **STP Operation Mode** — Select the STP mode enabled on the device.

The possible options are:

- **Classic STP** — Enables Classic STP on the device.
- **Rapid STP** — Enables Rapid STP on the device. This is the default value.
- **Multiple STP** — Enables Multiple STP on the device.

- **BPDU Handling** — Select how Bridge Protocol Data Unit (BPDU) packets are managed when STP is disabled on the port/device. BPDUs are used to transmit spanning tree information. The possible options are:
 - **Filtering** — Filter BPDU packets when spanning tree is disabled on an interface.
 - **Flooding** — Flood BPDU packets when spanning tree is disabled on an interface.
- **Path Cost Default Values** — Select the method used to assign default path costs to STP ports. The possible options are:
 - **Short** — Specifies 1 through 65,535 range for port path costs.
 - **Long** — Specifies 1 through 200,000,000 range for port path costs.

The default path costs assigned to an interface vary according to the selected method:

Interface	Long Cost	Short Cost
LAG	20,000	4
1000 Mbps	20,000	4
100 Mbps	200,000	19
10 Mbps	2,000,000	100

Bridge Settings

- **Priority (0-61440 in steps of 4096)** — Enter the bridge priority value. When switches or bridges are running STP, each is assigned a priority. After exchanging BPDUs, the device with the lowest priority value becomes the Root Bridge. The default value is 32768. The port priority value is provided in increments of 4096. For example, 4096, 8192, 12288, etc.
- **Hello Time (1-10)** — Check to use the device Hello Time, which is the interval of time in seconds that a root bridge waits between configuration messages. Enter a value.
- **Max Age (6-40)** — Check to use device Maximum Age Time, which is the time interval in seconds that a bridge waits before sending configuration messages. Enter a value.

- **Forward Delay (4-30)** — Check to use device forward delay time, which is the interval of time in seconds that a bridge remains in a listening and learning state before forwarding packets. Enter a value.

Designated Root — Displays the following:

- **Bridge ID** — The bridge priority and MAC address.
- **Root Bridge ID** — The root bridge priority and MAC address.
- **Root Port** — The port number that offers the lowest cost path from this bridge to the Root Bridge. This is significant when the Bridge is not the Root.
- **Root Path Cost** — The cost of the path from this bridge to the root.
- **Topology Changes Counts** — The total amount of STP state changes that have occurred.
- **Last Topology Change** — The amount of time that has elapsed since the bridge was initialized or reset, and the last topographic change occurred.

Defining STP Global Parameters Using CLI Commands

The following table summarizes the CLI commands for defining STP global parameters as displayed in the **Global Settings** pages.

Table 13-1. STP Global Parameter CLI Commands

CLI Command	Description
<code>spanning-tree</code>	Enables spanning tree functionality.
<code>no spanning-tree</code>	Use the no form of this command to disable the spanning-tree functionality.
<code>spanning-tree mode {stp rstp mstp}</code>	Configures the mode of the spanning tree protocol.
<code>no spanning-tree mode</code>	Use the no form of this command to restore the default configuration.
<code>spanning-tree bpdu {filtering flooding bridging}</code>	Defines BPDU handling when the spanning tree is disabled globally or on a single interface.
<code>no spanning-tree bpdu</code>	Use the no form of this command to restore the default configuration.

Table 13-1. STP Global Parameter CLI Commands (Continued)

CLI Command	Description
spanning-tree pathcost method <i>{long short}</i>	Sets the default path cost method.
no spanning-tree pathcost method	Use the no form of this command to return to the default configuration.
spanning-tree priority <i>priority</i>	Configures the spanning tree priority.
no spanning-tree priority	Use the no form of this command to restore the default device spanning-tree priority.
spanning-tree hello-time <i>seconds</i>	Configures the spanning tree bridge Hello Time, which is how often the device Broadcasts Hello messages to other devices.
no spanning-tree hello-time	Use the no form of this command to restore the default configuration.
spanning-tree max-age <i>seconds</i>	Configures the spanning tree bridge maximum age.
no spanning-tree max-age <i>seconds</i>	Use the no form of this command to restore the default configuration
spanning-tree forward-time <i>seconds</i>	Configures the spanning tree bridge forward time, which is the amount of time a port remains in the listening and learning states before entering the forwarding state.
no spanning-tree forward-time	Use the no form of this command to restore the default configuration.
show spanning-tree <i>[[gigabitethernet tengigabite thernet] port-number/port- channel LAG-number] [instance instance-id]</i>	Displays spanning tree configuration.
show spanning-tree [<i>detail</i>] <i>[active blockedports]</i> <i>[instance instance-id]</i>	Displays detailed spanning tree information on active or blocked ports.
show spanning-tree mst-configuration	Displays spanning tree MST configuration identifier.

The following is an example of the CLI commands:

```
console(config)# spanning-tree  
console(config)# spanning-tree mode rstp  
console(config)# spanning-tree priority 12288  
console(config)# spanning-tree hello-time 5  
console(config)# spanning-tree max-age 12  
console(config)# spanning-tree forward-time 25  
console(config)# exit
```

STP Port Settings

To assign STP properties to individual ports:

- 1 Click **Switching > Spanning Tree > STP Port Settings** in the tree view to display the **STP Port Settings: Summary** page.

Figure 13-2. STP Port Settings: Summary

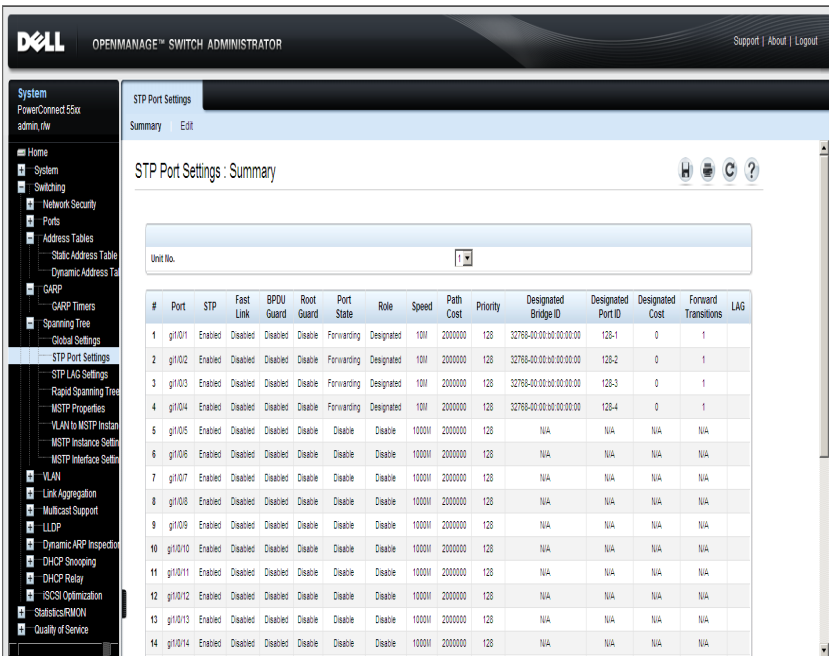

The ports and their STP settings are displayed.

- 2 To modify STP settings on a port, click **Edit**.
- 3 Select the port, and enter the fields:
 - **STP** — Enable/disable STP on the port.
 - **Fast Link** — Check to enable Fast Link mode for the port. If this is enabled, the **Port State** is automatically placed in the **Forwarding** state when the port is up. Fast Link mode optimizes the time it takes for the STP protocol to converge. STP convergence can take 30-60 seconds in large networks.

- **BPDU Guard** — Check to enable BPDU Guard on the port.
- **Root Guard** — Check to prevent devices outside the network core from being assigned the spanning tree root.
- **Port State** — Displays the current STP state of a port. If the port state is not disabled, it determines what forwarding action is taken on traffic. The possible port states are:
 - **Disabled** — STP is currently disabled on the port. The port forwards traffic while learning MAC addresses.
 - **Blocking** — The port is currently blocked and cannot be used to forward traffic or learn MAC addresses. Blocking is displayed when Classic STP is enabled.
 - **Listening** — The port is currently in the listening mode. The port cannot forward traffic nor can it learn MAC addresses.
 - **Learning** — The port is currently in the learning mode. The port cannot forward traffic, however it can learn new MAC addresses.
 - **Forwarding** — The port is currently in the forwarding mode. The port can forward traffic and learn new MAC addresses.
- **Role** — Displays the port role assigned by the STP algorithm that provides STP paths. The possible options are:
 - **Root** — This port provides the lowest cost path to forward packets to root switch.
 - **Designated** — This port is the interface through which the bridge is connected to the LAN, which provides the lowest cost path from the LAN to the Root Bridge.
 - **Alternate** — This port provides an alternate LAG to the root switch from the root interface.
 - **Backup** — This port provides a backup path to the designated port. Backup ports occur only when two ports are connected in a loop by a point-to-point link. Backup ports also occur when a LAN has two or more connections connected to a shared segment.
 - **Disabled** — This port is not participating in the Spanning Tree.

- **Speed** — Displays the speed at which the port is operating.
- **Path Cost (1-200000000)** — Enter the port contribution to the root path cost. The path cost is adjusted to a higher or lower value, and is used to forward traffic when a path being rerouted.
- **Default Path Cost** — Check to use the default path cost.
- **Priority** — Select the priority value that influences the port choice when a bridge has two ports connected in a loop. The priority value is provided in increments of 16.
- **Designated Bridge ID** — Displays the bridge priority and the MAC address of the designated bridge.
- **Designated Port ID** — Displays the designated port’s priority and interface.
- **Designated Cost** — Displays the cost of the port participating in the STP topology. Ports with a lower cost are less likely to be blocked if STP detects loops.
- **Forward Transitions** — Displays the number of times the port has changed from the **Forwarding** state to **Blocking**.
- **LAG** — Displays the LAG to which the port is attached.

Defining STP Port Settings Using CLI Commands

The following table summarizes the CLI commands for defining STP port parameters as displayed in the **STP Port Settings** page.

Table 13-2. STP Port Settings CLI Commands

CLI Command	Description
<code>spanning-tree disable</code>	Disables spanning tree on a specific port.
<code>no spanning-tree disable</code>	Use the no form of this command to enable the spanning tree on a port.
<code>spanning-tree cost cost</code>	Configures the spanning tree cost contribution of a port
<code>no spanning-tree cost</code>	Use the no form of this command to restore the default configuration.

Table 13-2. STP Port Settings CLI Commands (Continued)

CLI Command	Description
spanning-tree port-priority <i>priority</i>	Configures port priority.
no spanning-tree port-priority	Use the no form of this command to restore the default configuration.
show spanning-tree [[<i>gigabitethernet</i> <i>tengigabitethernet</i>] <i>port-number</i> port-channel <i>LAG-number</i>] [<i>instance instance-id</i>]	Displays spanning tree configuration.
spanning-tree portfast	Enables Fast Link mode.
no spanning-tree portfast	Use the no form of this command to disable the PortFast mode.
spanning-tree bpduguard { <i>enable</i> <i>disable</i> }	Shuts down an interface when it receives a bridge protocol data unit (BPDU).
no spanning-tree bpduguard	Use the no form of this command to restore the default configuration.
spanning-tree guard root	Enables root guard on all spanning tree instances on the interface.
show spanning-tree [<i>detail</i>] [<i>active</i> <i>blockedports</i>] [<i>instance instance-id</i>]	Displays detailed spanning tree information on active or blocked ports.

The following is an example of the CLI commands:

```
console> enable
console# configure
console(config)# interface gil/0/1
console(config-if)# spanning-tree enable
console(config-if)# spanning-tree cost 35000
console(config-if)# spanning-tree port-priority 96
console(config-if)# spanning-tree portfast
console(config-if)# exit
console(config)# exit
console# show spanning-tree gil/0/15 instance 12
Port gil/0/15 enabled
State: discarding                               Role: alternate
Port ID: 128.15                                 Port cost: 19
Type: P2p (configured: Auto) Internal Port Fast: No
(configured: No)
Designated bridge Priority :                    Address:
32768                                           00:00:b0:07:07:49
Designated port ID: 128.11                      Designated path cost: 0
Guard root: Disabled
Number of transitions to forwarding state: 3
BPDU: sent 482, received 1035
```

STP LAG Settings

To assign STP parameters to LAGs:

- 1 Click **Switching > Spanning Tree > LAG Settings** in the tree view to display the **STP LAG Settings: Summary** page.

Figure 13-3. STP LAG Settings: Summary

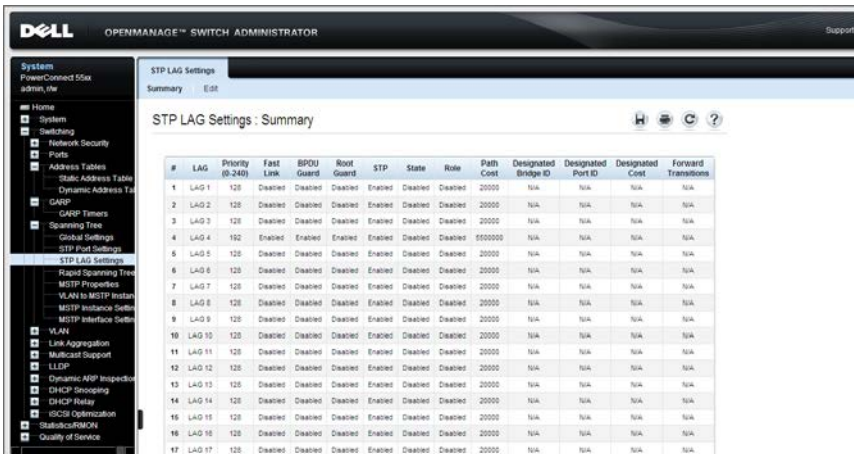

#	LAG	Priority (0-240)	Fast Link	BPDU Guard	Root Guard	STP	State	Role	Path Cost	Designated Bridge ID	Designated Port ID	Designated Cost	Forward Transitions
1	LAG 1	128	Disabled	Disabled	Disabled	Enabled	Disabled	Disabled	20000	N/A	N/A	N/A	N/A
2	LAG 2	128	Disabled	Disabled	Disabled	Enabled	Disabled	Disabled	20000	N/A	N/A	N/A	N/A
3	LAG 3	128	Disabled	Disabled	Disabled	Enabled	Disabled	Disabled	20000	N/A	N/A	N/A	N/A
4	LAG 4	192	Enabled	Enabled	Enabled	Enabled	Disabled	Disabled	5000000	N/A	N/A	N/A	N/A
5	LAG 5	128	Disabled	Disabled	Disabled	Enabled	Disabled	Disabled	20000	N/A	N/A	N/A	N/A
6	LAG 6	128	Disabled	Disabled	Disabled	Enabled	Disabled	Disabled	20000	N/A	N/A	N/A	N/A
7	LAG 7	128	Disabled	Disabled	Disabled	Enabled	Disabled	Disabled	20000	N/A	N/A	N/A	N/A
8	LAG 8	128	Disabled	Disabled	Disabled	Enabled	Disabled	Disabled	20000	N/A	N/A	N/A	N/A
9	LAG 9	128	Disabled	Disabled	Disabled	Enabled	Disabled	Disabled	20000	N/A	N/A	N/A	N/A
10	LAG 10	128	Disabled	Disabled	Disabled	Enabled	Disabled	Disabled	20000	N/A	N/A	N/A	N/A
11	LAG 11	128	Disabled	Disabled	Disabled	Enabled	Disabled	Disabled	20000	N/A	N/A	N/A	N/A
12	LAG 12	128	Disabled	Disabled	Disabled	Enabled	Disabled	Disabled	20000	N/A	N/A	N/A	N/A
13	LAG 13	128	Disabled	Disabled	Disabled	Enabled	Disabled	Disabled	20000	N/A	N/A	N/A	N/A
14	LAG 14	128	Disabled	Disabled	Disabled	Enabled	Disabled	Disabled	20000	N/A	N/A	N/A	N/A
15	LAG 15	128	Disabled	Disabled	Disabled	Enabled	Disabled	Disabled	20000	N/A	N/A	N/A	N/A
16	LAG 16	128	Disabled	Disabled	Disabled	Enabled	Disabled	Disabled	20000	N/A	N/A	N/A	N/A
17	LAG 17	128	Disabled	Disabled	Disabled	Enabled	Disabled	Disabled	20000	N/A	N/A	N/A	N/A

The LAGs and their STP settings are displayed.

- 2 To modify STP settings on a LAG, click **Edit**.
- 3 Select a LAG from the **Select a LAG** drop-down menu.
- 4 Enter the fields.
 - **STP** — Enable/disable STP on the LAG.
 - **Fast Link** — Check to enable Fast Link mode for the LAG. If Fast Link mode is enabled for a LAG, the **LAG State** is automatically placed in **Forwarding** when the LAG is up. Fast Link mode optimizes the time it takes for the STP protocol to converge. STP convergence can take from 30-60 seconds in large networks.
 - **BPDU Guard** — Check to enable BPDU Guard on the LAG.
 - **Root Guard** — Check to prevent devices outside the network core from being assigned the spanning tree root.

- **LAG State** — Displays the current STP state of the LAG. If enabled, the LAG state determines what forwarding action is taken on traffic. If the bridge discovers a malfunctioning LAG, the LAG is placed in the **Broken** state. Possible LAG states are:
 - **Disabled** — STP is currently disabled on the LAG. The LAG forwards traffic while learning MAC addresses.
 - **Blocking** — The LAG is blocked and cannot be used to forward traffic or learn MAC addresses.
 - **RSTP Discarding State** — The LAG does not learn MAC addresses and does not forward frames. This state is union of Blocking and Listening state introduced in STP (802.1.D).
 - **Listening** — The LAG is in the listening mode, and cannot forward traffic or learn MAC addresses.
 - **Learning** — The LAG is in the learning mode, and cannot forward traffic, but it can learn new MAC addresses.
 - **Forwarding** — The LAG is currently in the forwarding mode, and it can forward traffic and learn new MAC addresses.
 - **Broken** — The LAG is currently malfunctioning, and cannot be used for forwarding traffic.
- **Role** — Displays the LAG role assigned by the STP algorithm that provides STP paths. The possible options are:
 - **Root** — This LAG provides the lowest cost path to forward packets to root switch.
 - **Designated** — This LAG is the interface through which the bridge is connected to the LAN, which provides the lowest cost path from the LAN to the Root Bridge.
 - **Alternate** — This LAG provides an alternate LAG to the root switch from the root interface.
 - **Backup** — This LAG provides a backup path to the designated port. Backup ports occur only when two ports are connected in a loop by a point-to-point link. Backup ports also occur when a LAN has two or more connections connected to a shared segment.
 - **Disabled** — This LAG is not participating in the Spanning Tree.

- **Path Cost (1-200000000)** — Enter the amount the LAG contributes to the root path cost. The path cost is adjusted to a higher or lower value, and is used to forward traffic when a path is being rerouted. The path cost has a value of 1 to 200000000.
- **Default Path Cost** — Check for the device to use the default path cost.
- **Priority** — Select the priority value of the LAG. The priority value influences the LAG choice when a bridge has looped ports. The priority value is given in steps of 16.
- **Designated Bridge ID** — Displays the priority and the MAC address of the designated bridge.
- **Designated Port ID** — Displays the ID of the selected interface.
- **Designated Cost** — Displays the cost of the port participating in the STP topology. Ports with a lower cost are less likely to be blocked if STP detects loops.
- **Forward Transitions** — Displays the number of times the **LAG State** has changed from the **Forwarding** state to a **Blocking state**.

Defining STP LAG Settings Using CLI Commands

For information about CLI commands for defining STP LAG settings, see Table 15-2.

The following is an example of the CLI commands:

```
console(config)# interface port-channel 1
console(config-if)# spanning-tree disable
console(config-if)# spanning-tree cost 35000
console(config-if)# spanning-tree port-priority 96
console(config-if)# spanning-tree portfast
```

Rapid Spanning Tree

While classic spanning tree prevents Layer 2 forwarding loops on a general network topology, convergence can take from 30 to 60 seconds. This delay provides time to detect possible loops, and propagate status changes.

Rapid Spanning Tree Protocol (RSTP) detects and uses network topologies that enable a faster convergence of the spanning tree, without creating forwarding loops.

To configure RSTP:

- 1 Click **Switching > Spanning Tree > Rapid Spanning Tree** in the tree view to display the **Rapid Spanning Tree: Summary** page.

Figure 13-4. Rapid Spanning Tree: Summary

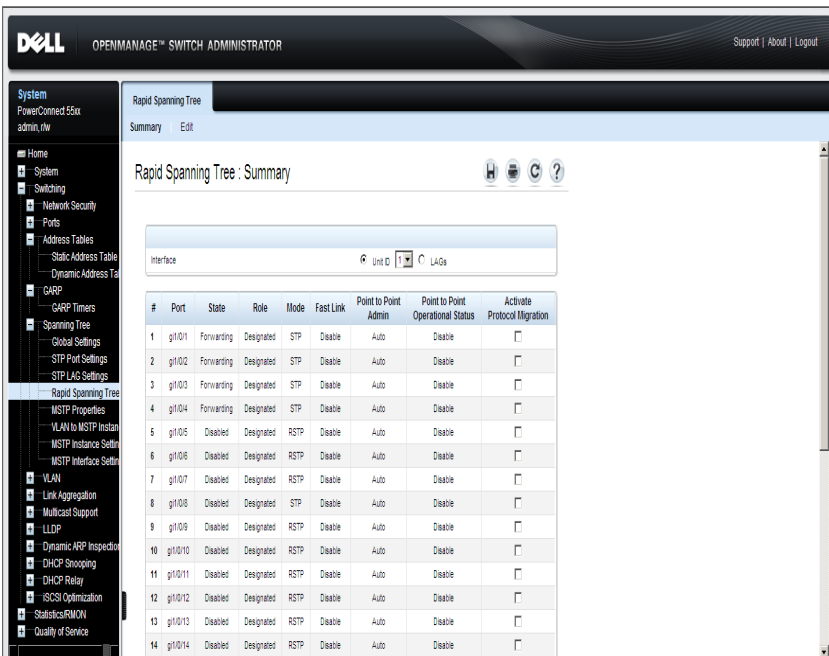

- 2 To modify RSTP settings on an interface, click **Edit** and enter the fields:
 - **Interface** — Select a port or LAG.
 - **State** — Displays the RSTP state of the selected interface.

- **Role** — Displays the port role assigned by the STP algorithm in order to provide STP paths. The possible options are:
 - **Root** — This port provides the lowest cost path to forward packets to root switch.
 - **Designated** — This port is the interface through which the bridge is connected to the LAN, which provides the lowest cost path from the LAN to the Root Bridge.
 - **Alternate** — This port provides an alternate LAG to the root switch from the root interface.
 - **Backup** — This port provides a backup path to the designated port. Backup ports occur only when two ports are connected in a loop by a point-to-point link. Backup ports also occur when a LAN has two or more connections connected to a shared segment.
 - **Disabled** — This port is not participating in the Spanning Tree.
- **Mode** — Displays if RSTP is enabled.
- **Fast Link Operational Status** — Displays if Fast Link is enabled or disabled for the port or LAG. If Fast Link is enabled for an interface, the interface is automatically placed in the forwarding state. The possible options are:
 - **Enable** — Fast Link is enabled.
 - **Disable** — Fast Link is disabled.
 - **Auto** — Fast Link mode is enabled a few seconds after the interface becomes active.
- **Point-to-Point Admin Status** — Select if a point-to-point links is established, or permits the device to establish a point-to-point link. The possible options are:
 - **Enable** — Enables the device to establish a point-to-point link, or specifies for the device to automatically establish a point-to-point link. To establish communications over a point-to-point link, the originating PPP first sends Link Control Protocol (LCP) packets to configure and test the data link. After a link is established and optional facilities are negotiated as needed by the LCP, the originating PPP sends Network Control Protocols (NCP) packets to select and configure one or more network layer protocols. When each of the chosen network layer protocols has been

configured, packets from each network layer protocol can be sent over the link. The link remains configured for communications until explicit LCP or NCP packets close the link, or until some external event occurs. This is the actual switch port link type. It may differ from the administrative state.

- **Disable** — Disables point-to-point link.
 - **Auto** — The device automatically establishes a point-to-point link.
- **Point-to-Point Operational Status** — Displays the Point-to-Point operating state.
 - **Active Protocol Migration Test** — Check to run a Protocol Migration test. This discovers whether the link partner using STP still exists, and if so whether it has migrated to RSTP or MSTP. If it still exists as an STP link, the device continues to communicate with it by using STP. Otherwise, if it has been migrated to RSTP or MSTP, the device communicates with it using RSTP or MSTP, respectively.

Defining Rapid STP Parameters Using CLI Commands

The following table summarizes the CLI commands for defining Rapid STP parameters as displayed in the **Rapid Spanning Tree** pages.

Table 13-3. Rapid STP Parameters CLI Command

CLI Command	Description
<code>spanning-tree link-type {point-to-point shared}</code>	Overrides the default link-type setting determined by the port duplex mode, and enables RSTP transitions to the forwarding state.
<code>no spanning-tree spanning-tree link-type</code>	Use the no form of this command to restore the default configuration.
<code>clear spanning-tree detected-protocols interface</code> <code>[[gigabitethernet tengigabitethernet] port-number port-channel LAG-number]</code>	Restarts the protocol migration process.

Table 13-3. Rapid STP Parameters CLI Command (Continued)

CLI Command	Description
<code>show spanning-tree</code> [[<i>gigabitethernet</i> <i>tengigabitethernet</i>] <i>port-number</i> <i>port-channel</i> <i>LAG-number</i>]	Displays spanning tree configuration.

The following is an example of the CLI commands:

```
console(config)# interface gi1/0/5  
console(config-if)# spanning-tree link-type shared
```

Multiple Spanning Tree

This section describes Multiple Spanning Tree Protocol (MSTP).

It contains the following topics:

- MSTP Overview
- MSTP Properties
- VLAN to MSTP Instance
- MSTP Instance Settings
- MSTP Interface Settings

MSTP Overview

MSTP maps VLANs into STP instances, using various load balancing scenarios. As a result of this partitioning into instances, if port A is blocked in one STP instance, the same port can be placed in the **Forwarding State** in another STP instance.

In addition, packets assigned to various VLANs are transmitted along different paths within Multiple Spanning Trees Regions (MST Regions). Regions are one or more Multiple Spanning Tree bridges by which frames can be transmitted.

MSTP Properties

To set an MSTP region:

- 1 Click **Switching > Spanning Tree > MSTP Settings** in the tree view to display the **MSTP Properties: Summary** page.

Figure 13-5. MSTP Properties: Summary

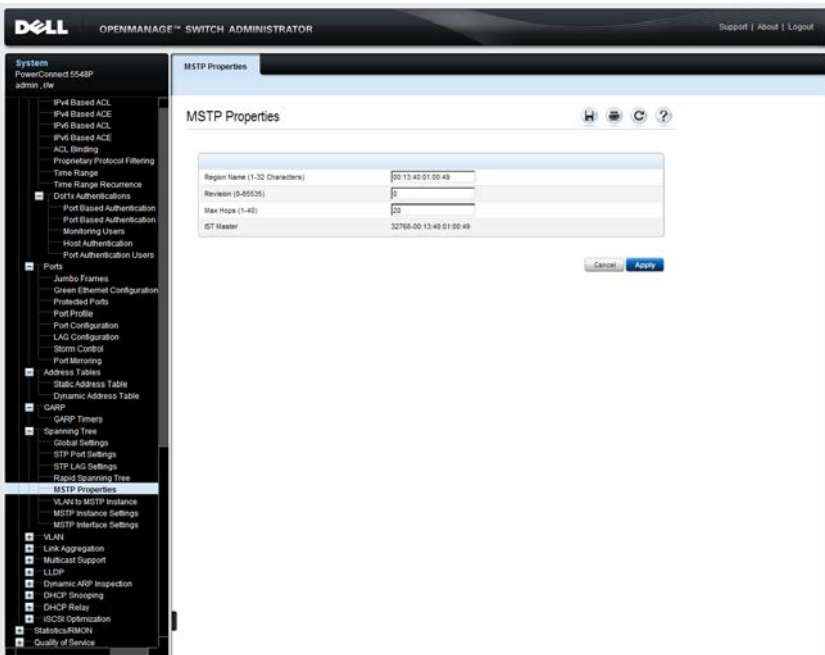

- 2 Enter the following fields:
 - **Region Name (1-32 Characters)** — Enter the user-defined MSTP region name.
 - **Revision (0-65535)** — Enter the unsigned 16-bit number that identifies the current MST configuration revision. The revision number is required as part of the MST configuration.
 - **Max Hops (1-40)** — Enter the total number of hops that occur in a specific region before the BPDU is discarded. Once the BPDU is discarded, the port information is aged out.
 - **IST Master** — Displays the Internal Spanning Tree Master ID. The IST Master is the instance 0 root.

Configuring MST Properties Using CLI Commands

The following table summarizes the CLI commands for configuring MST properties in the **MSTP Properties** pages.

Table 13-4. MSTP Properties CLI Commands

CLI Command	Description
<code>spanning-tree mst configuration</code>	Enters MST Configuration mode.
<code>spanning-tree mst max-hops hop-count</code>	Configures the number of hops in an MST region before the BDPU is discarded and the port information is aged out (in Global Configuration mode).
<code>no spanning-tree mst max-hops</code>	Use the no form of this command to restore the default configuration.
<code>name string</code>	Sets the MSTP region name.
<code>no name</code>	Use the no form of this command to restore the default setting.
<code>revision value</code>	Defines the MST configuration revision number.
<code>no revision</code>	Use the no form of this command to restore the default configuration.
<code>exit</code>	Exits the MST region configuration mode after applying configuration changes.

Table 13-4. MSTP Properties CLI Commands (Continued)

CLI Command	Description
<code>show {current pending}</code>	Displays the current or pending MST region configuration.
<code>show spanning tree mst-configuration</code>	Displays the MSTP configuration.

The following is an example of the CLI commands:

```
console(config)# spanning-tree mst configuration
console(config-mst)# instance 1 add vlan 10-20
console(config-mst)# name region1
console(config-mst)# revision 1
console(config)# interface gil/0/1
console(config-if)# spanning-tree mst 1 port-priority 144
console(config)# spanning-tree mst max-hops 10
console(config)# spanning-tree mst configuration
console(config-mst)# instance 2 add vlan 21-30
console(config-mst)# name region1
console(config-mst)# revision 1
console(config-mst)# show pending
Pending MST configuration
Name: Region1
Revision: 1
Instance VLANs Mapped
-----
0          1-9,31-4094
1          10-20
2          21-30
```

VLAN to MSTP Instance

To map VLANs to MSTP instances:

- 1 Click **Switching > Spanning Tree > VLAN to MSTP Instance** in the tree view to display the **VLAN to MSTP Instance: Summary** page.

Figure 13-6. VLAN to MSTP Instance: Summary

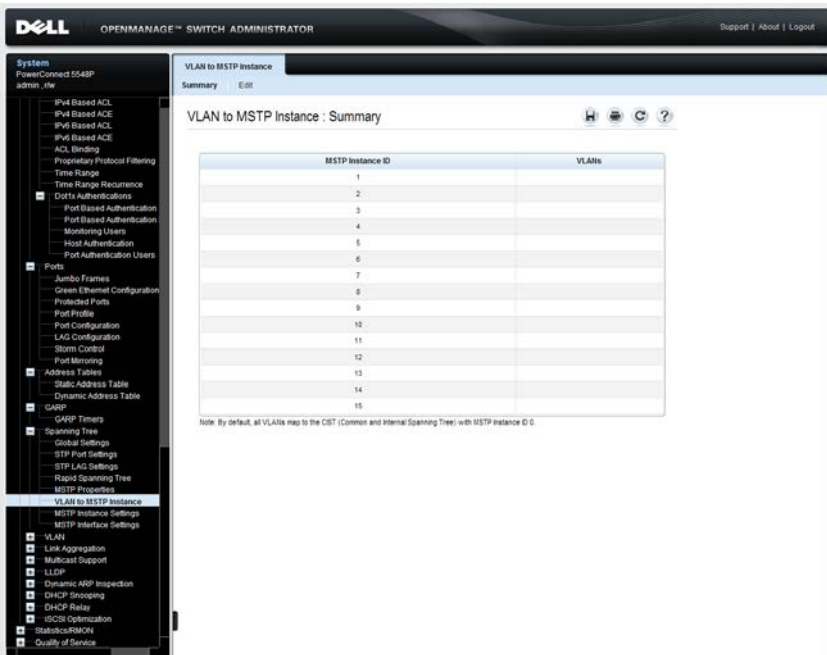

The MSTP instances and their associated VLANs are displayed.

- 2 To associate a VLAN with an MSTP instance, click **Edit**.
- 3 Select the MSTP instance, the VLAN and whether to add or remove the VLAN from the MSTP instance association.
- 4 Enter the fields:
 - **Select MST Instance ID** — Select an MST instance.
 - **VLANs** — Enter the VLANs being mapped to this instance.
 - **Action** — Select the mapping action. The possible options are:

- **Add** —Add these VLANs to the MST instance.
- **Remove** —Remove these VLANs from the MST instance.

Mapping VLAN to MSTP Instances Using CLI Commands

The following table summarizes the CLI commands for mapping VLANs to MSTP instances.

Table 13-5. Mapping VLAN to MSTP Instances Using CLI Commands

CLI Command	Description
spanning-tree mst configuration	Enters MST Configuration mode.
instance <i>instance-id</i> vlan <i>vlan-range</i>	Maps VLANs to an MST instance. Use the no form of this command to restore default mapping.
no instance <i>instance-id</i> vlan <i>vlan-range</i>	
show spanning-tree detail	Displays the spanning-tree configuration

The following is an example of the CLI commands:

```
console(config)# spanning-tree mst configuration
console(config-mst)# instance 1 vlan 10-20
```

MSTP Instance Settings

To configure MSTP instances:

- 1 Click **Switching > Spanning Tree > MSTP Instance Settings** in the tree view to display the **MSTP Instance Settings** page.

Figure 13-7. MSTP Instance Settings

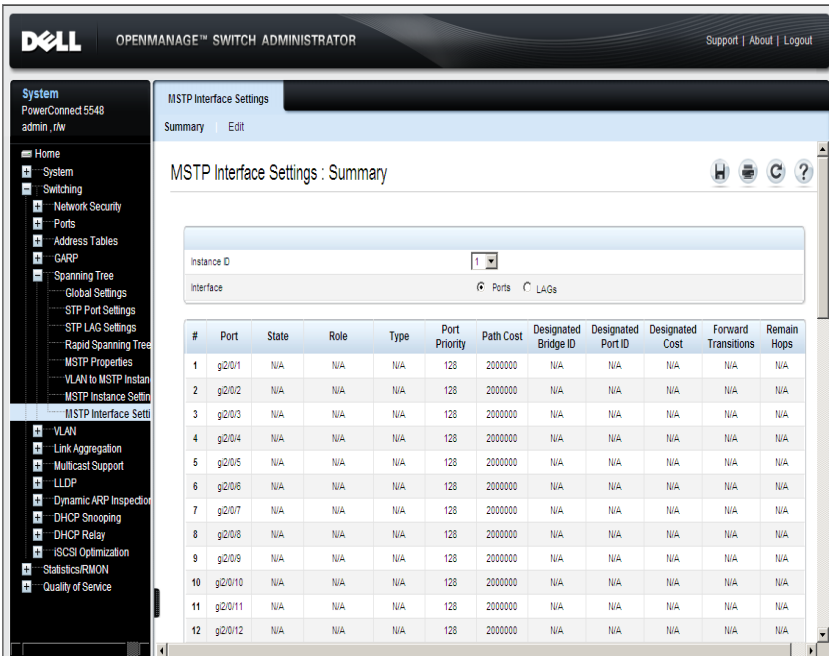

The MSTP instances and their associated VLANs are displayed.

- 2 Select an **Instance ID**.
- 3 Enter the **Bridge Priority (0-61440)** of this bridge for the selected MSTP instance.
- 4 The following fields are displayed:
 - **Included VLANs** — Displays VLANs included in this instance.
 - **Designated Root Bridge ID** — Priority and MAC address of the Root Bridge for the MST instance.

- **Root Port** — Root port of the selected instance.
- **Root Path Cost** — Root path cost of the selected instance.
- **Bridge ID** — Bridge priority and the MAC address of this switch for the selected instance.
- **Remaining Hops** — Number of hops remaining to the next destination.

Configuring MSTP Instances Using CLI Commands

The following table summarizes the CLI commands for configuring the fields in the MSTP Instance pages.

Table 13-6. Configuring MSTP Instances CLI Commands

CLI Command	Description
spanning-tree mst configuration	Enters MST Configuration mode.
spanning-tree mst <i>instance-id</i> <i>priority</i>	Configures the device priority for the specified spanning-tree instance.
no spanning-tree mst <i>instance-id</i> <i>priority</i>	Use the no form of this command to restore the default configuration.
show spanning-tree detail	Displays the spanning-tree configuration

The following is an example of the CLI commands:

```
console(config)# spanning-tree mst configuration
console(config-mst)# spanning-tree mst 1 priority 4096
```

MSTP Interface Settings

To assign interfaces to MSTP instances:

- 1 Click **Switching > Spanning Tree > MSTP Interface Settings** in the tree view to display the **MSTP Interface Settings: Summary** page.

Figure 13-8. MSTP Interface Settings: Summary

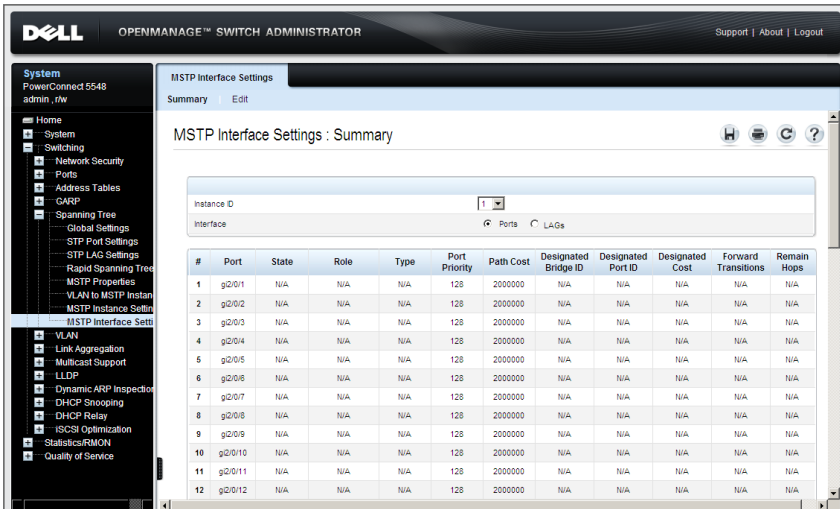

MSTP interface settings for the selected instance is displayed.

- 2 To set MSTP settings for an interface, click **Edit**.
- 3 Select an instance, and enter the fields:
 - **Interface ID** — Assign either ports or LAGs to the selected MSTP instance.
 - **Port State** — Displays whether the port is enabled or disabled in the specific instance.
 - **Type** — Displays whether MSTP treats the port as a point-to-point port, or a port connected to a hub, and whether the port is internal to the MST region or a boundary port. A Master port provides connectivity from a MSTP region to the outlying CIST root. A

Boundary port attaches MST bridges to LAN in an outlying region. If the port is a boundary port, it also indicates whether the device on the other side of the link is working in RSTP or STP mode.

- **Role** — Displays the port role assigned by the STP algorithm in order to provide to STP paths. The possible options are:
 - **Root** — This port provides the lowest cost path to forward packets to root switch.
 - **Designated** — This port is the interface through which the bridge is connected to the LAN, which provides the lowest cost path from the LAN to the Root Bridge.
 - **Alternate** — This port provides an alternate LAG to the root switch from the root interface.
 - **Backup** — This port provides a backup path to the designated port. Backup ports occur only when two ports are connected in a loop by a point-to-point link. Backup ports also occur when a LAN has two or more connections connected to a shared segment.
 - **Disabled** — This port is not participating in the Spanning Tree.
- **Interface Priority** — Enter the interface priority for specified instance.
- **Path Cost (1-200,000,000)** — Enter the port contribution to the Spanning Tree instance. If a loop occurs, the spanning tree considers path cost when selecting an interface to put in the Forwarding state.
- **Default Path Cost** — Check to use the default path cost.
- **Designated Bridge ID** — Displays the bridge ID number that connects the link or shared LAN to the root.
- **Designated Port ID** — Displays the Port ID number on the designated bridge that connects the link or the shared LAN to the root.
- **Designated Cost** — Displays the cost of the path from the link or the shared LAN to the root.
- **Forward Transitions** — Displays the number of times the port changed to the forwarding state.
- **Remain Hops** — Displays the number of hops remaining to the next destination.

Defining MSTP Interfaces Using CLI Commands

The following table summarizes the CLI commands for defining MSTP interfaces as displayed in the **MSTP Interfaces** pages.

Table 13-7. MSTP Interface CLI Commands

CLI Command	Description
spanning-tree mst <i>instance-id cost cost</i>	Sets the path cost of the port for MST calculations (in Interface Configuration mode).
no spanning-tree mst <i>instance-id cost</i>	Use the no form of this command to restore the default configuration.
spanning-tree mst <i>instance-id port-</i> priority priority	Configures the device priority for the specified spanning-tree instance (in Interface Configuration mode). Use the no form of this command to restore the default configuration.
show spanning-tree mst- configuration	Displays the MST configuration.

The following is an example of the CLI commands:

```
console(config)# interface gil/0/9  
console(config-if)# spanning-tree mst 1 cost 4
```

14

VLANs

This chapter describes how VLANs are configured on the device.

It contains the following topics:

- Virtual LAN Overview
- VLAN Membership
- Port Settings
- LAGs Settings
- Protocol Groups
- Protocol Port
- GVRP Parameters
- Private VLAN
- Voice VLAN

Virtual LAN Overview

A VLAN is a switched network that is logically segmented on an organizational basis, by functions, project teams, or applications rather than on a physical or geographical basis. For example, all workstations and servers used by a particular workgroup team can be connected to the same VLAN, regardless of their physical connections to the network, or the fact that they might be intermingled with other teams. Reconfiguration of the network can be done through software rather than by physically unplugging and moving devices or wires.

A VLAN can be thought of as a Broadcast domain that exists within a defined set of switches. A VLAN consists of a number of end systems, either hosts or network equipment (such as bridges and routers), connected by a single bridging domain. The bridging domain is supported on various pieces of network equipment; for example, LAN switches that operate bridging protocols between them with a separate bridge group for each VLAN.

VLANs are created to provide the segmentation services traditionally provided by routers in LAN configurations. VLANs address scalability, security, and network management. Routers in VLAN topologies provide broadcast filtering, security, address summarization, and traffic flow management.

None of the switches, within a defined group, will bridge any frames, not even broadcast frames, between two VLANs.

Frame Flow

Figure 16-1 describes the flow of VLAN frames from the Ingress port to the Egress port:

Figure 14-1. Frame Flow Through a VLAN

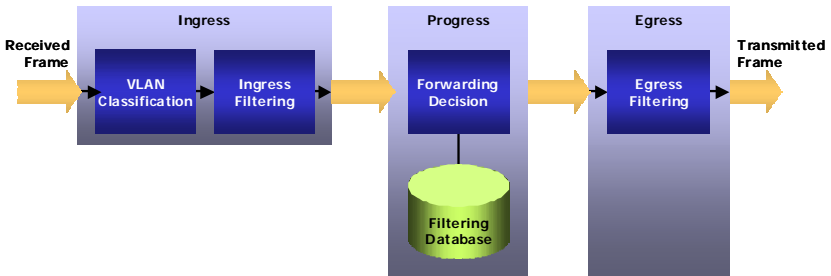

When a frame is received, it must be assigned a VLAN. VLAN assignment is accomplished by the following steps:

- 1 If the frame contains a VLAN tag, that tag is used, otherwise the frame is classified by the port's default VLAN (PVID), if it is defined.
- 2 After classification, the frame may pass (if enabled) through ingress filtering, where the frame is dropped if the frame's VLAN ID is not one of the VLANs to which the ingress port belongs.
- 3 A forwarding decision is made, as a function of the VLAN ID and the destination MAC address.
- 4 The egress rules define whether the frame is to be sent as tagged or untagged.

Special-case VLANs

VLAN#1 and VLAN#4095 are special-case VLANs:

- **VLAN1** — Defined as the default VLAN, and may only be used as a Ports Default VLAN ID (PVID). This means that if the VLAN, whose VID is the current port's PVID, is deleted from the port (or from the system), that port's PVID is set to 1. VLAN#1 cannot be deleted from the system.
- **VLAN #4095** — Defined (according to standard and industry practice) as the "discard" VLAN. A frame classified to this VLAN is silently dropped.

QinQ Tagging

QinQ tagging enables you to add an additional tag to previously-tagged packets. The added tag provides a VLAN ID to each customer, which ensures private and segregated network traffic. The VLAN ID tag is assigned to a customer port in the service provider network. The designated port then provides additional services to the packets with the double-tags. This enables administrators to expand service to VLAN users.

Port Modes

Ports participating in Layer 2 switching may be classified as:

- **Access Ports**

Ports set to Access mode belong to a single VLAN, whose VID is the currently set PVID (default = 1). These ports accept all untagged frames, and all frames tagged with the VID, currently set as the port's PVID. All traffic is sent untagged. If the VLAN, whose VID is set as the current PVID of the port, is deleted from the system, or deleted from the port, the port's PVID will be set to 1, meaning that the port will be made a member of VLAN#1, the default VLAN.

Ingress filtering is always enabled for ports in Access mode.

Setting an Access port's PVID to 4095 effectively shuts it down, as no frames will be transferred in either direction.

Access mode ports are intended to connect end-stations to the system, especially when the end-stations are incapable of generating VLAN tags.

- **Trunk Ports**

Ports set to Trunk mode may belong to multiple VLANs. The default VLAN membership of a trunk port is all VLANs (1-4094). A PVID must be set on the port (it can be a non-existing VLAN). Trunk ports accept tagged and untagged frames. Untagged frames will be classified to the VLAN whose VLAN ID (VID) is configured as the port's PVID.

Frames, sent from the port in the VLAN, whose VID is the current PVID, are sent untagged. Frames sent in all other VLANs active on the port are sent tagged.

Ingress filtering is always enabled on Trunk-mode ports. Incoming frames will undergo ingress filtering, and if correctly tagged, (tagged with a VID of one of the VLANs to which the port currently belongs) are admitted.

The default PVID is 1 (the default VLAN). If another VID is configured as the port's PVID, and the corresponding VLAN is deleted from the port or from the system, the port's PVID reverts to 1, meaning that the port is made a member of the default VLAN.

Setting a trunk-port's PVID to 4095 limits traffic to tagged frames. Incoming untagged frames are silently discarded, and no frames are sent untagged.

Trunk-mode ports are intended for switch-to-switch links, where traffic is usually tagged.

- **General Ports**

Ports set to General mode may be members of multiple VLANs. Each of these VLANs may be configured to be tagged or untagged. This setting applies to transmitted frames. Incoming untagged frames are classified into the VLAN whose VID is the currently configured PVID.

Ingress filtering may be disabled on General ports. Ingress filtering is enabled by default.

- **Promiscuous Ports**

A promiscuous port can communicate with all ports of the same Private VLAN (PVLAN), including the isolated ports of the same PVLAN.

- **Isolated**

An isolated port has complete Layer 2 isolation from the other ports within the same PVLAN, but not from the promiscuous ports. Isolated ports can communicate with promiscuous ports.

In the factory default configuration, all ports are designated as Access ports, and are associated with the default VLAN.

Acceptable Frame Type

The acceptable frame type can be set on a port to accept all frames (tagged and untagged), tagged only, or untagged only. This setting takes precedence over all other settings, so that if the acceptable frame type is tagged only, incoming untagged frames are silently discarded, even if the port has a valid PVID.

VLAN Membership

The device supports up to 2-4094 VLANs.

Ports are assigned to a VLAN in the **Port Settings** pages.

To view the ports in a VLAN, and assign various parameters:

- 1 Click **Switching > VLAN > VLAN Membership** in the tree view to display the **VLAN Membership: Summary** page.

Figure 14-2. VLAN Membership: Summary

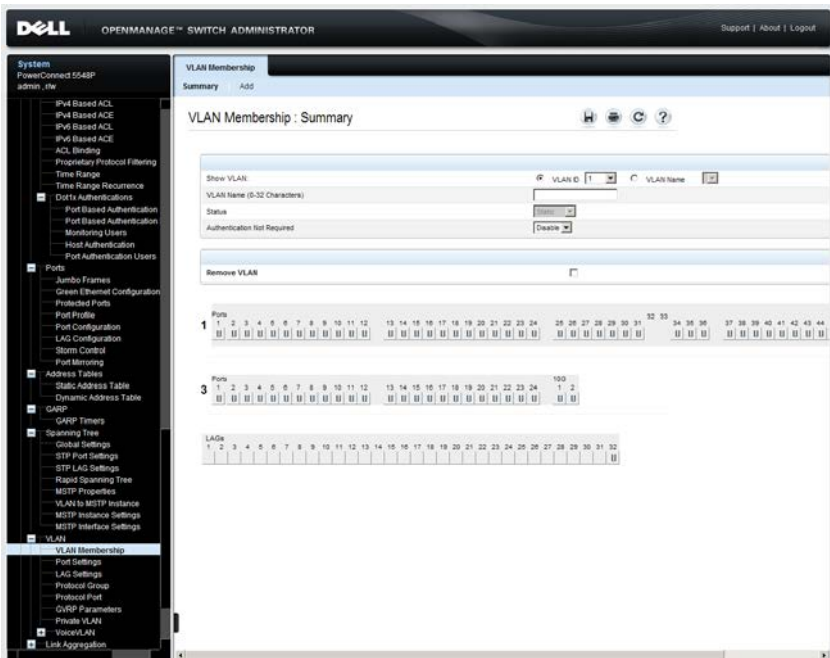

The ports in the selected unit/VLAN are displayed along with their statuses.

Each port/LAG is labeled with one of the following codes, regarding its membership in the VLAN:

- **T** — Tagged. The interface is a member of a VLAN. All packets forwarded by the interface are tagged. The packets contain VLAN information.
- **U** — Untagged. The interface is a member of a VLAN. Packets forwarded by the interface are untagged.
- **F** — Forbidden. The interface is denied membership to a VLAN.
- **Blank** — The interface is not a VLAN member. Packets associated with the interface are not forwarded.

2 Enter the fields:

- **Show VLAN** — Check one of the possible options:
 - **VLAN ID** — Check VLAN ID, and select a VLAN ID to view.
 - **VLAN Name** — Check VLAN Name, and select a VLAN ID to view.
- **VLAN Name (0-32 Characters)** — Enter a new VLAN name.
- **Status** — The VLAN type. Possible values are:
 - **Dynamic** — The VLAN was dynamically created through GVRP.
 - **Static** — The VLAN is user-defined.
- **Authentication Not Required** — Enable/disable authentication on the VLAN.

3 To define a new VLAN, click **ADD**, and enter the fields. The fields in this page are described above.

Defining VLAN Membership Using CLI Commands

The following table summarizes the CLI commands for defining VLAN membership as displayed in the **VLAN Membership** pages.

Table 14-1. VLAN Membership CLI Commands

CLI Command	Description
<code>vlan database</code>	Enters the VLAN configuration mode.

Table 14-1. VLAN Membership CLI Commands (Continued)

CLI Command	Description
vlan { <i>vlan-range</i> }[name <i>vlan-name</i>]	Creates a VLAN.
no vlan <i>vlan-range</i>	Use the no form of this command to restore the default configuration or delete a VLAN.
name <i>string</i>	Adds a name to a VLAN.
dot1x auth-not-req	Enables unauthorized devices access to the VLAN.
no dot1x auth-not-req	Use the no form of this command to disable access to the VLAN.

The following is an example of the CLI commands:

```
console(config)# vlan database
console(config-vlan)# vlan 1972
console(config-vlan)# end
console(config)# interface vlan 1972
console(config-if)# name Marketing
console(config-vlan)# dot1x auth-not-req
console(config-if)# end
```

Port Settings

After a VLAN has been defined, assign ports to it.

To assign a VLAN to untagged packets, arriving on the device, enter the port default VLAN ID (PVID). All untagged packets arriving to the device are tagged by the ports PVID.

All ports must have a defined PVID. If no other value is configured, the default VLAN PVID is used. VLAN ID #1 is the default VLAN, and cannot be deleted from the system.

To configure ports on a VLAN:

- 1 Click **Switching > VLAN > Port Settings** in the tree view to display the **Port Settings: Summary** page.

Figure 14-3. Port Settings: Summary

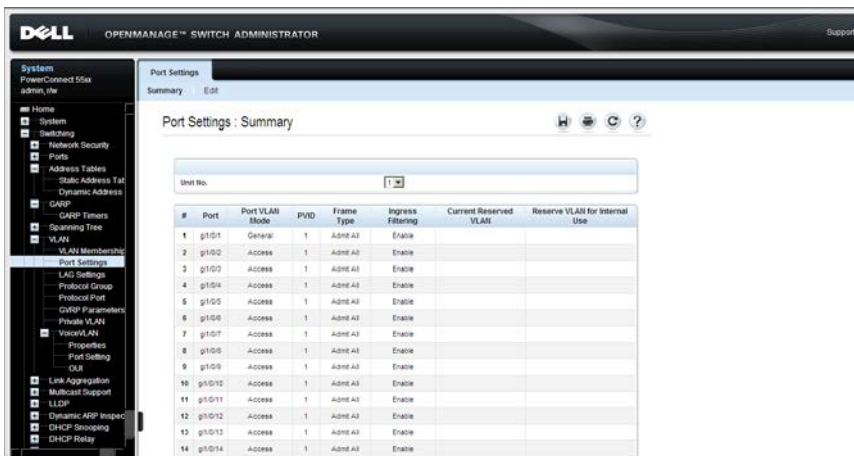

All interfaces on the selected unit and their settings are displayed.

- 2 To modify the port settings, click **Edit**, and enter the fields:
 - **Interface** — Enter the unit/port number to be modified.
 - **Switchport Mode** — Select whether the port is in Layer 2 or Layer 3. If the port is in Layer 2, enter the parameters described below, otherwise the fields are not relevant.

- **Port VLAN Mode** — Enter the port VLAN mode. The possible options are:
 - **General** — The port belongs to VLANs, and each VLAN is user-defined as tagged or untagged (full 802.1Q mode).
 - **Access** — The port belongs to a single untagged VLAN. When a port is in Access mode, the packet types that are accepted on the port cannot be designated. Ingress filtering cannot be enabled/disabled on an access port.
 - **Trunk** — The port belongs to VLANs on which all ports are tagged (except for one port that can be untagged).
 - **Customer** — When a port is in Customer mode, an added tag provides a VLAN ID to each customer, ensuring private and segregated network traffic for that customer.
 - **Private VLAN Promiscuous** — The port is a promiscuous port.
 - **Private VLAN Host** — The port is an isolated port
 - **Current Reserved VLAN** — Displays the VLAN currently designated by the system as the reserved VLAN.
 - **Reserve VLAN for Internal Use (1-4094)** — Check to enter a reserved VLAN, and enter its ID. If none is required, check **None**.
 - **PVID (1-4095)** — Enter a VLAN ID to be added to untagged packets. The possible values are 1-4095. VLAN 4095 is defined according to standard and industry practice as the discard VLAN. Packets classified to the discard VLAN are dropped.
 - **VLAN List (I - Inactive Configuration)** — Enter the VLAN(s) to which this port belongs, and indicate its type. The possible options are:
 - **T** — Tagged. The port is a member of a VLAN. All packets forwarded by the LAG are tagged. The packets contain VLAN information.
 - **U** — Untagged. The port is a member of a VLAN. Packets forwarded by the LAG are untagged.
 - **F** — Forbidden. The port is denied membership to a VLAN.
- Click **Add** to move the port to the VLAN list together with its type.

- **Frame Type** — Select the packet type accepted on the port. The possible options are:
 - **Admit All** — Both tagged and untagged packets are accepted on the port.
 - **Admit Tagged Only** — Only tagged packets are accepted on the port.
 - **Admit Untagged Only** — Only untagged packets are accepted on the port.
- **Ingress Filtering** — Enable/disable ingress filtering, which discards packets that are destined to VLANs of which the specific port is not a member.
- **Native VLAN ID(1-4094)** — Enter VLAN used for untagged traffic to trunk ports.
- **Multicast VLAN ID(1-4094)** — Enter VLAN used for Multicast TV VLAN traffic on access ports.
- **Customer VLAN ID(1-4094)** — Enter VLAN used for customer ports.

Assigning Ports to VLAN Groups Using CLI Commands

The following table summarizes the CLI commands for assigning ports to VLAN groups.

Table 14-2. Port-to-VLAN Group Assignments CLI Commands

CLI Command	Description
<code>switchport general acceptable-frame-type { tagged-only untagged-only all }</code>	Configures ingress filtering based on packet type tagged/untagged. Use the no form of this command to return to default.
<code>no switchport general acceptable-frame-type</code>	
<code>switchport mode { access trunk general }</code>	Configures the VLAN membership mode of a port.

Table 14-2. Port-to-VLAN Group Assignments CLI Commands (Continued)

CLI Command	Description
<code>switchport access vlan {vlan-id none}</code>	Configures the VLAN ID when the interface is in access mode.
<code>no switchport access vlan</code>	Use the no form of this command to restore the default configuration.
<code>switchport trunk allowed vlan {all none add vlan-list remove vlan-list except vlan-list}</code>	Sets the trunk characteristics when the interface is in Trunking mode.
<code>no switchport trunk allowed vlan</code>	Use the no form of this command to reset a trunking characteristic to the default.
<code>switchport trunk native vlan {vlan-id none}</code>	Defines the native VLAN when the interface is in trunk mode.
<code>no switchport trunk native vlan</code>	Use the no form of this command to restore the default configuration.
<code>switchport general allowed vlan {add remove} vlan-list [tagged/untagged]</code>	Sets the general characteristics when the interface is in general mode.
<code>no switchport general allowed vlan</code>	Use the no form of this command to reset a general characteristic to the default.
<code>switchport general pvid vlan-id</code>	Configures the PVID when the interface is in general mode.
<code>no switchport general pvid</code>	Use the no form of this command to restore the default configuration.
<code>switchport customer vlan vlan-id</code>	Sets the port's VLAN when the interface is in customer mode.
<code>no switchport customer vlan</code>	Use the no form of this command to restore the default configuration.

Table 14-2. Port-to-VLAN Group Assignments CLI Commands (Continued)

CLI Command	Description
switchport mode { <i>access</i> <i>trunk</i> <i>general</i> <i>private-vlan</i> { <i>promiscuous</i> <i>host</i> } <i>customer</i> }	Configure the VLAN membership mode of a port.
no switchport mode	Use the no form of this command to restore the default configuration.

The following is an example of the CLI commands:

```
console(config)# vlan database
console(config-vlan)# vlan 23-25
console(config-vlan)# end
console(config)# interface vlan 23
console(config-if)# name Marketing
console(config-if)# end
console(config)# interface gil/0/8
console(config-if)# switchport mode access
console(config-if)# switchport access vlan 23
console(config-if)# end
console(config)# interface gil/0/9
console(config-if)# switchport mode trunk
console(config-if)# switchport mode trunk allowed vlan add
23-25
console(config-if)# end
console(config)# interface gil/0/11
console(config-if)# switchport mode general
console(config-if)# switchport general allowed vlan add
23,25 tagged
console(config-if)# switchport general pvid 25
```

LAGs Settings

VLANs can either be composed of individual ports or of LAGs. Untagged packets entering the device are tagged with the LAGs ID specified by the PVID.

To configure LAGS on a VLAN:

- 1 Click **Switching > VLAN > LAG Settings** in the tree view to display the **VLAN LAG Settings** page.

Figure 14-4. VLAN LAG Settings

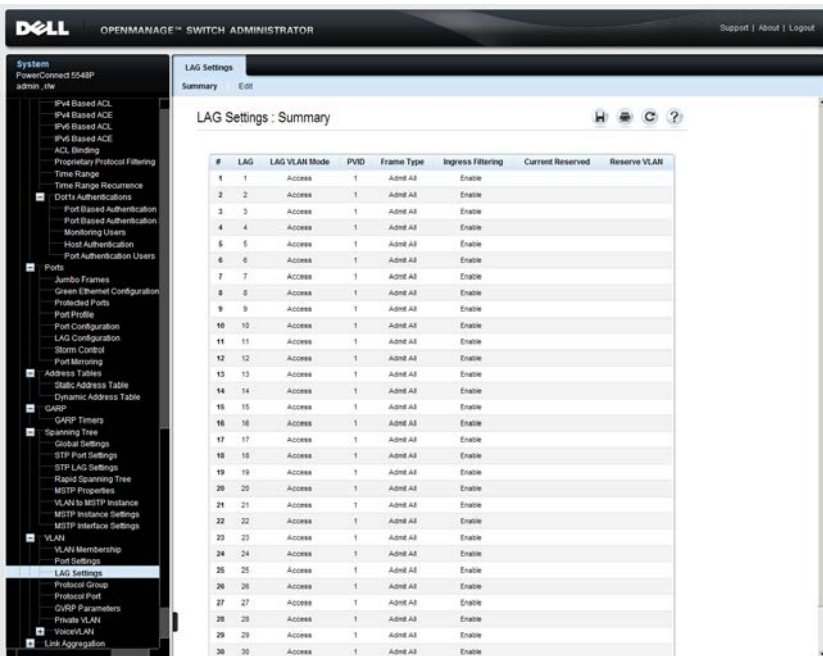

All LAGs and their settings are displayed.

- 2 To modify the LAG settings, click **Edit**, and enter the fields:
 - **LAG** — Select the LAG to be modified.
 - **Switchport Mode** — Select whether the LAG is in Layer 2 or Layer 3. If the LAG is in Layer 2, enter the parameters described below, otherwise the fields are not relevant.

- **Port VLAN Mode** — Enter the port VLAN mode. The possible options are:
 - **General** — The port belongs to VLANs, and each VLAN is user-defined as tagged or untagged (full 802.1Q mode).
 - **Access** — The port belongs to a single untagged VLAN. When a port is in Access mode, the packet types that are accepted on the port cannot be designated. Ingress filtering cannot be enabled/disabled on an access port.
 - **Trunk** — The port belongs to VLANs on which all ports are tagged (except for one port that can be untagged).
 - **Customer** — When a port is in Customer mode, an added tag provides a VLAN ID to each customer, ensuring private and segregated network traffic for that customer.
 - **Private VLAN Promiscuous** — The port is a promiscuous port.
 - **Private VLAN Host** — The port is an isolated port
- **Current Reserved VLAN** — Displays the VLAN currently designated as the reserved VLAN.
- **Reserve VLAN for Internal Use (1-4094)** — Enter the VLAN that is designated as the reserved VLAN after the device is reset, or select **None**.
- **PVID (1-4095)** — Assigns a VLAN ID to untagged packets. The possible VLAN IDs are 1-4095. VLAN 4095 is defined as per standard and industry practice, as the discard VLAN. Packets classified to this VLAN are dropped.
- **VLAN List (I - Inactive Configuration)** — Enter the VLAN(s) to which this LAG belongs, and indicate its type. The possible options are:
 - **T** — Tagged. The LAG is a member of a VLAN. All packets forwarded by the LAG are tagged. The packets contain VLAN information.
 - **U** — Untagged. The LAG is a member of a VLAN. Packets forwarded by the LAG are untagged.
 - **F** — Forbidden. The LAG is denied membership to a VLAN.

Click **Add** to move the LAG to the VLAN list together with its type.

- **Frame Type** — Packet type accepted by the LAG. The possible options are:
 - **Admit All** — Tagged and untagged packets are both accepted by the LAG.
 - **Admit Tag Only** — Only tagged packets are accepted by the LAG.
 - **Admit Untagged Only** — Only untagged packets are accepted on the LAG.
- **Ingress Filtering** — Enable/disable Ingress filtering by the LAG. Ingress filtering discards packets that are destined to VLANs of which the specific LAG is not a member.
- **Native VLAN ID (1-4094)** — Enter VLAN used for untagged traffic to trunk ports, or select **None**.
- **Multicast VLAN ID (1-4094)** — Enter VLAN used for Multicast TV VLAN traffic on access ports, or select **None**.
- **Customer VLAN ID (1-4094)** — Enter VLAN used for customer ports, or select **None**.

Assigning LAGs to VLAN Groups Using CLI Commands

Refer to Table 16-2 for a list of the LAG to VLAN CLI commands.

Protocol Groups

Protocol groups are based on protocol-based VLANs.

Protocol-based VLANs

Untagged frames received on a VLAN-aware switch can be classified by methods others than source port, such as data-link-layer protocol identification. This classification method is referred to as protocol-based VLANs.

Protocol-based VLANs are useful for isolating Layer 2 traffic of various Layer 3 protocols. If, for example, a switch serves IP stations and IPX stations that communicate with a single VLAN-unaware server, without using protocol-based VLANs, all the Layer 2 Broadcast traffic would reach all the stations. With protocol-based VLANs, the switch can forward incoming traffic from the server to stations in a specific VLAN only.

Protocol-based VLANs are only available on General ports.

Classification rules are set on a per-port basis, and may be sensitive to the frame's encapsulation. The default encapsulation assumed is Ethernet.

On each port, a user can define associations between groups of data-link layer protocols and ports. For each group/port combination, the user may set the VLAN to which frames incoming on that port will be classified if they belong to any of the protocols in the group.

Several protocol-groups may be associated to a single port, and a protocol group may be assigned to multiple ports, if so desired.

It is not guaranteed that the VLAN to which the frame is classified exists in the system, or is active on that port.

Restrictions

The following frames (packet) types are supported: Ethernet, RFC 1042, and LLC Other.

There may be dependencies between protocols and encapsulations, and specifying one protocol may automatically add additional protocols to the protocol-group, such as specifying IP implies ARP and vice-versa.

Similarly, there may be implied dependencies between encapsulations, so that specifying an encapsulation implies defining the protocol group for related encapsulations. An example of this is specifying the Ethernet encapsulation, even by default, implies IEEE802 encapsulation, as per RFC 1042.

The following standards are relevant:

- IEEE802.1V defines VLAN assignment by protocol type.
- IETF RFC 10-2 defines a standard for the transmission of IP datagrams over IEEE 802 Networks

Defining Protocol Groups

Define protocol groups in two steps:

- 1 Define a protocol group by assigning one or more protocols to the group and giving it a protocol-group ID (any integer), using the **Protocol Group** pages.
- 2 Associate the group with a desired VLAN classification, per port, using the **Protocol Port** pages.

To define a protocol group:

- 1 Click **Switching > VLAN > Protocol Group** in the tree view to display the **Protocol Group: Summary** page.

Figure 14-5. Protocol Group: Summary

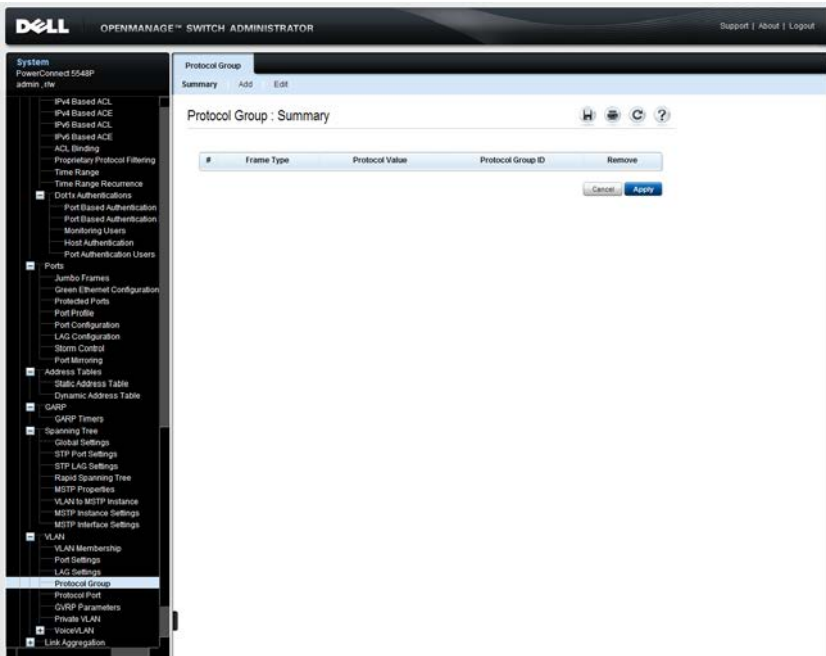

The currently-defined protocol groups are displayed.

- 2 To add a new protocol group, click **Add**, and enter the fields:
 - **Frame Type** — Select a frame type to be accepted in the protocol group.
 - **Protocol Value** — Select a protocol name.or
 - **Ethernet-Based Protocol Value (0600 - FFFF)** — Enter the Ethernet protocol group type.
 - **Protocol Group ID** — Assign a protocol group ID number.

Defining VLAN Protocol Groups Using CLI Commands

The following table summarizes the CLI commands for defining VLAN Protocol groups.

Table 14-3. VLAN Protocol Groups CLI Commands

CLI Command	Description
<code>map protocol protocol</code> <code>[encapsulation] protocols-</code> <code>group group</code>	Maps a protocol to a protocol group. Protocol groups are used for protocol-based VLAN assignment.
<code>no map protocol protocol</code> <code>[encapsulation]</code>	Use the no form of this command to delete a protocol from a group.

The following is a sample of the CLI commands:

```
console (config)# vlan database
console (config-vlan)# map protocol ip protocols-group 213
```

Protocol Port

A protocol port is a port assigned to a particular protocol group. Traffic from particular types of frames may be assigned to a protocol group, which has a port and VLAN associated with it.

To add an interface to a protocol group:

- 1 Click **Switching > VLAN > Protocol Port** in the tree view to display the **Protocol Port: Summary** page.

Figure 14-6. Protocol Port: Summary

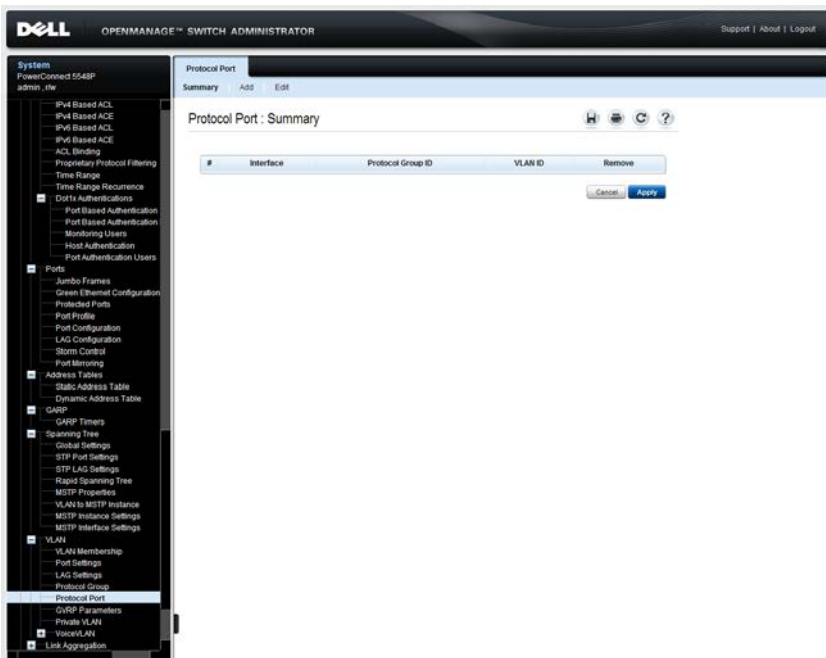

A list of previously-defined protocol groups is displayed.

- 2 To assign an interface to a protocol group, click **Add**, and enter the fields:
 - **Interface** — Port or LAG number to be added to a protocol group.
 - **Group ID** — Select a protocol group ID to which the interface is added.

- Protocol ports can either be attached to a VLAN ID or a VLAN name.
- **VLAN ID (1- 4094)** —Check and enter a VLAN ID.
 - or
 - **VLAN Name** — Check and enter a VLAN name.

Defining Protocol Ports Using CLI Commands

The following table summarizes the CLI command for defining protocol ports.

Table 14-4. **Protocol Port CLI Commands**

CLI Command	Description
switchport general map protocols-group group vlan vlan-id	Sets a protocol-based classification rule.
no switchport general map protocols-group group	Use the no form of this command to delete a classification.

The following is a sample of the CLI commands:

```
console (config-if)# switchport general map protocols-group 1 vlan 8
```

GVRP Parameters

GARP VLAN Registration Protocol (GVRP) is provided for automatic distribution of VLAN membership information among VLAN-aware bridges. GVRP enables VLAN-aware bridges to automatically learn VLANs-to-bridge-ports mapping, without having to individually configure each bridge and register VLAN membership.

To ensure the correct operation of the GVRP protocol, it is advised to set the maximum number of GVRP VLANs equal to a value which significantly exceeds:

- The number of all static VLANs both currently configured and expected to be configured.
- The number of all dynamic VLANs participating in GVRP, both currently configured (initial number of dynamic GVRP VLANs is 128) and expected to be configured.

To set GVRP parameters:

- 1 Click Switching > VLAN > GVRP Parameters in the tree view to display the GVRP Parameters: Summary page.

Figure 14-7. GVRP Global Parameters

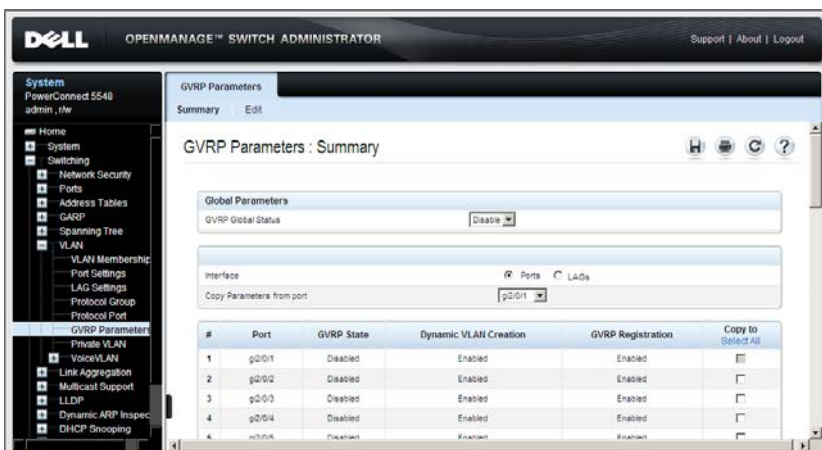

- 2 Enable/disable GVRP on the device in the GVRP Global Status field.

- 3 Check **Unit ID** and select a unit ID to view ports on the unit, or select **LAGs** to view the LAGs in the system.
- 4 To set GVRP for an interface, click **Edit**, and enter the fields:
 - **Interface** — Specifies port or LAG for editing GVRP settings.
 - **GVRP State** — Enable/disable GVRP on the interface.
 - **Dynamic VLAN Creation** — Enable/disable Dynamic VLAN creation on the interface.
 - **GVRP Registration** — Enable/disable VLAN registration through GVRP on the interface.

Configuring GVRP Using CLI Commands

The following table summarizes the CLI commands for configuring GVRP as displayed in the **GVRP Global Parameters** page.

Table 14-5. GVRP Global Parameters CLI Commands

CLI Command	Description
<code>gvrp enable</code> <code>no gvrp enable</code>	In Global Configuration mode, this command enables GVRP globally. In Interface Configuration mode, it enables GVRP on the interface. Use the no form of this command to disable GVRP on the device.
<code>gvrp vlan-creation-forbid</code> <code>no gvrp vlan-creation-forbid</code>	Enables or disables dynamic VLAN creation. Use the no form of this command to enable dynamic VLAN creation or modification.
<code>gvrp registration-forbid</code> <code>no gvrp registration-forbid</code>	De-registers all dynamic VLANs, and prevents dynamic VLAN registration on the port. Use the no form of this command to allow dynamic registration of VLANs on a port.

Table 14-5. GVRP Global Parameters CLI Commands (Continued)

CLI Command	Description
show gvrp configuration [[<i>gigabitethernet</i> <i>tengigabitethernet</i>] <i>port-number</i> <i>port-channel LAG-number</i>]	Displays GVRP configuration information, including timer values, whether GVRP and dynamic VLAN creation is enabled, and which ports are running GVRP.
show gvrp error-statistics [[<i>gigabitethernet</i> <i>tengigabitethernet</i>] <i>port-number</i> <i>port-channel LAG-number</i>]	Displays GVRP error statistics.
show gvrp statistics [[<i>gigabitethernet</i> <i>tengigabitethernet</i>] <i>port-number</i> <i>port-channel LAG-number</i>]	Displays GVRP statistics.
clear gvrp statistics [[<i>gigabitethernet</i> <i>tengigabitethernet</i>] <i>port-number</i> <i>port-channel LAG-number</i>]	Clears all the GVRP statistics information.

```

console(config)# gvrp enable
console(config)# interface gil/0/1
console(config-if)# gvrp enable
console(config-if)# gvrp vlan-creation-forbid
console(config-if)# gvrp registration-forbid
console(config-if)# end

console# show gvrp configuration
GVRP Feature is currently Disabled on the device.
Maximum VLANs: 4094
Port(s)   GVRP-Status  Registration  Dynamic VLAN Timers(milliseconds)
           Creation    Join         Leave        Leave All
-----
gil/0/1   Disabled     Normal       Enabled      200         600         10000
gil/0/2   Disabled     Normal       Enabled      200         600         10000
gil/0/3   Disabled     Normal       Enabled      200         600         10000
gil/0/4   Disabled     Normal       Enabled      200         600         10000
gil/0/5   Disabled     Normal       Enabled      200         600         10000
gil/0/6   Disabled     Normal       Enabled      200         600         10000
gil/0/7   Disabled     Normal       Enabled      200         600         10000
gil/0/8   Disabled     Normal       Enabled      200         600         10000
gil/0/9   Disabled     Normal       Enabled      200         600         10000

```

Private VLAN

Private VLANs (PVLANs) provide Layer 2 isolation between ports that share the same Broadcast domain, or in other words, they create a point-to-multipoint Broadcast domain. The ports can be located anywhere in the Layer 2 network, as opposed to protected ports which must be in the same stack.

The switch ports can be members of a Private VLAN (PVLAN) in the following membership types:

- Promiscuous ports that can communicate with all ports of the same PVLAN, including the isolated ports of the same PVLAN.
- Isolated ports that have complete Layer 2-isolation from the other ports within the same PVLAN, but not from the promiscuous ports. Isolated ports can communicate with promiscuous ports.

The PVLAN entity is implemented by allocating the following VLANs per PVLAN:

- Primary VLAN: Carries traffic from promiscuous ports.
- Isolated VLAN: Carries traffic from isolated ports.

To configure PVLANS:

- 1 Click **Switching > VLAN > Private VLAN** in the tree view to display the **Private VLAN: Summary** page.

Figure 14-8. Private VLAN: Summary

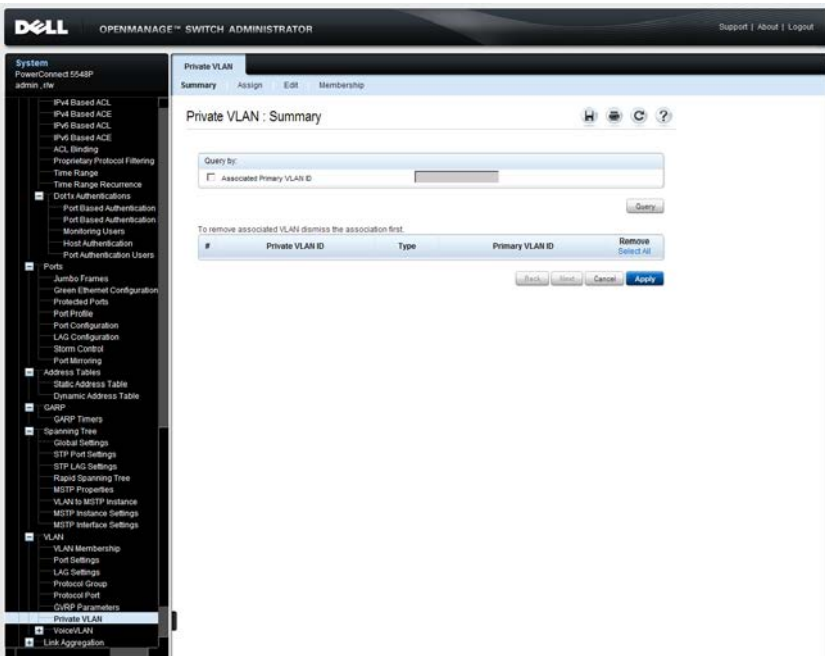

The previously-defined private VLANs are displayed.

- 2 To query by **Associated Primary VLAN ID**, check that field, enter a VLAN ID, and click **Query**. The associated VLANs are displayed.
- 3 To define a private VLAN, click **Assign**, and enter the fields:
 - **Private VLAN ID** — Select a VLAN to be assigned.
 - **Private VLAN Type** — Select one of the possible options:
 - **Primary** — Traffic from promiscuous ports flow through this type of VLAN. This is for the internet or shared servers.
 - **Isolated** — Traffic from isolated ports flow through this type of VLAN.

- **Associate Primary VLAN** — If the Private VLAN type is Isolated, check to associate the isolated VLAN with a primary VLAN, thus allowing traffic between isolated and promiscuous ports.
 - **Primary VLAN ID** — Select a VLAN to be associated with the isolated VLAN.
- 4** To assign ports to the private VLAN, click **Membership**.
 - 5** Select a Primary VLAN ID.
 - 6** Select a Isolated VLAN ID.
 - 7** Select the ports to be assigned to each VLAN, and assign each port/LAG a port type in the Admin row of ports/LAGs. The possible options are:
 - **H - Host (Isolated)** — Port is isolated.
 - **P - Promiscuous** — Port is promiscuous.
 - **C - Conditional (operational state depends on Port VLAN Mode)** — Port receives the Port VLAN type set in the **VLAN Port Settings** page. See "Port Modes" on page 462 for a description of the various port modes.

Configuring Private VLAN Using CLI Commands

The following table summarizes the CLI commands for configuring private VLANs.

Table 14-6. Private VLAN CLI Commands

CLI Command	Description
<code>private-vlan</code> <code>{primary isolated}</code>	Configures a private VLAN. Use the no form of this command to return the VLAN to normal VLAN configuration.
<code>no private-vlan</code>	
<code>private-vlan association</code> <code>[add remove] secondary-vlan-list</code>	Configures the association between the primary VLAN and the secondary VLANs.
<code>no private-vlan association</code>	Use the no form of this command to remove the association.

Table 14-6. Private VLAN CLI Commands (Continued)

CLI Command	Description
switchport private-vlan mapping <i>primary-vlan-id</i> [add remove] <i>secondary-vlan-list</i>	Configures the VLANs of the private-vlan promiscuous port. Use the no form of this command to reset to default
no switchport private-vlan mapping	
switchport private-vlan host-association <i>primary-vlan-id secondary-vlan-id</i>	Configures the VLANs of the private-vlan host port. Use the no form of this command to reset to default.
no switchport private-vlan host-association	
show vlan private-vlan [tag <i>vlan-id</i>]	Displays private VLAN information.

The following is an example of the CLI commands:

```

console# show vlan private-vlan
Primary      Secondary    Type          Ports
-----
20           201          Isolated      gil/0/1-8
20           202          Isolated      gil/0/1-2 gil/0/9-18
20           203          Isolated      gil/0/1-2 gil/0/19-21
30           301          Isolated      gil/0/22-28
30           302          Isolated      gil/0/22, gil/0/29-38
30           303          Isolated      gil/0/22, gil/0/39-41
    
```

Voice VLAN

The Voice VLAN feature enables you to enhance VoIP service by configuring ports to carry IP-voice traffic from IP phones on a specific VLAN. This VLAN is configured with a QoS profile that ensures high voice quality.

Equipment, such as VOIP phones, transmits IP traffic with a pre-configured Organizational Unique Identifier (OUI) prefix in the source MAC address. This enables the switch to dynamically identify ports connected to the VoIP equipment and automatically add these ports to the Voice VLAN.

IP phones use one of the following modes, both of which are supported by the device:

- Use only tagged packets for all communications.
- Initially use untagged packets while retrieving the initial IP address through DHCP. Then the phone uses the Voice VLAN and starts sending tagged VoIP packets.

Non-VoIP traffic is dropped from the Voice VLAN when the device is in Auto Voice VLAN secured mode.

The Voice VLAN feature also provides QoS actions to VoIP, ensuring that the quality of voice does not deteriorate if the IP traffic is received unevenly.

To summarize, when Voice VLAN is enabled and configured, and VoIP equipment is connected to one of the switch ports, the VoIP traffic triggers the switch's Voice VLAN feature to add this port to the Voice VLAN (a VLAN that usually carries only voice traffic), and to assign traffic from this port a specific QoS profile, ensuring high voice quality.

The device supports a single voice VLAN.

Properties

To set voice VLAN parameters that apply to the voice VLAN on the device:

- 1 Click **Switching > VLAN > Voice VLAN > Properties** in the tree view to display the **Properties** page.

Figure 14-9. Properties

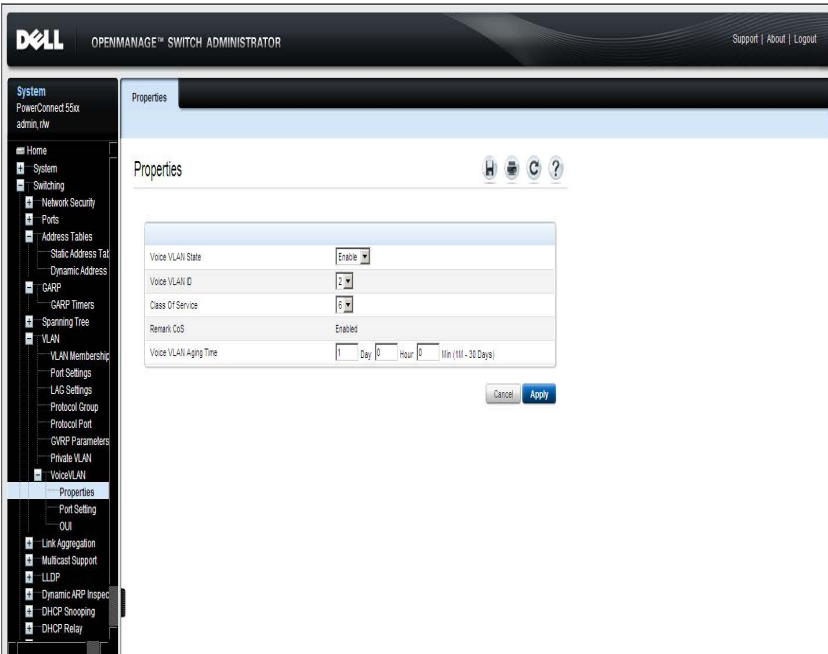

- 2 Enter the fields:
 - **Voice VLAN State** — Select **Enable** to use the Voice VLAN feature on the device.
 - **Voice VLAN ID** — Select the VLAN that is to be the voice VLAN.
 - **Class of Service** — Select to add a CoS level to untagged packets, received on the voice VLAN. The possible values are 0 to 7, where 7 is the highest priority. 0 is used as a best-effort, and is invoked automatically when no other value has been set.
 - **Remark CoS** — Displays whether the Remark CoS is enabled.

- **Voice VLAN Aging Time** — Enter the interval of time after which the port exits the voice VLAN, if no voice packets are received.

The aging time starts after the MAC address is aged out from the Dynamic MAC Address table. The default time is 300 sec. For more information on defining MAC address age out time, see "Dynamic Addresses" on page 421.

Defining Voice VLAN Properties Using CLI Commands

The following table summarizes the CLI command for defining voice VLAN properties.

Table 14-7. Voice VLAN Properties CLI Commands

CLI Command	Description
voice vlan enable	Enables automatic voice VLAN configuration for a port.
no voice vlan enable	Use the no form of this command to disable automatic voice VLAN configuration.
voice vlan id <i>vlan-id</i>	Enables the voice VLAN and configures the voice VLAN ID in Global Configuration mode.
no voice vlan id	Use the no form of this command to disable voice VLAN.
voice vlan cos <i>cos-queue</i> [remark]	Sets the voice VLAN Class of Service (CoS) queue.
no voice vlan cos	Use the no form of this command to restore the default configuration.
voice vlan aging-timeout <i>minutes</i>	Sets the voice VLAN aging timeout in Global Configuration mode.
no voice aging-timeout	Use the no form of this command to return to default.
show voice vlan [[<i>gigabitethernet</i> <i>tengigabite</i> <i>thernet</i>] <i>port-number</i> <i>port-</i> <i>channel</i> <i>LAG-number</i>]	Use the show voice vlan EXEC command to display the voice VLAN status.

The following is an example of some of the CLI commands:

```

console# show
voice vlan          1440 minutes
Aging timeout:
OUI table

MAC Address -      Description
Prefix
00:E0:BB           3COM
00:03:6B           Cisco
00:E0:75           Veritel
00:D0:1E           Pingtel
00:01:E3           Siemens
00:60:B9           NEC/Philips
00:0F:E2           Huawei-3COM
00:09:6E           Avaya
Voice VLAN VLAN
ID: 8
CoS: 6
Remark: Yes

Interface          Enabled          Secure          Activated
-----
gil/0/1            Yes             Yes            Yes
gil/0/2            Yes             Yes            Yes
gil/0/3            Yes             Yes            Yes
gil/0/4            Yes             Yes            Yes

```

Port Setting

To configure voice VLAN ports properties:

- 1 Click **Switching > VLAN > Voice VLAN > Port Setting** in the tree view to display the **Port Setting: Summary** page.

Figure 14-10. Voice VLAN Port Setting

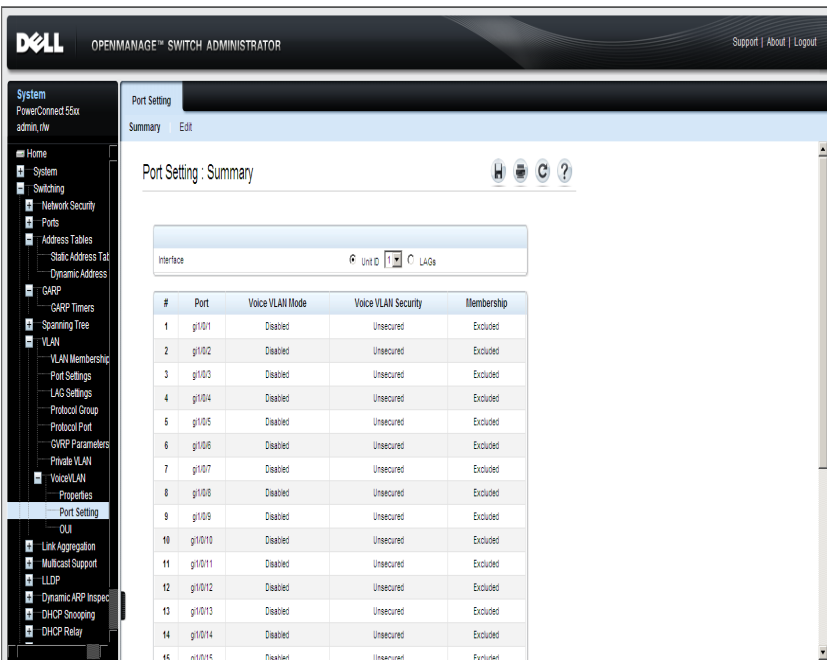

A list of the ports and their voice VLAN settings is displayed.

- 2 To modify the voice VLAN settings for an interface, click **Edit**, and enter the fields:
 - **Interface** — Enter the specific port or LAG to which the Voice VLAN settings are applied.
 - **Voice VLAN Mode** — Select the Voice VLAN mode. The possible options are:

- **None** — Disables the selected port/LAG on the Voice VLAN. This is the default.
 - **Static** — Statically adds the port to the Voice VLAN. This is usually done for VoIP uplink ports that connect the device to VoIP PBX, for example.
 - **Auto** — Indicates that if traffic with an IP phone MAC address is transmitted on the port/LAG, the port/LAG joins the Voice VLAN. The port/LAG is aged out of the voice VLAN if the IP phone's MAC address (with an OUI prefix) is aged out. If the MAC address of the IP phones OUI was added manually to a port/LAG in the voice VLAN, the user cannot add it to the Voice VLAN in Auto mode, only in Static mode.
- **Voice VLAN Security** — Enable/disable security on the interface. Security ensures that packets arriving with an unrecognized OUI are dropped (for example data packets).

Defining Voice VLAN Port Settings Using CLI Commands

The following table summarizes the CLI command for defining Voice VLAN port settings.

Table 14-8. Voice VLAN Port Settings CLI Commands

CLI Command	Description
<code>voice vlan enable</code>	Enables automatic voice VLAN configuration on a port.
<code>no voice vlan enable</code>	Use the no form of this command to disable automatic voice VLAN configuration on a port.
<code>voice vlan secure</code>	Configures secure mode for the voice VLAN.
<code>no voice vlan secure</code>	Use the no form of this command to disable secure mode.

The following is an example of the CLI commands:

```
console(config)# interface gi1/0/1
console(config-if)# voice vlan enable
console(config-if)# voice vlan secure
console(config-if)#
```

OUI

Organizationally Unique Identifiers (OUIs) are a 24-bit numbers assigned by the Institute of Electrical and Electronics Engineers, Incorporated (IEEE) Registration Authority to equipment manufacturers.

Up to 128 OUIs can be stored on the switch. Nine specific OUIs of popular VoIP phones manufacturers are stored by default.

Traffic from each type of IP phone contains the OUI for the phone manufacturer. When frames are received, in which the source MAC address's first three octets match one of the OUIs in the OUI list, the port on which they are received is automatically assigned to the Voice VLAN.

To view existing OUIs, and add new OUIs:

- 1 Click **Switching > VLAN > Voice VLAN > OUI** in the tree view to display the **OUI Summary**.

Figure 14-11. OUI: Summary

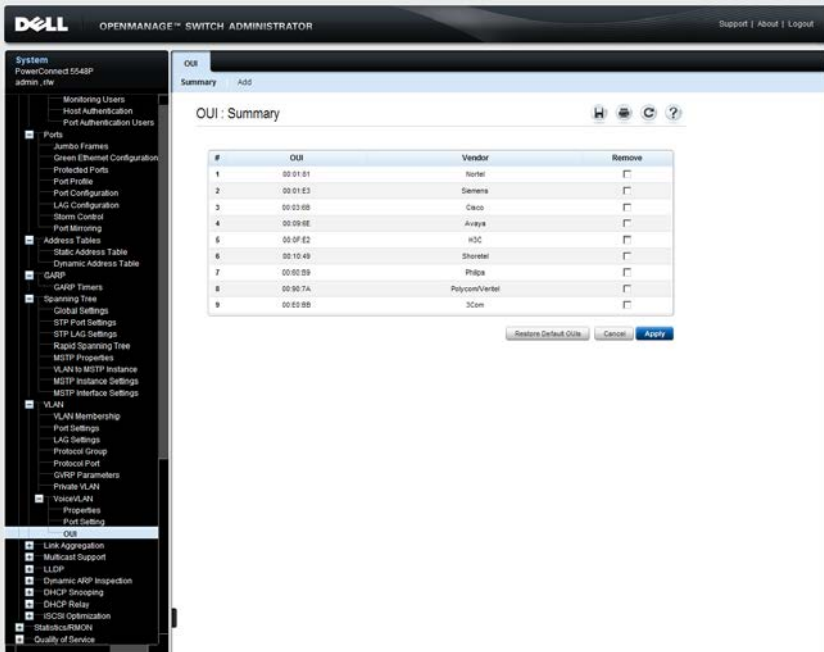

The previously-defined OUIs are displayed.

- 2 To add a new OUI, click **Add**, and enter the fields:
 - **Telephony OUI** — Enter a new OUI.
 - **Description** — Enter an OUI description up to 32 characters.

Defining Voice VLAN OUIs Using CLI Commands

The following table summarizes the CLI command for defining Voice VLAN OUIs.

Table 14-9. Voice VLAN OUIs CLI Commands

CLI Command	Description
voice vlan oui-table { <i>add</i> <i>mac-address-prefix</i> <i>remove</i> <i>mac-address-prefix</i> } [<i>text</i>]	Configures the voice OUI table.
no voice vlan oui-table	Use the no form of this command to restore the default configuration.

The following is an example of the CLI commands:

```
console(config)# voice vlan oui-table add 00:E0:BB  
console(config)#
```

Link Aggregation

This section describes link aggregation of ports.

It contains the following topics:

- Link Aggregation Overview
- LACP Parameters
- LAG Membership

Link Aggregation Overview

Link Aggregation optimizes port usage by linking a group of ports together to form a single LAG (aggregated group). Aggregating ports multiplies the bandwidth between the devices, increases port flexibility, and provides link redundancy.

The device supports the following types of LAGs:

- **Static LAGs** — Manually-configured LAGs.
- **Link Aggregation Control Protocol (LACP) LAGs** — LACP LAGs negotiate aggregating a port's links with other LACP ports located on a different device. If the other device ports are also LACP ports, the device establishes a LAG between them.

When you aggregate ports, the ports and LAG must fulfill the following conditions:

- All ports within a LAG must be the same media type.
- A VLAN is not configured on the port.
- The port is not assigned to another LAG.
- Auto-negotiation mode is not configured on the port.
- The port is in full-duplex mode.
- All ports in the LAG have the same ingress filtering and tagged modes.
- All ports in the LAG have the same back pressure and flow control modes.
- All ports in the LAG have the same priority.
- All ports in the LAG have the same transceiver type.
- The device supports up to 32 LAGs, and eight ports in each LAG.
- Ports can be configured as LACP ports only if the ports are not part of a previously configured LAG.

Ports added to a LAG lose their individual port configuration. When ports are removed from the LAG, the original port configuration is applied to the ports.

The device uses a hash function to assign packets to a LAG member. The hash function statistically load-balances the aggregated link members. The device considers an Aggregated Link to be a single logical port.

Aggregate ports can be linked into link-aggregation port-groups. Each group comprises ports with the same speed, set to full-duplex operations.

Ports in a LAG can contain different media types if the ports are operating at the same speed. Aggregated links can be manually or automatically configured by enabling LACP on the relevant links.

LACP Parameters

To define LACP LAGs, configure LACP global and port parameters, such as LACP system priority, timeout, and port priority.

With all factors equal, when the LAG is configured with more candidate ports than the maximum number of active ports allowed, the switch activates the highest priority candidate ports from the dynamic LAG.

To set LACP parameters:

- 1 Click **Switching > Link Aggregation > LACP Parameters** in the tree view to display the **LACP Parameters** page.

Figure 15-1. LACP Parameters

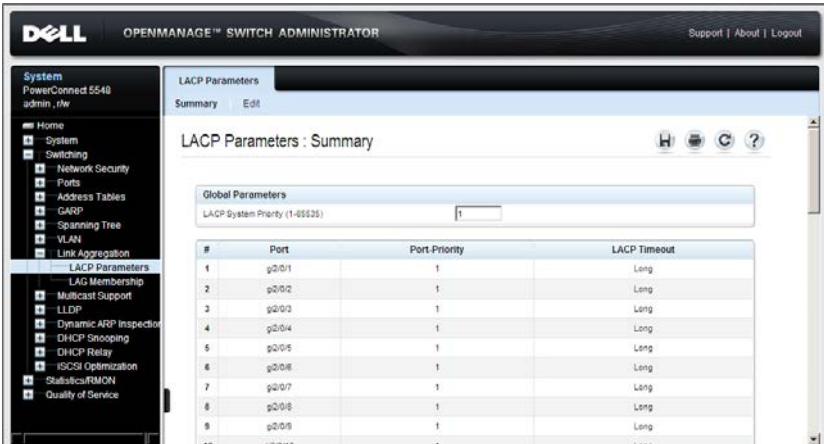

The LACP parameters for all ports are displayed.

- 2 Enter the global **LACP System Priority (1-65535)** value that determines which candidate ports will become members of the LAG.

The page displays the LACP settings of the ports on the selected unit.

- 3 To modify LACP parameters for a particular port, click **Edit**, and enter the following fields:
 - **Port** — Select the port for which timeout and priority values are assigned.

- **LACP Port Priority (1-65535)** — Enter the LACP priority value for the port.
- **LACP Timeout** — Select the rate of periodic transmissions of LACP PDUs. The possible options are:
 - **Long** — Slow transmission rate
 - **Short** — Fast transmission rate

Configuring LACP Parameters Using CLI Commands

The following table summarizes the CLI commands for configuring LACP parameters as displayed in the **LACP Parameters** page.

Table 15-1. LACP Parameters CLI Commands

CLI Command	Description
<code>lacp system-priority value</code>	Configures the system priority.
<code>lacp port-priority value</code>	Configures the priority value for physical ports.
<code>lacp timeout {long short}</code>	Assigns an administrative LACP timeout.
<code>show lacp</code> <code>[gigabitethernet tengigabitether</code> <code>net] port-number</code> <code>[parameters statistics protocol-</code> <code>state]</code>	Displays LACP information for ethernet ports.

The following is an example of the CLI commands:

```
console (config)# lACP system-priority 120
console (config)# interface gil/0/11
console (config-if)# lACP port-priority 247
console (config-if)# lACP timeout long
console (config-if)# end
console# show lACP gil/0/11 statistics
Port gil/0/11 LACP Statistics:
LACP PDUs sent:2
LACP PDUs received:2
```

LAG Membership

Each device supports up to 32 LAGs per system, and eight ports per LAG.

When you add a port to a LAG, the port acquires the LAG's properties. If the port cannot be configured with the LAG's properties, it is not added to the LAG and an error message is generated.

If the first port joining the LAG cannot be configured with the LAG settings, the port is added to the LAG, using the port default settings, and an error message is generated. Since this is the only port in the LAG, the entire LAG operates with the port's settings, instead of the LAG's defined settings.

To assign ports to LAGs:

- 1 Click **Switching > Link Aggregation > LAG Membership** in the tree view to display the **LAG Membership: Summary** page.

Figure 15-2. LAG Membership: Summary

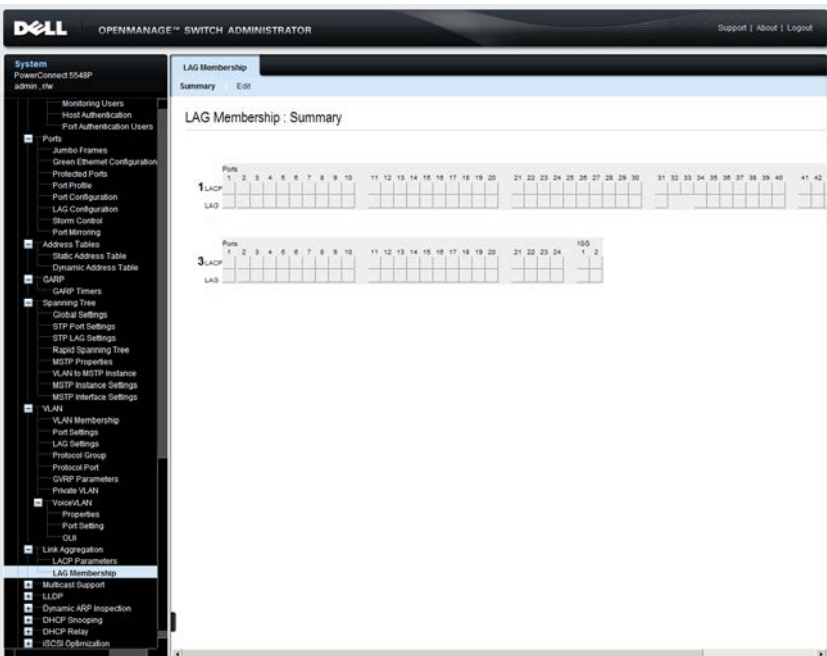

The LACP and static LAGs on each unit are displayed along with their member ports.

This page displays the following fields:

- **LACP** — Aggregates the port to a LAG, using LACP.
 - **LAG** — Adds a port to a LAG, and indicates the specific LAG to which the port belongs.
- 2** Click **Edit** to change the status of a port in a LAG.
 - 3** Select the LAG.
 - 4** In the LACP row (the first row), toggle the button under the port number to assign either the LACP or the static LAG.
 - 5** In the LAG row (the second row), toggle the button to a specific number to aggregate or remove the port to that LAG number.

Adding Ports to LAGs Using CLI Commands

The following table summarizes the CLI commands for assigning ports to LAGs as displayed in the **LAG Membership** pages.

Table 15-2. LAG Membership CLI Commands

CLI Command	Description
channel-group <i>LAG-number</i> mode { on auto }	Associates a port with a port-channel with or without a LACP operation.
no channel-group	Use the no form of this command to remove the channel-group configuration from the interface.
show interfaces port-channel [<i>LAG-number</i>]	Displays port-channel information for all port channels or for a specific port channel.

The following is an example of the CLI commands:

```
console(config)# interface gi1/0/11
console(config-if)# channel-group 1 mode on
```

16

Multicast

This chapter describes Multicast support on the device.

It contains the following topics:

- Multicast Support Overview
- Global Parameters
- Bridge Multicast Groups
- Bridge Multicast Forward All
- IGMP Snooping
- Unregistered Multicast
- Multicast TV VLAN
- Multicast TV VLAN Mapping

Multicast Support Overview

Multicast forwarding enables a single packet to be forwarded to multiple destinations. Layer 2 Multicast service is based on a Layer 2 device receiving a single packet addressed to a specific Multicast address. Multicast forwarding creates copies of the packet, and transmits the packets to the relevant ports.

There are two types of Multicast groups:

- **Registered Multicast Group** — When traffic addressed to a registered Multicast group is received, it is handled according to its entry in the Multicast Filtering Database and forwarded only to the registered ports.
- **Unregistered Multicast Group** — If traffic addressed to an unregistered Multicast group is received, it is handled by a special entry in the Multicast Filtering Database. The default setting of this is to flood all such traffic (traffic in unregistered Multicast groups).

The device supports:

- **Forwarding L2 Multicast Packets** — Forwards Layer 2 Multicast packets. Layer 2 Multicast filtering is enabled by default, and is not user-configurable.
- **Filtering L2 Multicast Packets** — Forwards Layer 2 packets to interfaces. If Multicast filtering is disabled, Multicast packets are flooded to all relevant ports.



NOTE: The system supports Multicast filtering for 256 Multicast groups.

Layer 2 Switching

Layer 2 switching forwards Multicast packets to all relevant VLAN ports by default, managing the packet as a single Multicast transmission. While Multicast traffic forwarding is effective, it is not optimal, as irrelevant ports also receive the Multicast packets. The excess packets cause increased network traffic. Multicast forwarding filters enable forwarding of Layer 2 packets to a subset of ports instead of to all ports.

IGMP

Internet Group Multicast Protocol (IGMP) adds IGMP packets to Multicast traffic. When IGMP Snooping is enabled globally, all IGMP packets are forwarded to the CPU. The CPU analyzes the incoming packets and determines:

- Which ports want to join which Multicast groups.
- Which ports have Multicast routers generating IGMP queries.
- What routing protocols are forwarding packets and Multicast traffic.

Ports requesting to join a specific Multicast group issue an IGMP report, specifying that the Multicast group is accepting members. This results in the creation of an entry in the Multicast filtering database.

Global Parameters

To enable Multicast filtering and IGMP Snooping:

- 1 Click **Switching > Multicast Support > Global Parameters** in the tree view to display the **Global Parameters** page.

Figure 16-1. Global Parameters

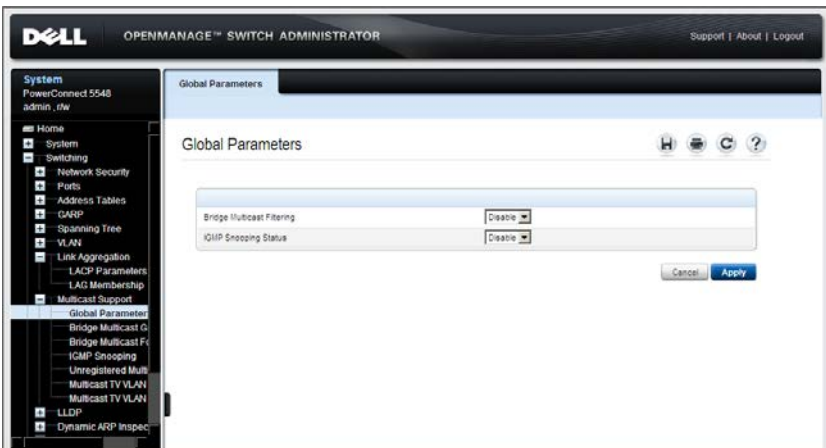

- 2 Enter the fields:
 - **Bridge Multicast Filtering** — Enable/disable Multicast filtering. Disabled is the default value.
 - **IGMP Snooping Status** — Enable/disable IGMP Snooping on the device. Disabled is the default value.

Enabling Multicast Filtering and IGMP Snooping Using CLI Commands

The following table summarizes the CLI commands for enabling Multicast Filtering and IGMP snooping as displayed on the **Global Parameters** page.

Table 16-1. Multicast Filtering and Snooping CLI Commands

CLI Command	Description
<code>bridge multicast filtering</code>	Enables filtering of Multicast addresses.
<code>no bridge multicast filtering</code>	Use the no form of this command to disable multicast address filtering.
<code>ip igmp snooping</code>	Enables Internet Group Membership Protocol (IGMP) snooping.
<code>no ip igmp snooping</code>	Use the no form of this command to disable IGMP snooping.

The following is an example of the CLI commands:

```
console(config)# bridge multicast filtering  
console(config)# ip igmp snooping
```

Bridge Multicast Groups

The **Bridge Multicast Group: Summary** page displays the ports and LAGs attached to a Multicast service group and the manner in which the port or LAG joined it.

To add and configure a Multicast group:

- 1 Click **Switching > Multicast Support > Bridge Multicast Group** in the tree view to display the **Bridge Multicast Group: Summary** page.

Figure 16-2. Bridge Multicast Group: Summary

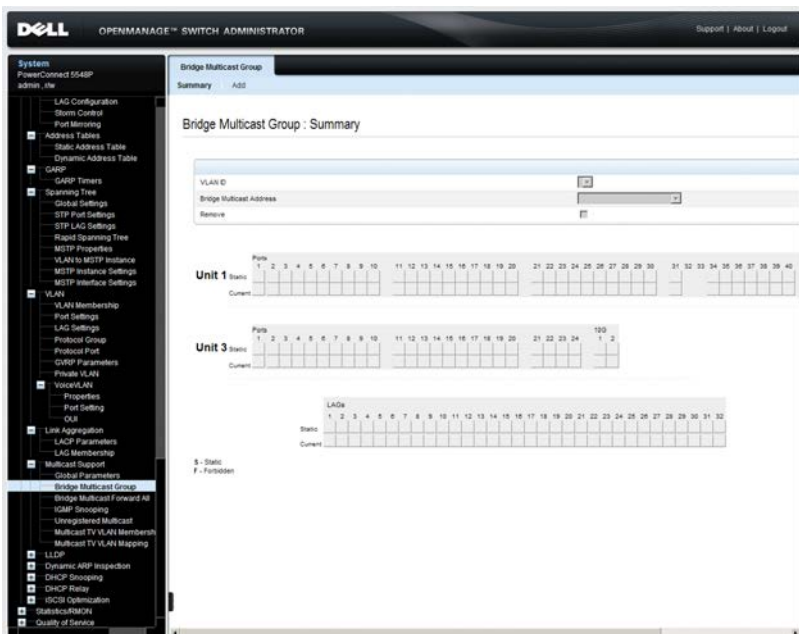

The ports and LAGs in the selected Multicast Group are displayed.

- 2 Select a VLAN and enter the Multicast group IP address in **Bridge Multicast Address**.

Two rows of ports and LAGs are displayed: for each unit

- **Static** — Displays available static ports/LAGs. These port/LAGs can be included or excluded from the Multicast groups, as described below.
 - **Current** — Displays status of ports/LAGs in the Multicast group, as actually applied.
- 3 For each port in the VLAN, toggle to **S** to join the port to the selected Multicast group as a static port. Toggle a port to **F** to indicate that it is **Forbidden** to this group. Leave the field empty if it is not involved in the VLAN.
 - 4 To add a new Multicast group, click **Add**, and enter the fields:
 - **VLAN ID** — Select the VLAN ID to set its forwarding method.
 - **New Bridge IP Multicast** — Enter a Multicast group IP address.
 - **New Bridge MAC Multicast** — Enter a Multicast group MAC address.
 - **Ports** — Select the ports to be added to a Multicast service. Toggle a port to **S** to join the port to the selected Multicast group as a static port. Toggle a port to **F** to indicate that it is **Forbidden** to this service. Leave the field empty if it is not involved in the VLAN.
 - **LAGs** — Select the LAGs to be added to a Multicast service. Toggle a LAG to **S** to join the port to the selected Multicast group as a static LAG. Toggle a port to **F** to indicate that it is **Forbidden** to this service. Leave the field empty if it is not involved in the VLAN.

The following table describes the codes used for the interface in this page:

Table 16-2. IGMP Port/LAG Members Table Control Settings

Port Control	Definition
S	Attaches the port to the Multicast group as static member in the static row. The port/LAG has joined the Multicast group statically in the current row.
F	Forbidden. The port cannot belong to the Multicast group.
Blank	The port is not attached to a Multicast group, but it is also not forbidden.

Managing Bridge Multicast Groups Using CLI Commands

The following table summarizes the CLI commands for managing Multicast service members as displayed in the **Bridge Multicast Group** pages.

Table 16-3. Bridge Multicast Group CLI Commands

CLI Command	Description
bridge multicast address { <i>mac-multicast-address</i> / <i>ip-multicast-address</i> }	Registers MAC-layer Multicast addresses to the bridge table, and adds static ports to the group.
no bridge multicast filtering	Use the no form of this command to disable Multicast address filtering.
bridge multicast forbidden address { <i>mac-multicast-address</i> / <i>ip-multicast-address</i> }[add remove] { [<i>gigabitethernet</i> <i>tengigabitethernet</i>] <i>interface-list</i> port-channel <i>LAG-number-list</i> }	Forbids adding a specific Multicast address to specific ports. Use the no form of this command to return to default
no bridge multicast forbidden address { <i>mac-multicast-address</i> }	Use the no form of this command to restore the default configuration.
show bridge multicast address-table [vlan <i>vlan-id</i>] [address { <i>mac-multicast-address</i> <i>ip-multicast-address</i> }] [format <i>ip</i> <i>mac</i>]	Displays Multicast MAC address table information.

The following is an example of the CLI commands:

```

console(config-if)# bridge multicast address 0100.5e02.0203
add gil/0/11,gil/0/12
console(config-if)# end
console # show bridge multicast address-table

VLAN      MAC Address          Type          Ports
----      -
1         0100.5e02.0203      static       gil/0/11,
                                                gigil/0/12

Forbidden ports for multicast addresses:

```

VLAN	MAC Address	Ports
----	-----	-----
1	0100.5e02.0203	gil/0/8
19	0100.5e02.0208	gil/0/8

console # **show bridge multicast address-table format ip**

VLAN	IP Address	Type	Ports
----	-----	----	-----
1	224-239.130 2.2.3	static	gil/0/11, gil/0/12

Forbidden ports for multicast addresses:

VLAN	IP Address	Ports
----	-----	-----
1	224-239.130 2.2.3	gil/0/8

Bridge Multicast Forward All

Use the **Bridge Multicast Forward All** page to attach ports or LAGs to a device that is attached to a neighboring Multicast router/switch. After IGMP Snooping is enabled, Multicast packets are forwarded to the appropriate port or VLAN.

To attach interfaces to a Multicast service:

- 1 Click **Switching > Multicast Support > Bridge Multicast Forward All** in the tree view to display the **Bridge Multicast Forward All** page.

Figure 16-3. Bridge Multicast Forward All

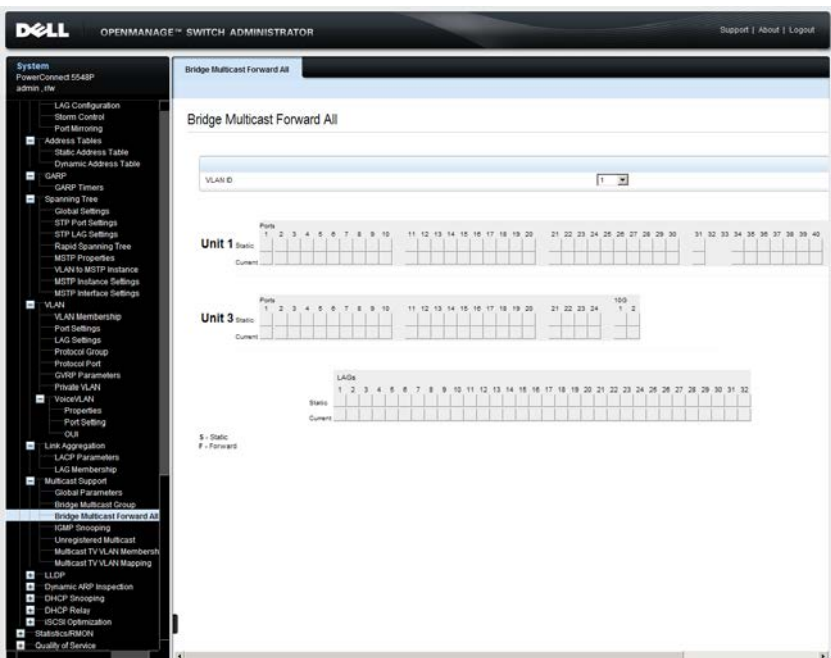

- 2 Select a unit/VLAN and click on the ports and LAGs to be attached to the Multicast service. Toggle a port to **S** to join the port to the selected Multicast group as a static port. Toggle a port to **F** to add it as a Forbidden port.

Two rows of ports and LAGs are displayed:

- **Static** — Displays available static ports/LAGs. These port/LAGs can be included or excluded from the Multicast groups, as described below.
- **Current** — Displays status of ports/LAGs, as actually applied, in the Multicast group.

Managing LAGs and Ports Attached to Multicast Routers Using CLI Commands

The following table summarizes the CLI commands for managing LAGs and ports attached to Multicast routers as displayed on the **Bridge Multicast Forward All** page.

Table 16-4. Managing LAGs and Ports Attached to Multicast Routers CLI Commands

CLI Command	Description
<code>show bridge multicast filtering vlan-id</code>	Displays the Multicast filtering configuration.
<code>bridge multicast forward-all {add remove} {[gigabitethernet tengigabitethe rnet] interface-list port- channel LAG-number-list}</code>	Enables forwarding of all Multicast packets on a port. Use the no form of this command to return to default.

The following is an example of the CLI commands:

```

console(config)# interface vlan 1
console(config-if)# bridge multicast forward-all add
gil/0/3
console(config-if)# end
console# show bridge multicast filtering 1
Filtering: Enabled
VLAN:          Forward-All
Port           Static              Status
-----
gil/0/11      Forbidden              Filter
gil/0/12      Forward                Forward(s)
gil/0/13      -                      Forward(d)

```

IGMP Snooping

IGMP Snooping can be enabled globally, as described in the **Global Parameters** page. It can also be enabled per VLAN to support selective IPv4 Multicast forwarding. In this case, Bridge Multicast filtering must also be enabled.

By default, a Layer 2 switch forwards Multicast frames to all ports of the relevant VLAN, essentially treating the frame as if it were a Broadcast. When IGMP Snooping is enabled per VLAN, the switch forwards Multicast frames to ports that have registered as Multicast clients in the VLAN.



NOTE: The switch supports IGMP Snooping only on static VLANs. It does not support IGMP Snooping on dynamic VLANs.

The IGMP Snooping Querier is used to support a Layer 2 Multicast domain of snooping switches in the absence of a Multicast router, for example, where Multicast content is provided by a local server, but the router (if one exists) on that network does not support Multicast.

There should only be a single IGMP Querier in a Layer 2 Multicast domain. The switch supports standards-based IGMP Querier election when more than one IGMP Querier is present in the domain.

The speed of IGMP Querier activity should be aligned with the IGMP-snooping-enabled switches. Queries should be sent at a rate that is aligned to the snooping table aging time. If queries are sent at a rate lower than the aging time, the subscriber cannot receive the Multicast packets.

To enable IGMP Snooping on a VLAN:

- 1 Click **Switching > Multicast Support > IGMP Snooping** in the tree view to display the **IGMP Snooping** page.

Figure 16-4. IGMP Snooping

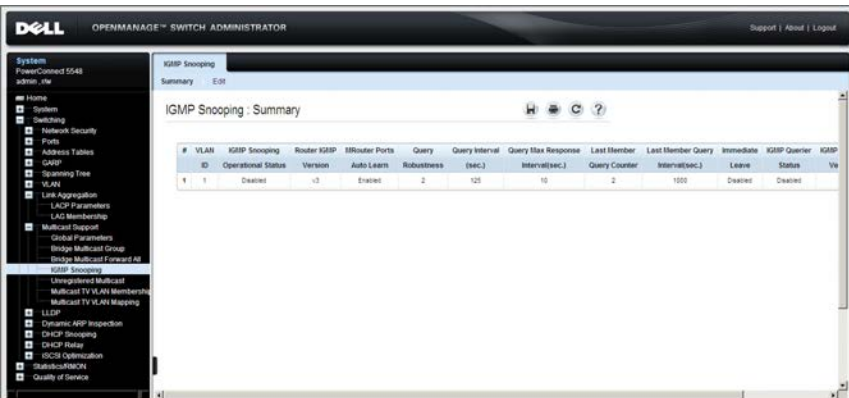

The IGMP snooping information for the VLANs on the switch is displayed.

- 2 To enable IGMP Snooping on a VLAN, click **Edit** and select the VLAN from the **VLAN ID** drop down menu.

3 Enter the fields:

- **IGMP Snooping Status** — Enable/disable the monitoring of network traffic to determine which hosts have asked to be sent Multicast traffic. The switch performs IGMP snooping only if IGMP snooping and Bridge Multicast filtering are both globally enabled.
- **Operational IGMP Snooping Status** — Displays whether IGMP Snooping is enabled.
- **MRouter Ports Auto Learn** — Enables or disables auto learning of the ports to which the Mrouter is connected.
- **Query Robustness (1-7)** — Enter the Robustness variable value to be used. The Robustness value enables tuning for the expected packet loss on a link. If a link is expected to have losses, the Robustness Value may be increased.
- **Operational Query Robustness** — Displays the robustness variable sent by the elected querier.
- **Query Interval (30-18000)** — Enter the interval between general queries sent by the querier .
- **Operational Query Interval** — The time interval in seconds between general queries sent by the elected querier
- **Query Max Response Interval (5-20)** — Enter the amount of time in which a host should respond to a query.
- **Operational Query Max Response Interval** — Displays the actual delay.
- **Last Member Query Counter (1-7)** — Enter the number of IGMP group-specific queries sent before the switch assumes there are no local members. To use the default, check **Use Default**.
- **Operational Last Member Query Counter** — Displays the operational value of the Last Member Query counter.
- **Last Member Query Interval (100-25500)** — Enter the time between two consecutive group-specific queries that are sent by the querier.
- **Operational Last Member Query Interval** — Displays the Last Member Query Interval sent by the elected querier.
- **Intermediate Leave** — Enable/disable an immediate timeout period. The default timeout is 10 seconds.

- **IGMP Querier Status** — Enables or disables the IGMP Querier. The IGMP Querier simulates the behavior of a Multicast router, enabling snooping of the Layer 2 Multicast domain even though there is no Multicast router.
- **Querier Source IP Address** — Select the IP address of the IGMP Querier. Use either the VLAN's IP address or define a unique IP address that will be used as a source address of the querier.
- **Operational Source Querier IP Address** — Operational Querier IP address.

Configuring IGMP Snooping Using CLI Commands

The following table summarizes the CLI commands for configuring IGMP snooping on a VLAN:

Table 16-5. IGMP Snooping CLI Commands

CLI Command	Description
<code>ip igmp snooping vlan <i>vlan-id</i></code>	Enables IGMP snooping on a specific VLAN.
<code>no ip igmp snooping vlan <i>vlan-id</i></code>	Use the no form of this command to disable IGMP snooping on a VLAN interface.
<code>ip igmp snooping vlan <i>vlan-id</i> mrouter learn pim-dvmrp</code>	Enables automatic learning of Multicast router ports in the context of a specific VLAN.
<code>no ip igmp snooping vlan <i>vlan-id</i> mrouter learn pim-dvmrp</code>	Use the no form of this command to remove the configuration.
<code>ip igmp robustness <i>count</i></code>	Changes the value of the IGMP robustness variable.
<code>no ip igmp robustness</code>	Use the no format of the command to return to default.
<code>ip igmp query-interval <i>seconds</i></code>	Configures the Query interval.
<code>no ip igmp query-interval</code>	Use the no format of the command to return to default.

Table 16-5. IGMP Snooping CLI Commands (Continued)

CLI Command	Description
ip igmp query-max-response-time <i>seconds</i>	Configures the Query Maximum Response time.
no ip igmp query-max-response-time	Use the no format of the command to return to default.
ip igmp last-member-query-count <i>count</i>	Configures the Last Member Query Counter.
no ip igmp last-member-query-count	Use the no format of the command to return to default.
ip igmp snooping vlan <i>vlan-id</i> immediate-leave	Enables the IGMP Snooping Immediate-Leave processing on a VLAN.
no ip igmp snooping vlan <i>vlan-id</i> immediate-leave	Use the no format of the command to disable IGMP Snooping Immediate-Leave processing.
ip igmp snooping vlan <i>vlan-id</i> querier	Enables the IGMP querier on a specific VLAN.
no ip igmp snooping vlan <i>vlan-id</i> querier	Use the no form of this command to disable the IGMP querier on a VLAN interface.
ip igmp snooping querier address <i>source-ip-address</i>	Defines the source IP address that the IGMP Snooping querier would use.
no ip igmp snooping querier address	Use the no form of this command to return to default.
show ip igmp snooping groups [<i>vlan vlan-id</i>] [<i>address ip-multicast-address</i>]	Displays the Multicast groups learned by IGMP snooping.
show ip igmp snooping interface <i>vlan-id</i>	Displays IGMP snooping configuration.
show ip igmp snooping mrouter [<i>interface vlan-id</i>]	Displays information about dynamically learned Multicast router interfaces.

The following is an example of the CLI commands:

```
console (config)# ip igmp snooping
console (config)# interface vlan 1
console (config-if)# ip igmp snooping mrouter learn-pim-dvmrp
console (config)# interface vlan 1
console (config-if)# ip igmp snooping leave-time-out 60
console # do show ip igmp snooping groups
VLAN IP Address          Querier      Ports
---- -
1     224-239.130         |2.2.3 Yes   gil/0/1, gil/0/2
console # show ip igmp snooping interface 1
IGMP Snooping is globally disabled
IGMP Snooping admin: Enabled
IGMP Snooping oper mode: Disabled
Routers IGMP version: 3
IGMP snooping querier admin: disabled
IGMP snooping querier oper: disabled
IGMP snooping querier address admin:
IGMP snooping querier address oper: 10.5.234.232
IGMP snooping robustness: admin 2 oper 2
IGMP snooping query interval: admin 125 sec oper 125 sec
IGMP snooping query maximum response: admin 10 sec oper 10 sec
IGMP snooping last member query counter: admin 2 oper 2
IGMP snooping last member query interval: admin 1000 msec oper
1000 msec
IGMP snooping last immediate leave: disable
Automatic learning of Multicast router ports is enabled
```

Unregistered Multicast

Multicast frames are generally forwarded to all ports in the VLAN. If IGMP Snooping is enabled, the device learns about the existence of Multicast groups and tracks which ports have joined what Multicast group.

Multicast groups can also be statically enabled. This enables the device to forward the Multicast frames (from a registered Multicast group) only to ports that are registered to that Multicast group.

Traffic from unregistered Multicast groups, which are the groups that are not known to the device, can either be filtered or forwarded. After a port has been set to Forwarding/Filtering, its configuration is valid for any VLAN of which it is a member (or will be a member of).

To set the action for unregistered Multicast groups on a port:

- 1 Click **Switching > Multicast Support > Unregistered Multicast** in the tree view to display the **Unregistered Multicast: Summary** page.

Figure 16-5. Unregistered Multicast: Summary

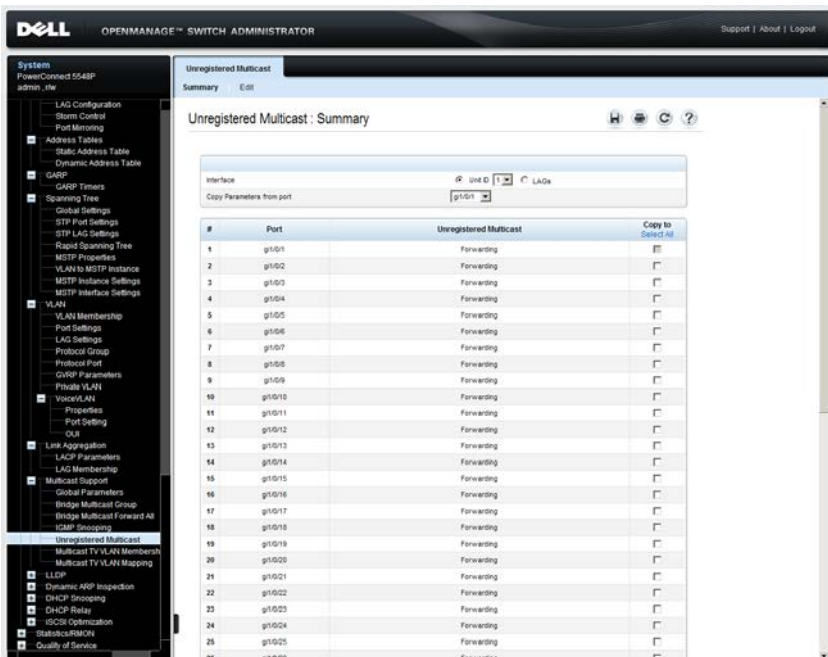

The action for each port is displayed.

- 2 To modify the forwarding action for an interface, click **Edit**, and enter the fields.
 - **Interface** — Select a port or LAG.
 - **Unregistered Multicast** — Select the forwarding status of the selected interface. The possible options are:
 - **Forwarding** — Enables forwarding of unregistered Multicast frames on the selected port or port-channel.
 - **Filtering** — Enables filtering of unregistered Multicast frames on the selected VLAN interface.

Configuring Unregistered Multicast Using CLI Commands

The following table summarizes the CLI commands for configuring Unregistered Multicast on the device:

Table 16-6. Unregistered Multicast CLI Commands

CLI Command	Description
<code>bridge multicast unregistered</code>	Configures the forwarding state of unregistered multicast addresses.
<code>show bridge multicast unregistered</code>	Displays the unregistered multicast filtering configuration.

The following is an example of the CLI commands:

```
console # show bridge multicast unregistered
Port      Unregistered
-----  -
gil/0/1   Forward
gil/0/2   Filter
gil/0/3   Filter
```

Multicast TV VLAN

This section describes the Multicast TV VLAN feature.

It contains the following sections:

- Multicast TV VLAN Overview
- Multicast TV VLAN Membership
- Multicast TV VLAN Mapping

Multicast TV VLAN Overview

The Multicast TV VLAN feature provides the ability to supply Multicast transmissions to Layer 2-isolated subscribers, without replicating the Multicast transmissions for all subscriber VLANs. The subscribers are the only receivers of the Multicast transmissions.

- A Multicast TV VLAN can be defined for an Access port (a port that is in Access mode for VLAN membership).
- All static VLANs are permitted to be a Multicast-TV VLAN.
- The configuration is performed per port.

One or more IP Multicast address groups can be associated with a Multicast VLAN. The source port must belong to the Multicast VLAN. Source and receiver ports do not have to be members of the same VLAN.

An end port is defined as a receiver port for the Multicast VLAN. Receiving ports can belong to a single user VLAN and additionally to one Multicast VLAN. The receiver port can be an access member in any VLAN, but not in the defined Multicast VLAN. In Multicast VLAN, the receiver port can only receive traffic and not send traffic on it. Receivers of same Multicast VLAN are isolated in different User (Access port) VLANs and therefore isolated from each other.

If a Multicast-TV VLAN is defined on an access port, then:

- The access port joins the Multicast-TV VLAN.
- The Multicast-TV VLAN on the receiver port is always untagged.
- The acceptable frame type of the port is set to Admit Untagged Only.

Multicast TV VLAN Membership

To view Multicast TV VLANs:

- Click **Switching > Multicast Support > Multicast TV VLAN Membership** in the tree view to display the **Multicast TV VLAN Membership** page.

Figure 16-6. Multicast TV VLAN Membership

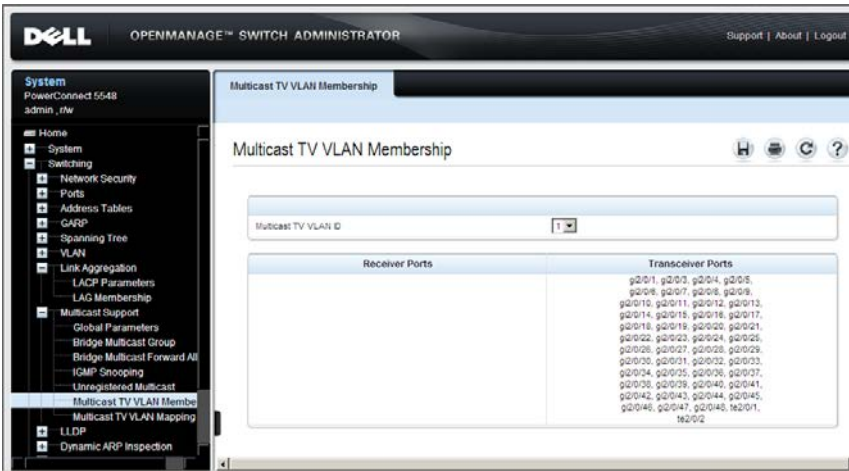

The receiver and transceiver ports in the selected TV VLAN are displayed.

Displaying Multicast TV VLAN Membership Using CLI Commands

The following table summarizes the CLI command for displaying Multicast TV VLAN membership:

Table 16-7. Multicast TV VLAN Membership CLI Commands

CLI Command	Description
<code>show vlan multicast-tv vlan <i>vlan-id</i></code>	Displays information on the source ports and receiver ports of multicast-TV VLAN.

The following is an example of the CLI commands:

```
console # show vlan multicast-tv vlan 1
Source Ports
-----
gil/0/8, gil/0/9
Receiver Ports
-----
gi2/0/1-18, gi3/0/1-18, gi4/0/1-18
```

Multicast TV VLAN Mapping

To set the Multicast Group IP address for a TV VLAN:

- 1 Click **Switching > Multicast Support > Multicast TV VLAN Mapping** in the tree view to display the **Multicast TV VLAN Mapping: Summary** page.

Figure 16-7. Multicast TV VLAN Mapping: Summary

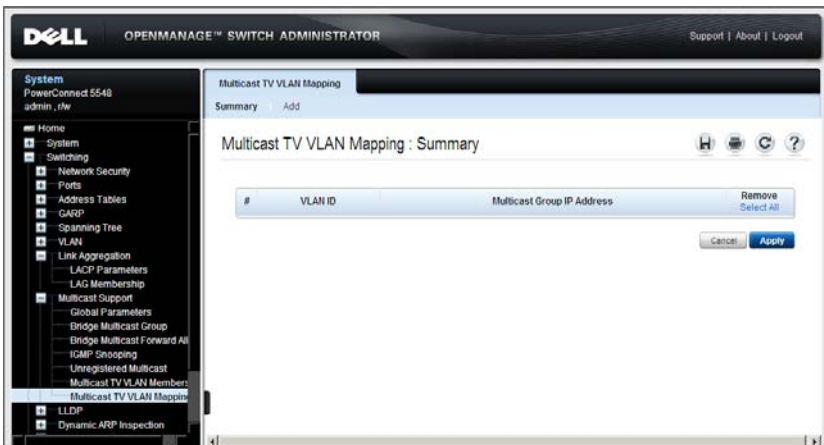

The Multicast Group IP addresses for the selected TV VLAN are displayed.

- 2 To add the Multicast Group IP address for a VLAN, click **Add**, and enter the fields:
 - **VLAN ID** — Enter a VLAN ID.

- **Multicast Group IP Address** — Enter the Multicast group IP address for which the IGMP Snooping is enabled.

Mapping Multicast TV VLANs to IP Addresses Using CLI Commands

The following table summarizes the CLI command for mapping Multicast TV VLANs to Multicast IP addresses:

Table 16-8. Unregistered Multicast CLI Commands

CLI Command	Description
<code>ip igmp snooping vlan vlan-id multicast-tv ip-multicast-address [count number]</code>	Defines the Multicast IP addresses that are associated with a Multicast-TV VLAN.
<code>no ip igmp snooping vlan vlan-id multicast-tv ip-multicast-address [count number]</code>	Use the no form of this command to remove all associations.
<code>show ip igmp snooping multicast-tv [vlan vlan-id]</code>	Displays the IP addresses associated with Multicast TV VLANs.

The following is an example of the CLI commands:

```
console# show ip igmp snooping multicast-tv
VLAN IP Address
----
1000 239.255.0.0
1000 239.255.0.1
1000 239.255.0.2
1000 239.255.0.3
1000 239.255.0.4
1000 239.255.0.5
```

LLDP

The section describes the Link Layer Discovery Protocol (LLDP). It contains the following topics:

- LLDP Overview
- LLDP Properties
- LLDP Port Settings
- MED Network Policy
- LLDP MED Port Settings
- Neighbors Information

LLDP Overview

The Link Layer Discovery Protocol (LLDP) enables network managers to troubleshoot and enhance network management by discovering and maintaining network topologies over multi-vendor environments. LLDP discovers network neighbors by standardizing methods for network devices to advertise themselves to other systems, and to store discovered information. Discovery information includes:

- Device identification
- Device capabilities
- Device configuration

The advertising device transmits multiple advertisement message sets in a single LAN packet. The multiple advertisement message sets are sent in the packet's Type Length Value (TLV) field.

LLDP devices must support chassis and port ID advertisements, as well as system name, system ID, system description, and system capability advertisements.

LLDP Media Endpoint Discovery (LLDP-MED) increases network flexibility by enabling various IP systems to co-exist on a single network, and provides the following features:

- Detailed network topology information, including information on which devices are located on the network and where the devices are located, for example, which IP phone is connect to which port, which software is running on which switch, and which port is connected to which device.
- Automatic deployment of policies over networks for:
 - QoS Policies
 - Voice VLANs
- Emergency Call Service (E-911) via IP phone location information.
- Troubleshooting information. LLDP MED sends network managers alerts for:
 - Port speed and duplex mode conflicts
 - QoS policy misconfigurations

LLDP Properties

To enable and configure LLDP:

- 1 Click **System > LLDP > LLDP Properties** in the tree view to display the LLDP Properties page.

Figure 17-1. LLDP Properties

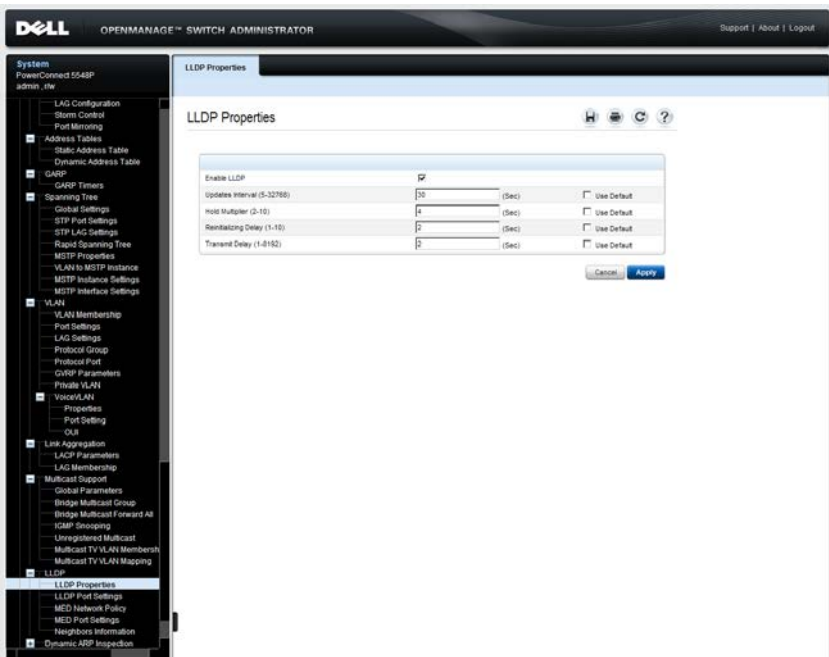

The current LLDP properties are displayed.

- 2 Enter the fields:
 - **Enable LLDP** — Enable/disable LLDP on the device.
 - **Updates Interval (5-32768)** — Enter the rate at which LLDP advertisement updates are sent.
 - **Hold Multiplier (2-10)** — Enter the hold time to be sent in the LLDP update packets, as a multiple of the timer value.

- **Reinitializing Delay (1-10)** — Enter the minimum time, in seconds, that an LLDP port waits before reinitializing LLDP transmission.
- **Transmit Delay (1-8192)** — Enter the amount of time that passes between successive LLDP frame transmissions, due to changes in the LLDP local systems MIB.

To use the default values for any field, select **Use Default**.

Configuring LLDP Using CLI Commands

The following commands are used to set the fields in the **LLDP Properties** page.

Table 17-1. LLDP Properties CLI Commands

CLI Command	Description
<code>lldp run</code>	Enables enable LLDP.
<code>no lldp run</code>	Use the no form of this command to disable LLDP.
<code>lldp timer <i>seconds</i></code>	Specifies how often the software sends LLDP updates.
<code>no lldp timer</code>	Use the no form of this command to restore the default configuration.
<code>lldp hold-multiplier <i>number</i></code>	Specifies the time that the receiving device should hold a Link Layer Discovery Protocol (LLDP) packet before discarding it.
<code>no lldp hold-multiplier</code>	Use the no form of this command to restore the default configuration.
<code>lldp reinit <i>seconds</i></code>	Specifies the minimum time an LLDP port will wait before reinitializing.
<code>no lldp reinit</code>	Use the no form of this command to revert to the default setting.
<code>lldp tx-delay <i>seconds</i></code>	Specifies the delay between successive LLDP frame transmissions.
<code>no lldp tx-delay</code>	Use the no form of this command to restore the default configuration.

The following is an example of the CLI commands:

```
console(config)# interface gil/0/1
console(config-if)# lldp run
console(config)# lldp timer 30
console(config)# lldp hold-multiplier 3
console(config)# lldp reinit 4
```

LLDP Port Settings

LLDP configuration of a port includes activating LLDP notification on it, and selecting the optional TLVs that will be sent in the LLDP PDU, in addition to the mandatory ones.

By setting these properties, it is possible to provide additional types of information to those network devices that support the LLDP.

To configure LLDP per port:

- 1 Click **System > LLDP > LLDP Port Settings** in the tree view to display the **LLDP Port Settings: Summary** page.

Figure 17-2. LLDP Port Settings: Summary

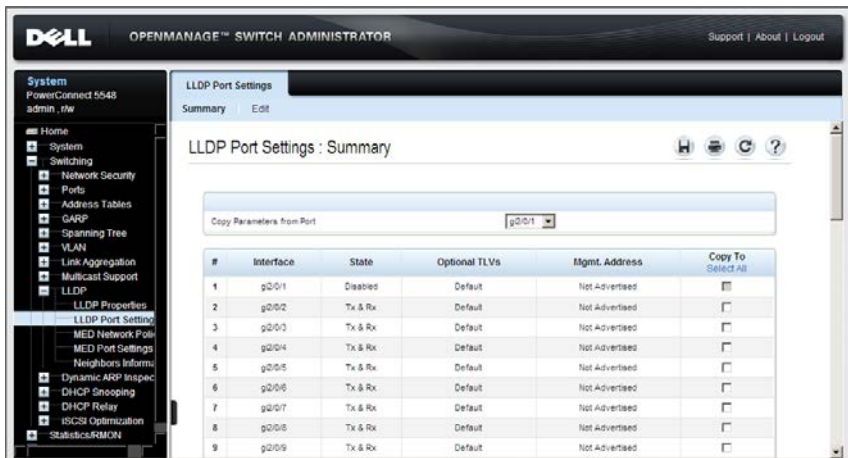

LLDP settings for all ports are displayed.

- 2 To modify the LLDP settings for a port, click **Edit** and select the port to be configured.
- 3 Select the transmission type on which LLDP is to be configured in the **State** field. The possible options are:
 - **Tx Only** — Enables LLDP on transmitting LLDP packets only.
 - **Rx Only** — Enables LLDP on receiving LLDP packets only.

- **Tx & Rx** — Enables LLDP on transmitting and receiving LLDP packets.
 - **Disable** — LLDP is disabled on the port.
- 4** Move the optional TLVs that the switch should advertise from the **Available TLV** list to the **Optional TLV** list. The TLVs advertise the following:
- **Port Description** — Information about the port, including manufacturer, product name, and hardware/software version.
 - **System Name** — System's assigned name (in alpha-numeric format). This value equals the sysName object.
 - **System Description** — Description of the network entity (in alpha-numeric format). This includes the system's name and versions of the hardware, operating system, and networking software supported by the switch. This value equals the sysDescr object.
 - **System Capabilities** — Primary functions of the switch, and whether or not these functions are enabled in the switch. The capabilities are indicated by two octets. Bits 0 through 7 indicate Other, Repeater, Bridge, WLAN AP, Router, Telephone, DOCSIS cable device, and station respectively. Bits 8 through 15 are reserved.
 - **802.3 MAC-PHY** — Duplex and bit rate capability and the current duplex and bit rate settings of the sending device. It also advertises whether the current settings are due to auto-negotiation or manual configuration.

An alternative way to select the TLVs is to select the **Use Default** field, in which case only mandatory TLVs are used. These are: Chassis subtype (MAC address), Port subtype (port number), and TTL (time-to-leave).

- 5** Enter the **Management IP Address** that is advertised from the interface. Check **Use Default** to use the default Management IP address.

Configuring LLDP Port Settings Using CLI Commands

The following commands are used to configure LLDP on ports.

Table 17-2. LLDP Port Settings CLI Commands

CLI Command	Description
<code>lldp transmit</code>	Enables transmitting LLDP on an interface.
<code>no lldp transmit</code>	Use the no form of this command to stop transmitting LLDP on an interface.
<code>lldp receive</code>	Enables receiving LLDP on an interface.
<code>no lldp receive</code>	Use the no form of this command to stop receiving LLDP on an interface.
<code>lldp optional-tlv tlv1 [tlv2 ... tlv5]</code>	Specifies which optional TLVs from the basic set should be transmitted

The following is an example of the CLI commands:

```
console(config)# interface gi1/0/1
console(config-if)# lldp transmit
console(config-if)# lldp receive
console(config-if)# lldp optional-tlv port-desc
```

MED Network Policy

An LLDP-MED network policy is a set of configuration settings that is identified by a network policy number. Policies are loaded into LLDP-MED TLVs, and sent to devices connected to the switch. A network policy instructs the connected device as to how to send traffic, for example, a policy can be created for VoIP phones that instructs them to:

- Send voice traffic on VLAN 10
- Tag voice traffic with DSCP=63
- Transmit data-traffic to the switch (from the PC connected to the switch through the VoIP phone) without modification to traffic sent by the PC (typically, Untagged).

For network policies to be implemented, they must be created and then associated with ports.

Before policies are defined, the administrator must create the VLANs, and configure memberships in the VLANs, based on the specification in the LLDP-MED network policies.

To add a MED network policy:

- 1 Click **System > LLDP > MED Network Policy** in the tree view to display the **MED Network Policy: Summary** page.

Figure 17-3. MED Network Policy: Summary

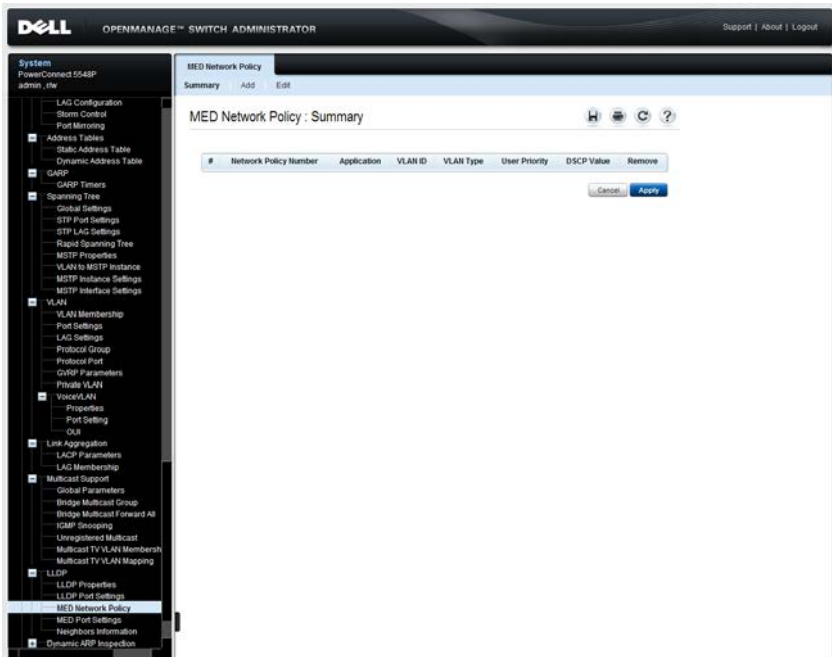

Previously-defined network policies are displayed.

- 2 To add a network policy, click **Add**, and enter the fields:
 - **Network Policy Number** — Select an available network policy number.
 - **Application** — Select the application (type of traffic) for which the network policy is defined.
 - **VLAN ID** — Enter the VLAN ID to which the traffic should be sent.
 - **VLAN Type** — Select whether the traffic is Tagged or Untagged.

- **User Priority** — Select the traffic priority assigned to the network application.
- **DSCP Value** — Select the value to be used by neighbors to mark the traffic sent to the switch.

Configuring MED Network Policies Using CLI Commands

The following commands are used to configure MED network policies.

Table 17-3. LLDP MED Network Policies CLI Commands

CLI Command	Description
<code>lldp med network-policy number application [vlan id] [vlan-type {tagged untagged}] [up priority][dscp value]</code>	Defines an LLDP MED network policy.
<code>no lldp med network-policy number</code>	Use the no form of this command to remove an LLDP MED network policy.

The following is an example of the CLI commands:

```
console(config)# lldp med network-policy 1 voice-signaling
vlan 1
```

LLDP MED Port Settings

To assign MED network policies to ports:

- 1 Click **System > LLDP > MED Port Settings** in the tree view to display the **MED Port Settings: Summary** page.

Figure 17-4. MED Port Settings: Summary

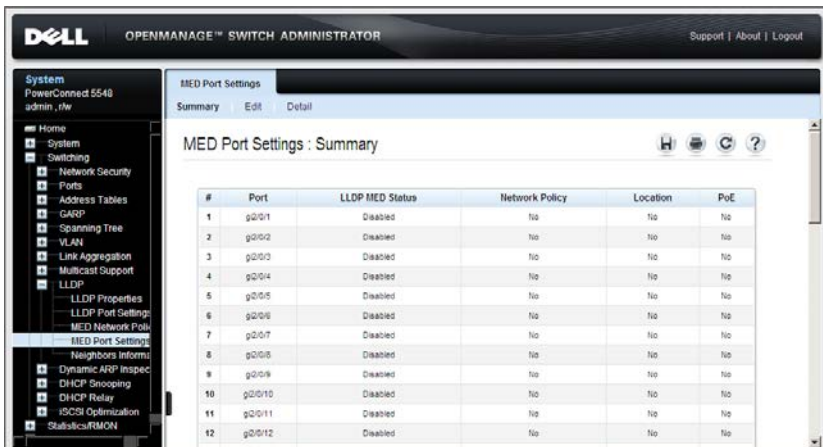

- 2 Select the unit in the stack. All ports on that unit are displayed along with the following fields:
 - **LLDP MED Status** — Specifies if LLDP-MED is enabled on the selected port.
 - **Network Policy** — Specifies whether a network policy is assigned to the port.
 - **Location** — Specifies whether the location is advertised.
 - **PoE** — Specifies whether PoE is enabled on the port.
- 3 To modify network policies on a port, click **Edit**.
- 4 Select the port to be configured, and enter the fields for the port:
 - **Enable LLDP-MED** — Enable/disable LLDP-MED on the port.

- **Available TLVs** — Contains a list of available TLVs that can be advertised by the port. The possible options are:
 - **Network Policy** — Advertises the network policy attached to the port.
 - **Location** — Advertises the port's location.
 - **PoE-PSE** — Indicates if the connected media is a PoE or PSE (Power Sourcing Equipment) device.

Move the TLVs to be published to the **Tx Optional TLVs** list.

- **Available Network Policy** — Contains a list of network policies that can be assigned to a port. Move the network policies to be assigned to the port to the **Network Policy** list.
- **Location Coordinate (16 Bytes in Hex)** — Displays the device's location map coordinates.
- **Location Civic Address (6-160 Bytes in Hex)** — Displays the device's civic or street address location, for example 414 23rd Ave E.
- **Location ECS ELIN (10-25 Bytes in Hex)** — Displays the device's ECS ELIN location.

5 To view MED details for a port, click **Details** and select a port.

The following fields are displayed for the port:

- **Auto-Negotiation Status** — Enabled specifies that auto-negotiation is enabled on the port; Disabled indicates that it is not.
- **Advertised Capabilities** — The list of port capabilities advertised for the port.
- **MAU Type** — The Media Attachment Unit type. The MAU performs physical layer functions, including digital data conversion from the Ethernet interfaces' collision detection and bit injection into the network, for example, 100BASE-TX full duplex mode.
- **System Name** — The system's assigned name (in alpha-numeric format). This value equals the sysName object.
- **System Description** — A description of the network entity (in alpha-numeric format). This includes the system's name and versions of the hardware, operating system, and networking software supported by the switch. This value equals the sysDescr object.

- **Device ID** — The device ID advertised, for example, the device MAC address.
- **Device Type** — The type of device.
- **LLDP MED Capabilities** — The TLVs that are advertised by the port.
- **LLDP MED Device Type** — Specifies whether a sender is a network connectivity device or an endpoint device.
- **Application** — The following fields are displayed for each possible application type:
 - **Application Type** — The application type.
 - **Flags** — The VLAN tagging status for the application type: Tagged or Untagged.
 - **VLAN ID** — The VLAN number for the application type.
 - **User Priority** — The user priority for the application type.
 - **DSCP** — The DSCP value assigned to the network policy.
- **Location Type** — Displays the port's LLDP location type:
 - **Coordinates** — Device's location map coordinates.
 - **Civic Address** — Device's civic or street address location, for example 414 23rd Ave E.
 - **ECS ELIN** — Device's ECS ELIN location.
- **Location Address** — Displays the port's LLDP location, according to the **Location Type**.

Configuring MED on Ports Using CLI Commands

The following commands are used to set the fields in the **MED Port Settings** pages.

Table 17-4. LLDP Properties CLI Commands

CLI Command	Description
<code>lldp med enable [tlv ... tlv4]</code>	Enables LLDP MED on an interface.
<code>no lldp med enable</code>	Use the no form of this command to disable LLDP MED on an interface.
<code>lldp med network-policy {add remove} number</code>	Attaches or removes an LLDP MED network policy on an interface.
<code>no lldp med network-policy number</code>	Use the no form of this command to remove all the LLDP MED network policies from the interface
<code>lldp med location {{coordinate data} {civic-address data} {ecs-elin data}}</code>	configure the LLDP MED for an interface.
<code>no lldp med location {coordinate civic-address ecs-elin}</code>	Use the no form of this command to delete location information for an interface.
<code>show lldp med configuration [gigabitethernet tengigabitethernet] port-number</code>	Displays the LLDP MED configuration for all interfaces or for a specific interface.
<code>show lldp local [gigabitethernet tengigabitethernet] port-number</code>	Displays the LLDP information that is advertised from a specific port.

The following is an example of the CLI commands:

```
console(config)# interface gil/0/3
console(config)# lldp med location civic-address 6162636465
console# show lldp med configuration
Fast Start Repeat Count: 4.
Network policy 1
-----
Application type: voiceSignaling
VLAN ID: 1 untagged
Layer 2 priority: 0
DSCP: 0
Port  Capabilities Network Location PoE Notif      Inventory
      Policy          ications
-----
gil/0/1 Yes          Yes      Yes      No  Enabled  No
gil/0/2 Yes          Yes      No       No  Enabled  No
```

Neighbors Information

Use the **Neighbors Information** page to view information that was received in LLDP advertisements from neighboring devices.

The neighbor's information is deleted after timeout. Timeout is the maximum interval that can pass without receiving an LLDP PDU from a neighbor. The timeout value is computed from the neighbor's Time to Live TLV.

To view neighbors information:

- 1 Click **System > LLDP > Neighbors Information** in the tree view to display the **Neighbors Information** page.

Figure 17-5. Neighbors Information

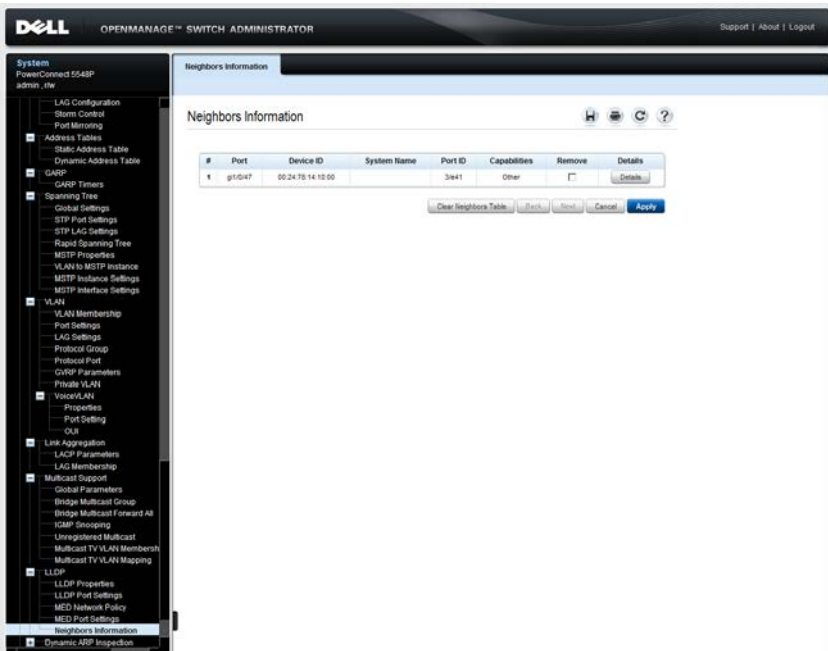

The following fields are displayed for each port on the device that has a discovered neighbor:

- **Port** — Port number for which neighboring information is displayed

- **Device ID** — Neighboring device ID
 - **System Name** — Name of the neighboring system
 - **Port ID** — Neighboring port ID
 - **Capabilities** — Neighboring device capabilities
- 2** Click **Clear Neighbors Table** to delete all the entries or select **Remove** to delete a specific port entry.
 - 3** Click the **Details** button of a port to display the **Neighbors Information: Details** page for that port.

In addition to the fields displayed in the **MED Port Settings: Details Advertise Information** page and the **Green Ethernet Configuration** pages, the following fields are displayed for the neighbors of the selected port:

- **Power Type** — Port's power type
- **Power Source** — Port's power source
- **Power Priority** — Port's power priority
- **Power Value** — Port's power value, in Watts
- **Hardware revision** — Hardware revision
- **Firmware revision** — Firmware revision
- **Software revision** — Software revision
- **Serial number** — Device serial number
- **Manufacturer name** — Device manufacturer name
- **Model name** — Device model name
- **Asset ID** — Asset ID

Configuring LLDP Neighbors Using CLI Commands

The following commands are used to configure LLDP neighbors.

Table 17-5. LLDP Neighbors Information CLI Commands

CLI Command	Description
<code>show lldp neighbors</code> <code>[gigabitethernet tengigabite</code> <code>thernet] port-number</code>	Displays information about neighboring devices discovered using LLDP

The following is an example of the CLI commands:

```
console# show lldp neighbors
```

Port	Device ID	Port ID	System Name	Capabilities	TTL
gi2/0/17	00:75:73:71:72:55	1/e21		0	91
gi2/0/33	00:12:cf:7c:63:a0	1/e1		0	92
gi2/0/33	00:11:22:11:22:33	1/g39		0	107
gi2/0/33	00:aa:aa:aa:aa:aa	1/e37		0	106
gi2/0/41	a4:ba:db:57:7c:8d	g13		0	97

Dynamic ARP Inspection

This section describes dynamic ARP inspection.

It contains the following topics:

- Dynamic ARP Inspection Overview
- Global Settings
- Dynamic ARP Inspection List
- Dynamic ARP Inspection Entries
- VLAN Settings
- Trusted Interfaces

Dynamic ARP Inspection Overview

ARP Inspection eliminates man-in-the-middle attacks, where false ARP packets are inserted into the subnet. ARP requests and responses are inspected, and their MAC-address-to-IP-address binding is checked according to the ARP Inspection List defined by the user (in the *Dynamic ARP Inspection List* and *Dynamic ARP Inspection Entries* pages). If the packet's IP address was not found in the ARP Inspection List, and DHCP Snooping is enabled for a VLAN, a search of the DHCP Snooping database is performed. See "How DHCP Snooping Works" on page 564 for an explanation of the DHCP Snooping database. If the IP address is found the packet is valid, and is forwarded.

Packets with invalid ARP Inspection bindings are logged and dropped.

Ports are classified as follows:

- Trusted — Packets are not inspected.
- Untrusted — Packets are inspected as described above.

The following additional validation checks may be configured by the user:

- Source MAC — Compares the packet's source MAC address in the Ethernet header against the sender's MAC address in the ARP request. This check is performed on both ARP requests and responses.
- Destination MAC — Compares the packet's destination MAC address in the Ethernet header against the destination interface's MAC address. This check is performed for ARP responses.
- IP Addresses — Compares the ARP body for invalid and unexpected IP addresses. Addresses include 0.0.0.0, 255.255.255.255, and all IP Multicast addresses.

Global Settings

To enable ARP inspection on the device:

- 1 Click **Switching > Dynamic ARP Inspection > Global Settings** in the tree view to display the **Global Settings** page.

Figure 18-1. Global Settings

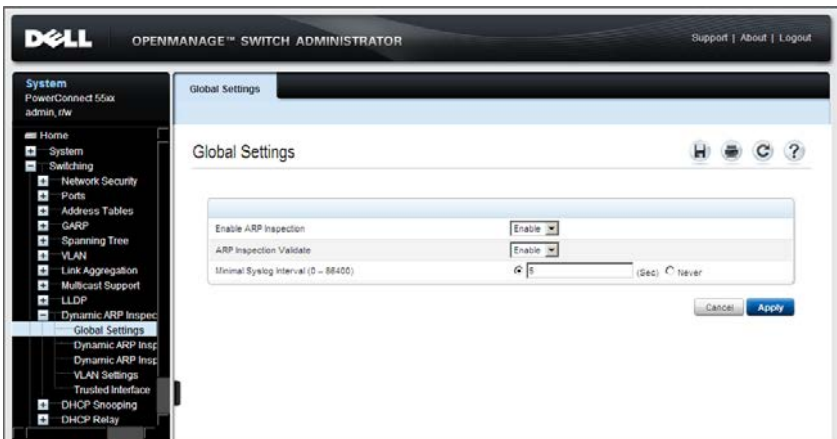

2 Enter the fields:

- **Enable ARP Inspection** — Enable/disable ARP inspection.
- **ARP Inspection Validate** — Enable/disable the following checking source MAC address, destination MAC address and IP addresses against the respective addresses in the ARP body.
- **Minimal Syslog Interval (0 – 86400)** — Enter the minimum time interval between successive ARP SYSLOG messages.

Setting Dynamic ARP Inspection Global Settings Using CLI Commands

The following table summarizes the CLI commands for configuring the fields in the Global Settings pages.

Table 18-1. ARP Inspection Global Settings CLI Commands

CLI Command	Description
<code>ip arp inspection</code>	Enables ARP inspection.
<code>no ip arp inspection</code>	Use the no form of this command to disable ARP inspection.
<code>ip arp inspection validate</code>	Performs specific checks for dynamic ARP inspection.
<code>no ip arp inspection validate</code>	Use the no form of this command to restore the default configuration.
<code>ip arp inspection logging interval {seconds infinite}</code>	Sets the minimum time interval between successive ARP SYSLOG messages.
<code>no ip arp inspection logging interval</code>	Use the no form of this command to restore the default configuration.

The following is an example of some of the CLI commands:

```
console(config)# ip arp inspection
console(config)# ip arp inspection validate
```

Dynamic ARP Inspection List

An ARP inspection list consists of entries where each entry is a pair of MAC/IP addresses.

To create a new ARP inspection list and add the first entry to it:

- 1 Click **Switching > Dynamic ARP Inspection > Dynamic ARP Inspection List** in the tree view to display the **Dynamic ARP Inspection List: Summary** page.

Figure 18-2. Dynamic ARP Inspection List: Summary

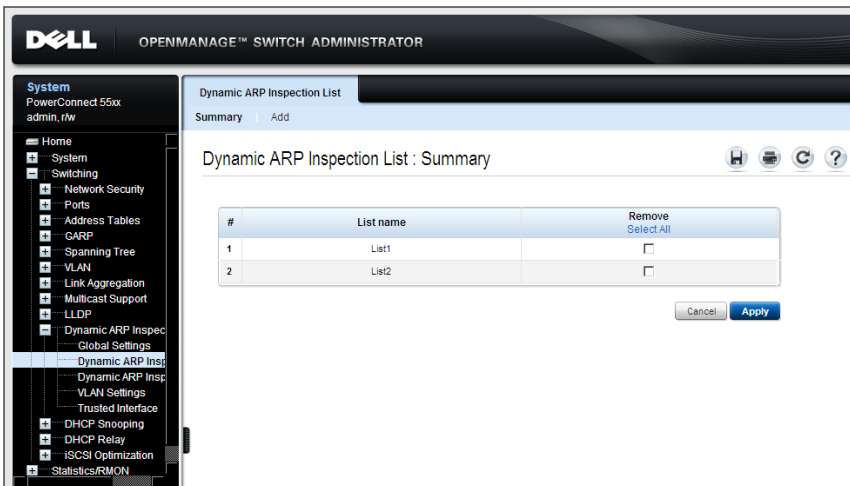

The dynamic ARP lists are displayed.

- 2 To create a new list and enter the first address pair in it, click **Add**, and enter the fields:
 - **List Name** — Create and enter a list name.
 - **IP Address** — Enter the IP address that will be mapped to the MAC address entered below.
 - **MAC Address** — Enter the MAC address that will be mapped to the IP address entered above.

Creating a Dynamic ARP Inspection List Using CLI Commands

The following table summarizes the CLI commands for configuring the fields in the **Dynamic ARP Inspection List** pages.

Table 18-2. Dynamic ARP Inspection List CLI Commands

CLI Command	Description
<code>ip arp inspection list create name</code>	Creates a static ARP binding list and enters the ARP list configuration mode.
<code>no ip arp inspection list create name</code>	Use the no form of this command to delete the list.

The following is an example of some of the CLI commands:

```
console(config)# ip arp inspection list create servers
console(config-ARP-list)#
```

Dynamic ARP Inspection Entries

To add additional addresses to the lists defined in the Dynamic ARP Inspection List page:

- 1 Click **Switching > Dynamic ARP Inspection Entries > Dynamic ARP Inspection Entries** in the tree view to display the **Dynamic ARP Inspection Entries: Summary** page.

Figure 18-3. Dynamic ARP Inspection Entries: Summary

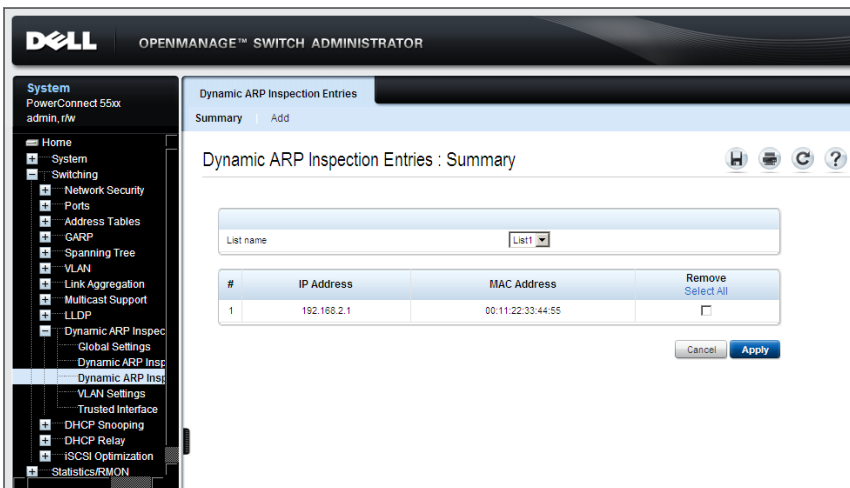

The dynamic ARP entries for the selected list are displayed.

- 2 To add a new address pair to a list, click **Add** and select the list.
- 3 Enter the fields:
 - **IP Address** — Enter the IP address that will be mapped to the MAC address entered below.
 - **MAC Address** — Enter the MAC address that will be mapped to the IP address entered above.

Adding Entries to a Dynamic ARP Inspection List Using CLI Commands

The following table summarizes the CLI commands for configuring the fields in the **Dynamic ARP Inspection Entries** pages.

Table 18-3. Dynamic ARP Inspection List Entries CLI Commands

CLI Command	Description
ip <i>ip-address</i> mac-address <i>mac-address</i>	Creates a static ARP binding. Use the no form of this command to
no ip <i>ip-address</i> mac-address <i>mac-address</i>	delete a static ARP binding..
show ip arp inspection list	Displays the static ARP binding list.

The following is an example of some of the CLI commands:

```
console(config)# ip arp inspection list create servers
console(config-arp-list)# ip 172.16.1.1 mac-address
0060.704c.7321
console(config-arp-list)# ip 172.16.1.2 mac-address
0060.704c.7322
console(config-arp-list)# do show ip arp inspection list
List name: servers
Assigned to VLANs:
IP                MAC
-----
172.16.1.1        00:60:70:4c:73:21
172.16.1.2        00:60:70:4c:73:22
console(config-arp-list)#
```

VLAN Settings

To assign a list of IP/MAC address pairs, defined in the **Dynamic ARP Inspection List** pages, to a VLAN:

- 1 Click **Switching > Dynamic ARP Inspection Entries > VLAN Settings** in the tree view to display the **VLAN Settings: Summary** page.

Figure 18-4. VLAN Settings: Summary

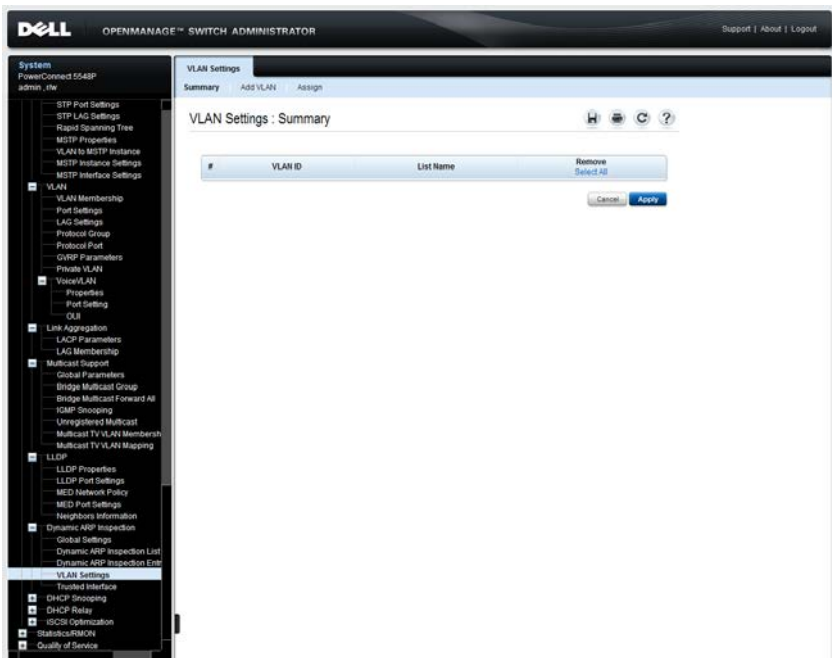

The VLANs and their associated lists of IP/MAC address pairs are displayed.

- 2 To designate a VLAN to be associated with an ARP inspection list, click **Add VLAN** and enter the VLAN ID.
- 3 Click **Assign** and select the **List Name** to be associated with the VLAN.

Assigning IP/MAC Address Pairs to VLANs Using CLI Commands

The following table summarizes the CLI commands for configuring the fields in the VLAN Settings pages.

Table 18-4. Assigning IP/MAC Address Pairs to VLANs CLI Commands

CLI Command	Description
<code>ip arp inspection vlan <i>vlan-id</i></code>	Enables ARP inspection on a VLAN, based on the DHCP Snooping database. Use the no form of this command to disable ARP inspection on a VLAN.
<code>ip arp inspection list assign <i>vlan-id name</i></code>	Assigns a static ARP binding list to a VLAN.
<code>no ip arp inspection list assign <i>vlan</i></code>	Use the no form of this command to delete the assignment.

The following is an example of some of the CLI commands:

```
console(config)# ip arp inspection list assign 37 servers
```

Trusted Interfaces

Interfaces are untrusted if the packet is received from an interface outside the network or from an interface beyond the network firewall. Trusted interfaces receive packets only from within the network or the network firewall.

To configure an interface to be trusted:

- 1 Click **Switching > Dynamic ARP Inspection > Trusted Interface** in the tree view to display the **Trusted Interface: Summary** page.

Figure 18-5. Trusted Interface: Summary

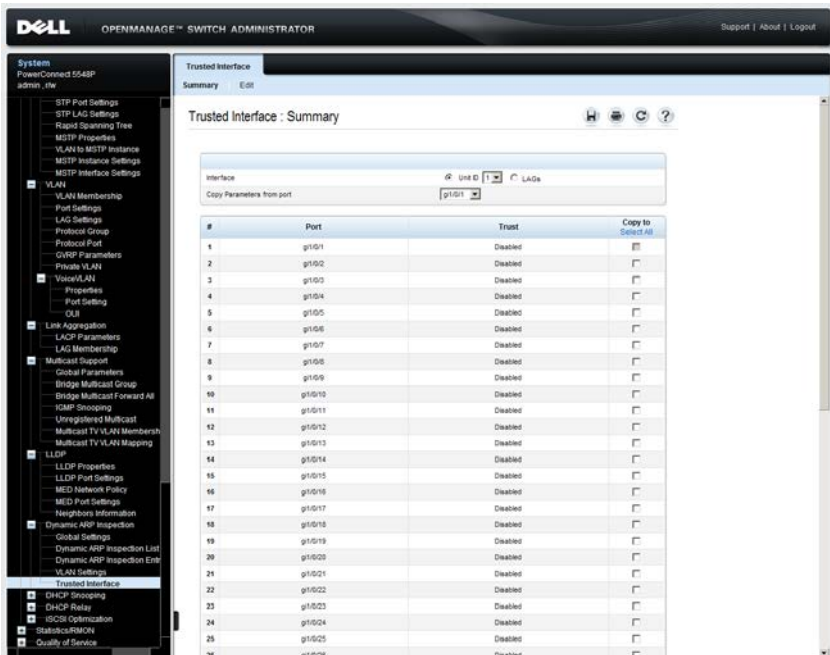

The ports on the selected unit and their trusted status are displayed.

- 2 To modify the status of an interface, click **Edit**.
- 3 Select the interface and enable/disable its **Trust Status**, which is the DHCP Snooping Trust mode.

Configuring Trusted Interfaces Using CLI Commands

The following table summarizes the CLI commands for configuring the fields in the Trusted Interface pages.

Table 18-5. Configuring Trusted Interface Parameters CLI Commands

CLI Command	Description
<code>ip arp inspection trust</code>	Configures an interface trust state that determines if incoming ARP packets are inspected. Use the no form of this command to restore the default configuration.
<code>no ip arp inspection trust</code>	
<code>show ip arp inspection</code> <code>[[gigabitethernet tengigabit ethernet] port-number port- channel LAG-number]</code>	Displays the ARP inspection configuration for all interfaces or a specific interface.

The following is an example of some of the CLI commands:

```
console(config)# interface gi1/0/3
console(config-if)# ip arp inspection trust
```

DHCP Snooping

This section describes DHCP Snooping and DHCP Relay features.

It contains the following topics:

- DHCP Snooping
- DHCP Relay

DHCP Snooping

This section describes DHCP snooping.

It contains the following topics:

- DHCP Snooping Overview
- Global Parameters
- VLAN Settings
- Trusted Interfaces
- Snooping Binding Database

DHCP Snooping Overview

DHCP snooping expands network security by providing layer security between untrusted interfaces and DHCP servers. By enabling DHCP snooping, network administrators can differentiate between trusted interfaces connected to end-users or DHCP Servers, and untrusted interfaces located beyond the network firewall.

How DHCP Snooping Works

DHCP snooping filters untrusted messages, and stores these messages in a database. Interfaces are untrusted if the packet is received from an interface outside the network, or from an interface beyond the network firewall. Trusted interfaces receive packets only from within the network or the network firewall.

The DHCP Snooping Binding database contains the untrusted interfaces' MAC address, IP address, Lease Time, VLAN ID, and interface information.

Table 21-1 describes how DHCP packets are handled when DHCP snooping is enabled on an interface.

Table 19-1. DHCP Packet Handling when DHCP Snooping is Enabled

Packet Type	Arriving from Untrusted Ingress Interface	Arriving from Trusted Ingress Interface
DHCPDISCOVER	Forward to trusted interfaces only.	Forwarded to trusted interfaces only.

Table 19-1. DHCP Packet Handling when DHCP Snooping is Enabled (Continued)

Packet Type	Arriving from Untrusted Ingress Interface	Arriving from Trusted Ingress Interface
DHCPOFFER	Filter.	Forward the packet according to DHCP information. If the destination address is unknown the packet is filtered.
DHCPREQUEST	Forward to trusted interfaces only.	Forward to trusted interfaces only.
DHCPACK	Filter.	Same as DHCPOFFER and an entry is added to the Binding database.
DHCPNAK	Filter.	Same as DHCPOFFER. Remove entry if exists.
DHCPDECLINE	Check if there is information in the database. If the information exists and does not match the interface on which the message was received, the packet is filtered. Otherwise the packet is forwarded to trusted interfaces only, and the entry is removed from database.	Forward to trusted interfaces only
DHCPRELEASE	Same as DHCPDECLINE.	Same as DHCPDECLINE.
DHCPINFORM	Forward to trusted interfaces only.	Forward to trusted interfaces only.
DHCPLEASEQUERY	Filtered.	Forward.

As shown in Table 21-1, the DHCP Snooping Binding database is updated by interception of DHCPACK, DHCPDECLINE and DHCPRELEASE packets, and is stored in non-volatile memory.

Even if a port is down, its entries are not deleted.



NOTE: Only DHCP requests on untrusted ports are maintained in the Binding database.

Limitations

The following limitations apply:

- Enabling DHCP snooping uses TCAM resources.
- The switch writes changes to the binding database only when the switch system clock is synchronized with SNTP.
- The switch does not update the Binding database when a station moves to another interface.

Global Parameters

Use the **Global Parameters** page to:

- Enable/disable DHCP snooping globally.
- Determine whether to forward or filter DHCP packets received from untrusted interfaces, whose source MAC address and the DHCP client MAC address do not match.
- Determine whether to forward or filter DHCP packets, received from untrusted interfaces, with option-82 information.
- Set Binding database update interval.

To configure DHCP snooping on the device:

- 1 Click **Switching > DHCP Snooping > Global Parameters** in the tree view to display the **Global Parameters** page.

Figure 19-1. Global Parameters

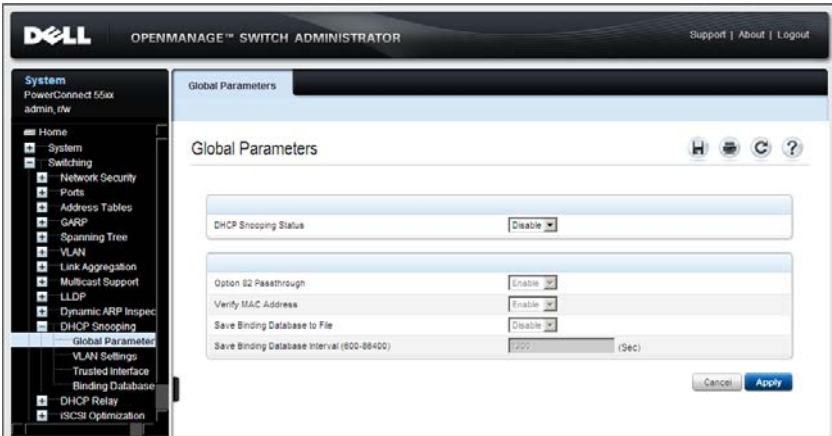

- 2 Enable/disable DHCP snooping on the device in the **DHCP Snooping Status** field.
- 3 If DHCP snooping is enabled, enter the fields:
 - **Option 82 Passthrough** — Enable/disable whether to forward (enable) or filter (disable) DHCP packets, received from untrusted interfaces, with option-82 information.
 - **Verify MAC Address** — Enable/disable MAC addresses verification. This determines whether to forward (enable) or filter (disable) DHCP packets received from untrusted interfaces, whose source MAC address and the DHCP client MAC address do not match.
 - **Save Binding Database to File** — Enable/disable saving the DHCP snooping database to flash memory.
 - **Save Binding Database Internal (600-86400)** — Enter how often, in seconds, the Binding database is updated.

Configuring DHCP Snooping Global Parameters Using CLI Commands

The following table summarizes the CLI commands for configuring DHCP snooping global parameters.

Table 19-2. DHCP Snooping Global Parameters CLI Commands

CLI Command	Description
<code>ip dhcp snooping</code>	Globally enables DHCP snooping.
<code>no ip dhcp snooping</code>	Use the no form of this command to return to the default setting.
<code>ip dhcp snooping information option allowed-untrusted</code>	Allows a device to accept DHCP packets with option-82 information from an untrusted port.
<code>no ip dhcp snooping information option allowed-untrusted</code>	Use the no form of this command to return to the default setting.
<code>ip dhcp snooping verify</code>	Configures the switch to verify on an untrusted port that the source MAC address in a DHCP packet matches the client hardware address.
<code>no ip dhcp snooping verify</code>	Use the no form of this command to configure the switch to not verify the MAC addresses.
<code>ip dhcp snooping database</code>	Configures the DHCP snooping binding file.
<code>no ip dhcp snooping database</code>	Use the no form of this command to delete the binding file.
<code>ip dhcp snooping database update-freq <i>seconds</i></code>	Configures the update frequency of the DHCP snooping binding file.
<code>no ip dhcp snooping database update-freq</code>	Use the no form of this command to return to default.
<code>show ip dhcp snooping</code> [[<i>gigabitethernet</i> <i>tengigabitethernet</i>] <i>port-number</i> <i>port-channel LAG-number</i>]	Displays the DHCP snooping configuration.

The following is an example of some of the CLI commands:

```
console(config)# ip dhcp snooping
console(config)# ip dhcp snooping information option
allowed-untrusted
console(config)# ip dhcp snooping verify
console(config)# ip dhcp snooping database
console(config)# ip dhcp snooping database frequency 1200
console# show ip dhcp snooping
DHCP snooping is enabled
DHCP snooping database: enabled
Option 82 on untrusted port is allowed
Verification of hwaddr field is enabled
DHCP snooping file update frequency is configured to: 1200
seconds
```

Interface	Trusted
gi2/0/1	yes
gi2/0/2	yes

VLAN Settings

To separate ports in a VLAN, enable DHCP snooping on it.

Before you enable DHCP snooping on a VLAN, you must globally enable DHCP snooping on the device.

When DHCP snooping is disabled for a VLAN, the Binding entries that were collected for that VLAN are removed from the Binding database.

To enable/disable DHCP snooping on a VLAN:

- 1 Click **Switching > DHCP Snooping > VLAN Settings** in the tree view to display the **VLAN Settings** page.

Figure 19-2. VLAN Settings

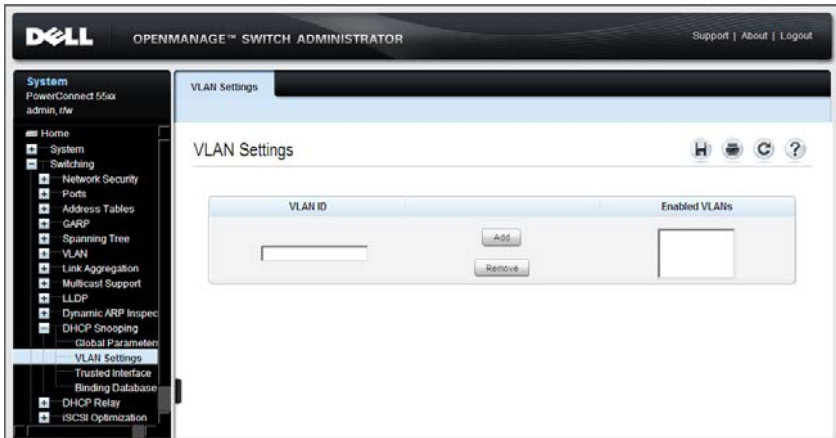

The list of existing VLANs are displayed in the **VLAN ID** list.

- 2 Click **Add** to move the VLANs, for which you want to enable DHCP snooping, from the **VLAN ID** list to the **Enabled VLANs** list. To remove a VLAN, click **Remove** to move it from the **Enabled VLANs** list to the **VLAN ID** list.

Configuring DHCP Snooping on VLANs Using CLI Commands

The following table summarizes the CLI commands for configuring DHCP snooping on VLANs .

Table 19-3. DHCP Snooping on VLANs CLI Commands

CLI Command	Description
<code>ip dhcp snooping vlan <i>vlan-id</i></code>	Enables DHCP snooping on a VLAN.
<code>no ip dhcp snooping <i>vlan-id</i></code>	Use the no form of this command to disable DHCP snooping on a VLAN.

The following is an example of some of the CLI commands:

```
console(config)# ip dhcp snooping vlan 1
```

Trusted Interfaces

To define a trusted interface:

- 1 Click **Switching > DHCP Snooping > Trusted Interface** in the tree view to display the **Trusted Interface: Summary** page.

Figure 19-3. Trusted Interfaces: Summary

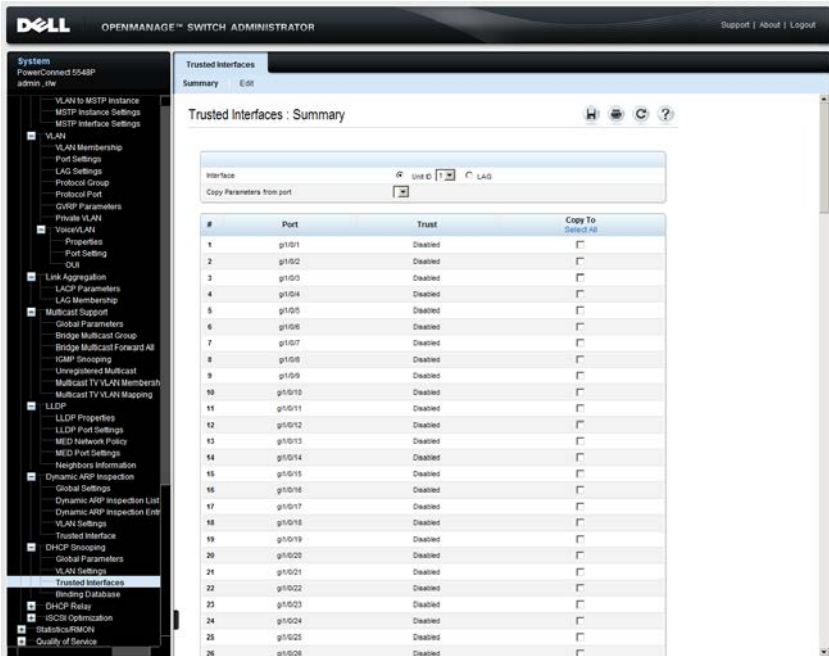

A list of the interfaces is displayed.

- 2 To change the trust status of an interface, click **Edit**, and enter the fields:
 - **Interface** — Select a unit and port or LAG.
 - **Trust Status** — Enable/disable DHCP Snooping Trust mode on the selected port or LAG.

Configuring DHCP Snooping Trusted Interfaces Using CLI Commands

The following table summarizes the CLI commands for configuring DHCP snooping trusted interfaces.

Table 19-4. DHCP Snooping Trusted Interfaces CLI Commands

CLI Command	Description
<code>ip dhcp snooping trust</code>	Configures an interface as trusted for DHCP snooping purposes.
<code>no ip dhcp snooping trust</code>	Use the no form of this command to return to the default setting.

The following is an example of some of the CLI commands:

```
console(config)# interface gil/0/5  
console(config-if)# ip dhcp snooping trust
```

Snooping Binding Database

Entries in the DHCP Snooping Binding database consist of pairs of MAC/IP addresses.

In addition to the entries added by DHCP snooping, entries to the Snooping Binding database can be manually added or deleted. These entries are added to the Snooping Binding database and Snooping Binding file, if it exists, but they are not added to the configuration files.

A manually-added entry can be either dynamic or a static. When configuring a dynamic entry, an expiration date must be assigned.

The refresh time (in seconds) of the binding table is added in the **Global Parameters** pages.

To query and add IP addresses to the Binding database:

- 1 Click **Switching > DHCP Snooping > Binding Database** in the tree view to display the Binding Database: Summary page.

Figure 19-4. Binding Database

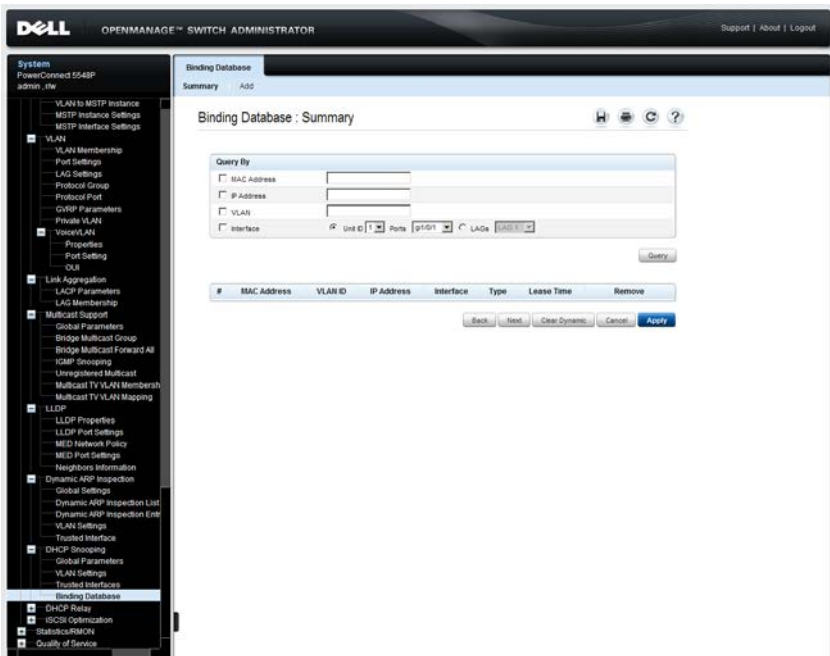

A list of the database entries is displayed.

- 2 To query the database, enter query criteria and click **Query**. Database entries matching the query are displayed.
- 3 To add a entry, click **Add**, and enter the fields:
 - **Type** — Select the entry type. The possible options are:
 - **Static** —IP address was statically configured.
 - **Dynamic** —IP address was dynamically configured.
 - **MAC Address** — Enter the MAC address to be recorded in the entry.

- **VLAN ID** — Select the VLAN ID to which the IP address is associated in the entry.
- **IP Address** — Enter the IP address to be recorded in the entry.
- **Interface** — Select the unit and port or LAG to be recorded in the entry.
- **Lease Time** — If the entry is dynamic, enter the amount of time that the entry will be active in the DHCP Database. If there is no Lease Time, check **Infinite**.

Configuring DHCP Snooping Binding Database Using CLI Commands

The following table summarizes the CLI commands for configuring the DHCP Snooping Binding database.

Table 19-5. DHCP Snooping Binding Database CLI Commands

CLI Command	Description
<code>ip dhcp snooping database</code>	Enables the DHCP Snooping binding database file.
<code>no ip dhcp snooping database</code>	Use the no form of this command to delete the DHCP Snooping binding database file.
<code>ip dhcp snooping database update-freq <i>seconds</i></code>	Enables the DHCP Snooping binding database file.
<code>no ip dhcp snooping database update-freq</code>	Use the no form of this command to delete the DHCP Snooping binding database file.
<code>ip dhcp snooping binding <i>mac-address vlan-id ip-address</i> [<i>gigabitethernet tengigabitethernet</i>] <i>port-number</i> port-channel <i>LAG-number</i>] expiry {<i>seconds</i> infinite}</code>	Configures the DHCP snooping binding database and adds binding entries to the database.
<code>no ip dhcp snooping binding <i>mac-address vlan-id</i></code>	Use the no form of this command to delete entries from the binding database.
<code>clear ip dhcp snooping database</code>	Clears the DHCP binding database.

Table 19-5. DHCP Snooping Binding Database CLI Commands (Continued)

CLI Command	Description
show ip dhcp snooping binding [mac-address <i>mac-address</i>] [ip-address <i>ip-address</i>] [vlan <i>vlan-id</i>][[gigabitethernet tengigabitethernet] <i>port-number</i> port-channel <i>LAG-number</i>]]	Displays the DHCP snooping binding database and configuration information for all interfaces or some interfaces on a switch.

The following is an example of some of the CLI commands:

console(config)# ip dhcp snooping database					
console(config)# ip dhcp snooping update-freq 3600					
console# show ip dhcp snooping binding					
Update frequency: 3600					
Total number of binding: 2					
MAC Address	IP Address	Lease (sec)	Type	VLAN	Interface
-----	-----	-----	-----	-----	-----
0060.704C.73FF	10.1.8.1	7983	snooping	3	gil/0/21
0060.704C.7BC1	10.1.8.2	92332	snooping	(s)3	gil/0/22

DHCP Relay

This section describes DHCP relay.

It contains the following topics:

- DHCP Relay Overview
- Option 82
- Global Settings
- Interface Settings

DHCP Relay Overview

The device can act as a DHCP Relay agent that listens for DHCP messages, and relays them between DHCP servers and clients, which reside in different VLANs or IP subnets.

This functionality is intended to be used when the client ingress VLAN is different than the VLAN on which DHCP servers are connected.

The switch can relay DHCP messages received from its IPv4 interfaces to one or more configured DHCP servers. The switch puts the IPv4 address into the message giaddr before relaying it to the servers. It uses the switch's IPv4 address of the interface where the message is received. The switch uses the giaddr from the response to determine how to forward the response back to the DHCP client.

DHCP Relay must be enabled globally and per VLAN.

Option 82 Overview

The relay agent information option (Option 82) in the DHCP protocol enables a DHCP relay agent to send additional client information when requesting an IP address. Option 82 specifies the relaying switch's MAC address, the port identifier, and the VLAN that forwarded the packet.

Both DHCP snooping and DHCP relay can insert option 82 into traversing packets.

DHCP snooping with option 82 insertion provides transparent Layer 2 relay agent functionality when the DHCP server is on the same VLAN as the clients.

Limitations

The following limitations exist for DHCP Relay:

- It is not supported on IPv6.
- It is not relayed to servers on the client's VLAN.
- Packets that have option-82 information, added by other devices, are discarded.
- It does not support Option 82 on non-VLAN interfaces.
- It can be enabled only on a VLAN/Port/LAG that has an IP address defined on it.

Option 82

To enable Option82 insertion:

- 1 Click Switching > DHCP Relay > Option 82 in the tree view to display the Option 82 page.

Figure 19-5. Option 82

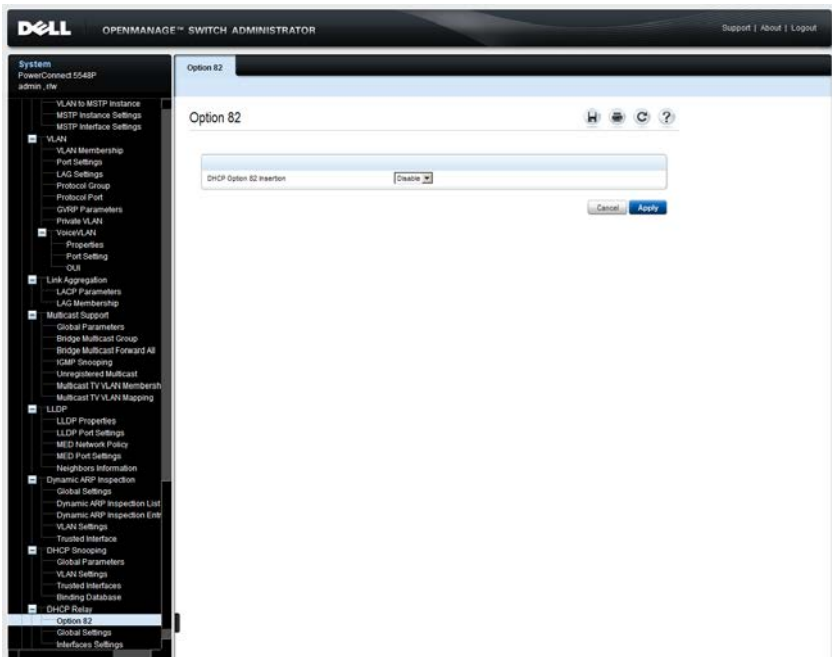

- 2 Enable/disable Option 82 insertion.

Configuring Option 82 Using CLI Commands

The following table summarizes the CLI commands for defining fields displayed in the Option 82 page.

Table 19-6. CLI Option 82 Commands

CLI Command	Description
<code>ip dhcp information option</code>	Enables DHCP option-82 data insertion.
<code>no ip dhcp information option</code>	Use the no form of this command to disable DHCP option-82 data insertion.

The following is an example of the CLI command:

```
console(config)# ip dhcp information option
```

Global Settings

To set the DHCP Relay global settings:

- 1 Click **Switching > DHCP Relay > Global Settings** in the tree view to display the **Global Settings: Summary** page.

Figure 19-6. Global Settings: Summary

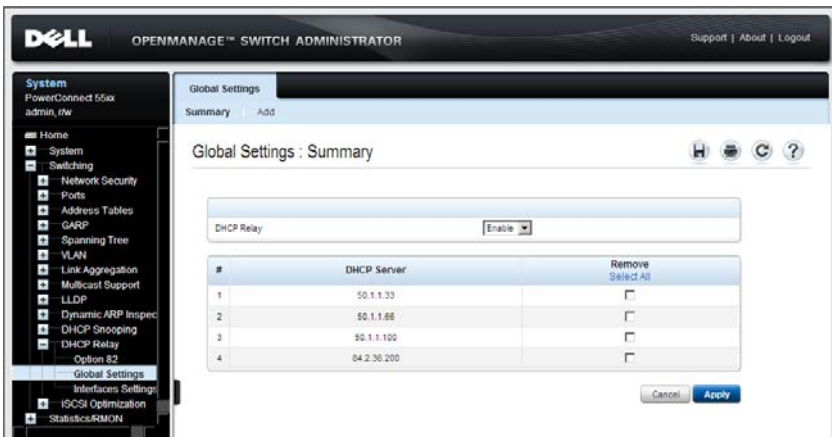

The currently-define DHCP servers are displayed.

- 2 Enable/disable DHCP relay.

- 3 To add a DHCP server, click **Add**.
- 4 Enter the IP address of the DHCP server in the **DHCP Server IP Address** field.

Defining Global Parameters Using CLI Commands

The following table summarizes the CLI commands for defining fields displayed in the **Global Settings** pages.

Table 19-7. Global Parameters CLI Commands

CLI Command	Description
ip dhcp relay enable	Enables DHCP relay features on the device.
no ip dhcp relay enable	Use the no form of this command to disable the DHCP relay agent.
ip dhcp relay address <i>ip-address</i>	Defines the DHCP servers available for the DHCP relay.
no ip dhcp relay address [<i>ip-address</i>]	Use the no form of this command to remove servers from the list.
show ip dhcp relay	Displays the server addresses on the DHCP relay.

The following is an example of the CLI commands:

```

console(config-if)# ip dhcp relay enable
console(config)# ip dhcp relay address 176.16.1.1
console(config)# do show ip dhcp relay
DHCP relay is Enabled
Option 82 is Disabled
Maximum number of supported VLANs without IP Address is 0
DHCP relay is not configured on any port.
DHCP relay is not configured on any VLAN.
Servers: 176.16.1.1
console(config)#

```

Interface Settings

-  **NOTE:** For DHCP Relay to function on an interface, it also must be activated globally in the **Global Settings** page.

To enable DHCP relay on a port, LAG, or VLAN:

- 1 Click Switching > DHCP Relay > Interface Settings in the tree view to display the **Interface Settings: Summary** page.

Figure 19-7. Interface Settings: Summary

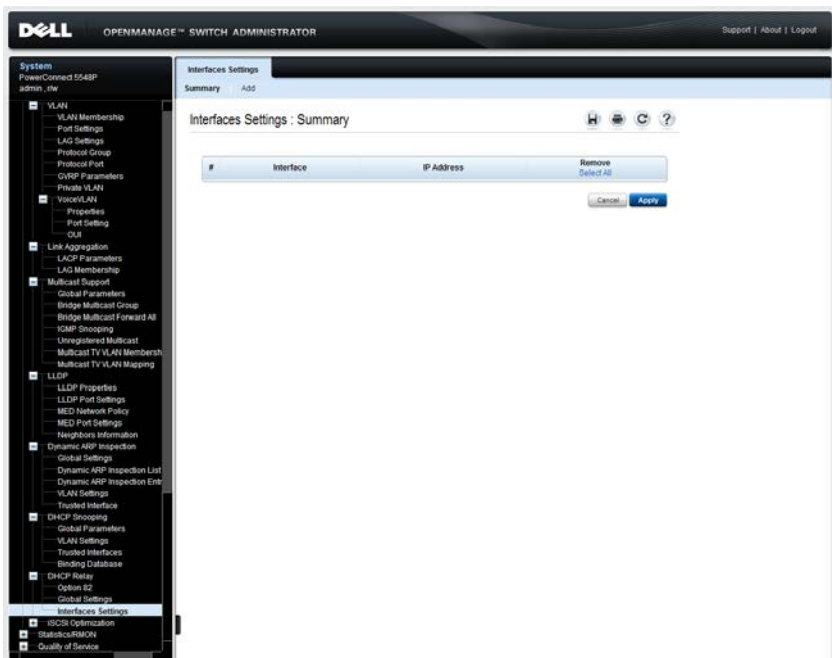

The currently-define DHCP interfaces are displayed.

- 2 To enable DHCP relay on an interface, click **Add**.
- 3 Select the interface.

Defining Interface Settings Using CLI Commands

The following table summarizes the CLI commands for defining fields displayed in the **Interface Settings** pages.

Interface Settings Parameters CLI Commands

CLI Command	Description
ip dhcp relay enable	Enables the DHCP relay features on the interface (in Interface Configuration mode).
no ip dhcp relay enable	
ip dhcp relay address ip-address	Defines a DHCP servers available for DHCP relay.
no ip dhcp relay address	Use the no form of this command to remove servers from the list.

The following is an example of the CLI commands that enable DHCP Relay on VLAN 2, assign it an IP address and show the DHCP Relay status:

```
console(config)# interface vlan 2
console(config-if)# ip dhcp relay enable
console(config)# ip dhcp relay address 176.16.1.1
console> show ip dhcp relay
DHCP relay is Enabled
Option 82 is Disabled
Maximum number of supported VLANs without IP Address is 0
DHCP relay is not configured on any port.
DHCP relay is not configured on any vlan.
No servers configured
```

20

iSCSI Optimization

This section describes iSCSI optimization.

It contains the following topics:

- Optimizing iSCSI Overview
- Global Parameters
- iSCSI Targets
- iSCSI Sessions
- Configuring iSCSI Using CLI

Optimizing iSCSI Overview

The Internet Small Computer System Interface (iSCSI) is an IP-based storage networking standard for linking data storage facilities. By carrying SCSI commands over IP networks, iSCSI is used to facilitate data transfers over intranets, and to manage storage over long distances.

iSCSI can be used to transmit data over local area networks (LANs), wide area networks (WANs), or the Internet, and can enable location-independent data storage and retrieval.

Unlike traditional Fiber channels, which requires special-purpose cabling, iSCSI can be run over long distances, using existing network infrastructure.

The protocol enables clients (called initiators) to send SCSI commands (CDBs) to SCSI storage devices (targets) on remote servers. This enables organizations to consolidate storage into data center storage arrays, while providing hosts (such as database and web servers) with the illusion of locally-attached disks.

The targets listen on a well-known TCP port (or any other TCP port that has been explicitly specified) for incoming connections. The login process is started when the initiator establishes a TCP connection to the desired target, through the TCP port that was explicitly specified.

The group of iSCSI TCP connections that link an initiator with a target is called an iSCSI session.

When you connect an EqualLogic device to the switch, and iSCSI optimization is enabled, the switch automatically recognizes the port to which the EqualLogic equipment is connected to, and configures the STP Mode to RSTP to support fast network convergence.

Optimizing iSCSI

iSCSI optimization provides the following features:

- Ability to assign a specific QoS profile to the iSCSI flows
- Display of iSCSI session details (connections, initiator, target, and so on)
- Identification of (self-discovered) iSCSI sessions
- Identification of iSCSI session termination
- Identification of non-active iSCSI sessions

Limitations

The following limitations exist:

- All iSCSI connections receive the relevant QoS, regardless of whether they are being monitored or not. If, for example, a feature was disabled for some period and was enabled again, it is possible that there are iSCSI TCP connections that were established during this period of time. These cannot be monitored, because all relevant information was already passed at the beginning of the session. But these unidentified sessions will still be assigned to iSCSI QoS.
- The maximum number of iSCSI TCP connections, which is also the default setting, is 1K. This can be changed after reset.
- The number of iSCSI connections affects other system features. iSCSI-aware, DHCP Snooping, and ACL rules all use the TCAM system resource. If the number of iSCSI connections has been increased, the other application rules (DHCP Snooping or ACL) can be removed after reset.
- If the target uses redirect messages upon the initiator request, and, as a result, the initiator opens a connection to a different target, the new target must be configured as part of the general configuration.
- Only iSCSI flows to targets that use the iSCSI well-known port or other explicit user-defined configuration are assigned QoS.
- The aging configuration works for each connection. The mechanism checks connection activities in a group of 28 TCP iSCSI connections, within the aging time. In the worst case, when the maximum number of 1K TCP connections are monitored and are not terminated gracefully, the mechanism causes inaccuracy, namely, the last 28 TCP iSCSI connections are aged out after $(1K/28) * \text{aging-time}$.
- In general, the greater the number of ungracefully terminated iSCSI TCP connections, the greater the inaccuracy is. Not all iSCSI TCP connections are monitored for aging at the same time. Sessions, whose associated TCP connections are not being currently monitored, will show unchanged aging time.
- Encryption (Ipsec) must not be applied on iSCSI traffic, otherwise a QoS profile will not be assigned to iSCSI.
- iSCSI optimization does not work with IP fragmented frames.

- Each session supports at most four TCP connections. If a new TCP connection of an already opened iSCSI session arrives, and there are already four TCP connections, the new connection replaces the oldest one, within this specific iSCSI session.
- A short flow interruption, caused by STP topology change or administrative port-down action, might cause the TCP connection to reinitiate without closing the iSCSI session. If the actual iSCSI session used only one TCP connection, the reinitiated one will be added to the monitoring table, for an aging-time period. After that, it is removed from the list.

Global Parameters

Use the **Global Parameters** page to enable iSCSI and to set iSCSI QoS frame priority. You may also enable **Remark** to change the DSCP or CoS user priority field in the packet. In the **QoS Properties** pages, you can then set the queuing to *strict priority* or *WRR*, and map the CoS or DSCP to the desired queue in the **CoS to Queue** or **DSCP to Queue** pages.

To enable iSCSI and set its QoS parameters:

- 1 Click **System > iSCSI Optimization > Global Parameters** in the tree view to display the **Global Parameters** page.

Figure 20-1. Global Parameters

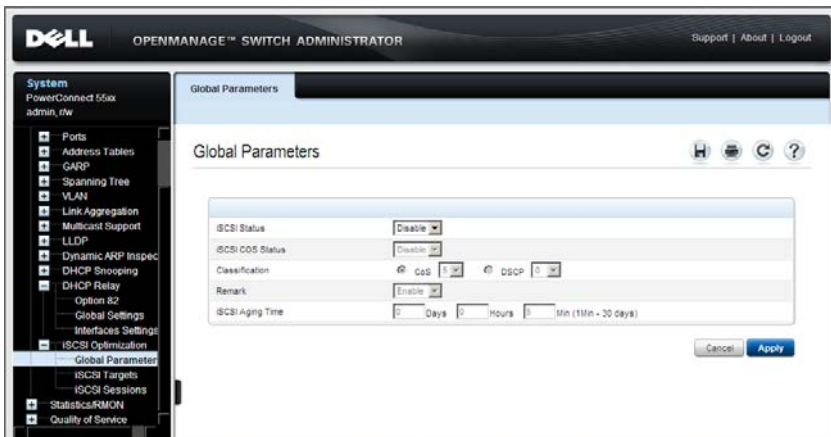

- 2 Enter the fields:
 - **iSCSI Status** — Enable/disable iSCSI optimization.
 - **iSCSI COS Status** — Enable/disable the Class of Service profile to apply to iSCSI flows.
 - **Classification** — Select whether the priority of iSCSI packets is determined by CoS or DSCP. Check the classification, and select the desired value.
 - **Remark** — Enable/disable whether iSCSI frames will be remarked with the CoS or DSCP value.

- **iSCSI Aging Time** — Enter how long the device will wait, after the last received frame of an iSCSI session, before deleting the session from the list.

Enabling iSCSI automatically enables Jumbo frames and enables Flow Control on all interfaces. Jumbo frames are only enabled after copying the Running configuration to the Startup configuration and resetting the device (the Flow Control changes are effective immediately).

Defining iSCSI Global Parameters Using CLI Commands

The following table summarizes the CLI commands for defining fields displayed in the **iSCSI Global Parameters** pages.

Table 20-1. iSCSI Global Parameters CLI Commands

CLI Command	Description
iscsi enable	Enables iSCSI awareness.
no iscsi enable	Use the no form of the command to disable iSCSI awareness.
iscsi cos { <i>vpt vpt</i> <i>dscp dscp</i> } [<i>remark</i>]	Sets the quality of service profile that will be applied to iSCSI flows.
no iscsi cos	Use the no form of the command to return to default.
iscsi aging time <i>minutes</i>	Sets the aging time for iSCSI sessions.
no iscsi aging time	Use the no form of the command to cancel aging.
show iscsi	Displays iSCSI settings.

The following is an example of the CLI commands:

```
console(config)# iscsi enable
console(config)# iscsi cos dscp 31
console(config)# iscsi aging time 10
console# show iscsi
Target: iqn.1993-11.com.disk-vendor:diskarrays.sn.45678
-----
Session 1:
-----
Initiator: iqn.1992-04.com.os-vendor.plan9:cdrom.12.
storage:sys1.xyz
Time started: 23-Jul-2002 10:04:50
Time for aging out: 10 min
ISID: 11

Initiator      Initiator      Target          Target
IP Address    TCP Port       IP Address      IP port
-----
172.16.1.3    49154          172.16.1.20    30001
```

iSCSI Targets

To add an iSCSI target:

- 1 Click **System > iSCSI Optimization > iSCSI Targets** in the tree view to display the **iSCSI Targets: Summary** page.

Figure 20-2. iSCSI Targets: Summary

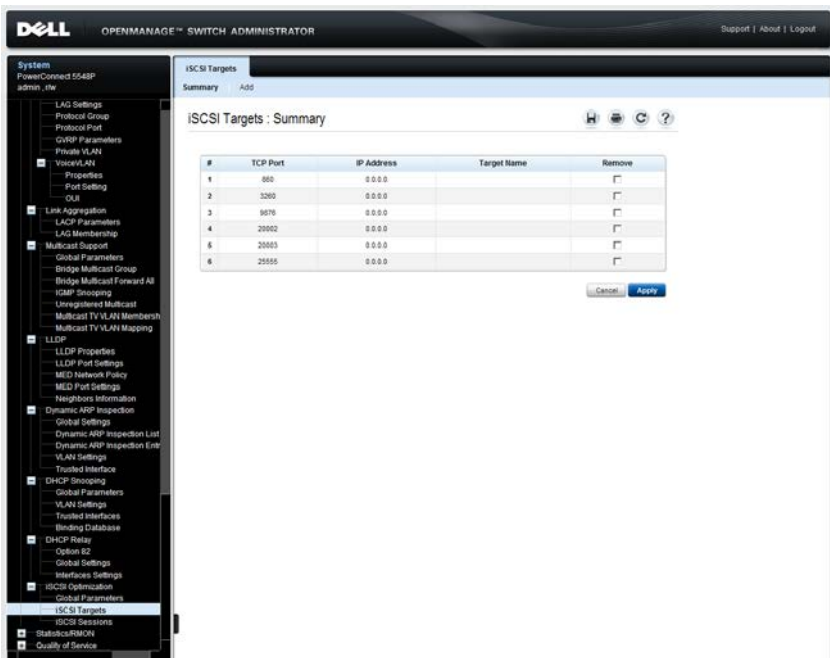

The currently-defined targets are displayed.

- 2 To add a new target, click **Add**.
- 3 Enter the fields:
 - **TCP Port** — TCP port used by the target for iSCSI communications.
 - **IP Address** — IP address of the target. The IP address 0.0.0.0 is *any* IP address.
 - **Target Name (0-223 characters)** — Name of the target.

Defining iSCSI Targets Using CLI Commands

The following table summarizes the CLI commands for defining fields displayed in the iSCSI Targets Table.

Table 20-2. iSCSI Targets Table CLI Commands

CLI Command	Description
<code>iscsi target port tcp-port-1 [tcp-port-2... tcp-port-8] [address ip-address] [name target-name]</code>	Configures iSCSI port/s, target address and name. Use the no form of this command to delete an iSCSI target.
<code>no iscsi target port tcp-port-1 [tcp-port-2... tcp-port-8] [address ip-address]</code>	
<code>show iscsi sessions</code>	Show the current iSCSI targets and sessions.

The following is an example of the CLI commands:

```
console(config)# iscsi target port 30001 address
176.16.1.1 name iqn.1993-11.com.disk
vendor:diskarrays.sn.45678.tape:sys1.xyz
```

iSCSI Sessions

To display information about iSCSI communications to various targets:

- 1 Click **System > iSCSI Optimization > iSCSI Sessions** in the tree view to display the iSCSI Sessions page.

Figure 20-3. iSCSI Sessions

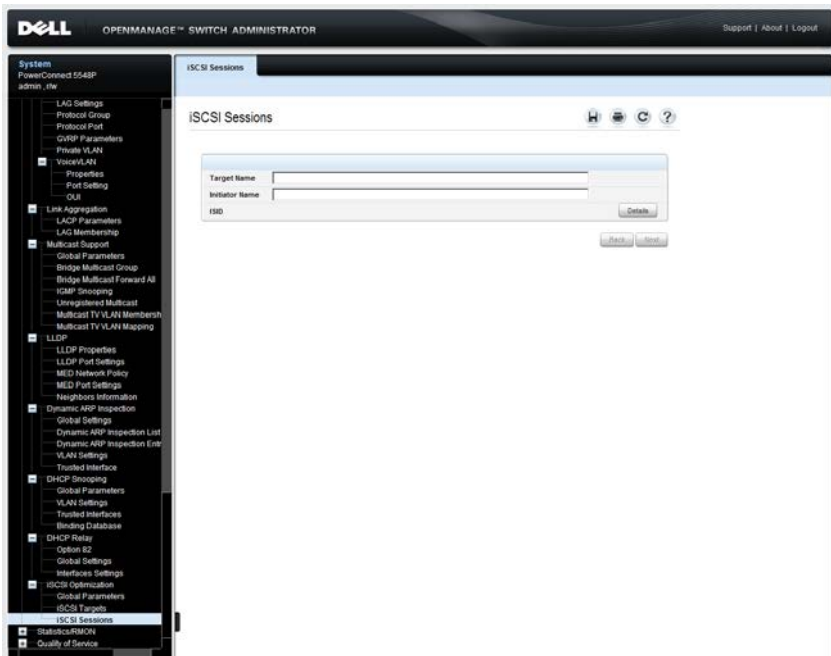

- 2 Select a target and click **Details**. The following is displayed:
 - **Target Name** — The name of the target.
 - **Initiator Name** — The name of the initiator.
 - **ISID** — The iSCSI session ID.
 - **Session Life Time** — The amount of time that has passed since the first frame of the session.
 - **Aging Time** — The time left until the session ages out and is removed.

- **Initiators/Targets** — The IP address and TCP port used by each initiator and target in the session is displayed.

Displaying iSCSI Sessions Using CLI Commands

The following table summarizes the CLI commands for displaying iSCSI sessions.

Table 20-3. iSCSI CLI Commands

CLI Command	Description
show iscsi sessions [<i>detailed</i>]	Displays iSCSI sessions

The following is an example of the CLI commands:

```

console(config)# show iscsi sessions
Target: iqn.1993-11.com.disk-vendor:diskarrays.sn.45678
-----
Initiator: iqn.1992-04.com.os-vendor.plan9:cdrom.12
ISID: 11
Initiator: iqn.1995-05.com.os-vendor.plan9:cdrom.10
ISID: 222
-----
Target: iqn.103-1.com.storage-vendor:sn.43338.storage.tape:sys1.xyz
-----
Initiator: iqn.1992-04.com.os-vendor.plan9:cdrom.12
ISID: 44
Initiator: iqn.1995-05.com.os-vendor.plan9:cdrom.10
ISID: 65
-----
console# show iscsi sessions detailed
Target: iqn.1993-11.com.disk-vendor:diskarrays.sn.45678
-----
Session 1:
-----
Initiator: iqn.1992-04.com.os-vendor.plan9:cdrom.12.storage:sys1.xyz
UP Time: 02:10:45 (DD:HH:MM)
Time for aging out: 10 min
ISID: 11
Initiator IP Address   Initiator TCP Port   Target IP Address   Target IP Port
-----
172.16.1.3             49154                172.16.1.20        3001
172.16.1.3             49154                172.16.1.20        3001
1172.16.1.3            49154                172.16.1.20        3001
30001Initiator: iqn.1995-05.com.os-vendor.plan9:cdrom.10
Status: Active
UP Time: 00:04:50 (DD:HH:MM)
Time for aging out: 2 min
ISID: 22

```

Configuring iSCSI Using CLI

The following is a sample procedure to configure the iSCSI feature using CLI:

Table 20-4. Sample CLI Script to Configure iSCSI

CLI Command	Description
<code>iscsi enable</code>	Enable iSCSI.
<code>iscsi cos vpt 2 remark</code>	Set iSCSI flow to use VPT 2 (Layer 2 CoS). This VPT value replaces the original VPT in the packet.
<code>show iscsi sessions</code>	Verify that iSCSI is enabled and that the iSCSI flows are displayed.

Statistics/RMON

This section describes many of the statistics available on the device. The only exception is the QoS statistics described in "Quality of Service" on page 640.

It contains the following topics:

- Table Views
- RMON Components
- Charts

Table Views

This section displays statistics in table form.

It contains the following topics:

- Denied ACEs Counters
- Utilization Summary
- Counter Summary
- Interface Statistics
- Etherlike Statistics
- GVRP Statistics
- EAP Statistics

Denied ACEs Counters

The Denied ACEs counters contain the number of packets that were dropped (denied) because they did not meet ACL criteria expressed in some ACE.

To display the denied ACE counters:

- 1 Click **Statistics/RMON > Table Views > Denied ACEs Counters** in the tree view to display the **Denied ACEs Counters** page.

Figure 21-1. Denied ACEs Counters

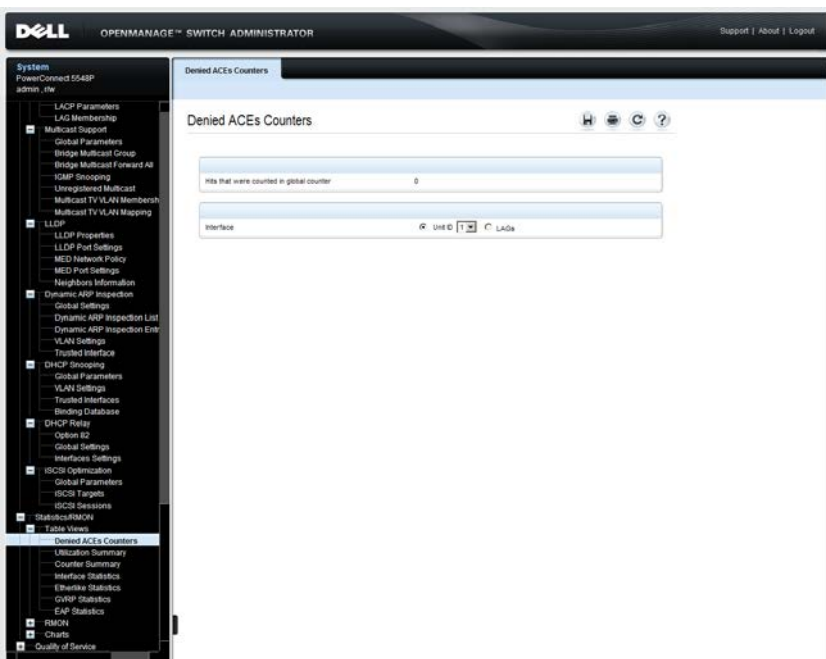

The global number of dropped packets is displayed along with the number of dropped packets on each interface.

- 2 To clear the counters, select either a stack unit and port or LAG. All ports/LAGs in the unit are displayed.
- 3 Mark the counters to be cleared and click **Clear Counters**.
- 4 To clear all counters, click **Clear All Counters**.

Viewing Denied ACE Counters Statistics Using the CLI Commands

The following table contains the CLI commands for viewing denied ACE counters statistics.

Table 21-1. Denied ACE Counters CLI Commands

CLI Command	Description
show interfaces access-lists counters [<i>gigabitethernet</i> <i>tengigabitethernet</i>] <i>port-number</i> <i>port-channel LAG-number</i>]	Displays Access List counters.

The following is an example of the CLI commands:

```
console# show interfaces access-lists counters
Interface Denied ACE hits
-----
gil/0/1          55
gil/0/2          33
gil/0/3          32
```

Utilization Summary

Use the **Utilization Summary** page to display interface utilization. This page is refreshed periodically to minimize impact on performance. Display may be disrupted during this period.

To display interface utilization statistics:

- 1 Click **Statistics/RMON > Table Views > Utilization Summary** in the tree view to display the **Utilization Summary** page.

Figure 21-2. Utilization Summary

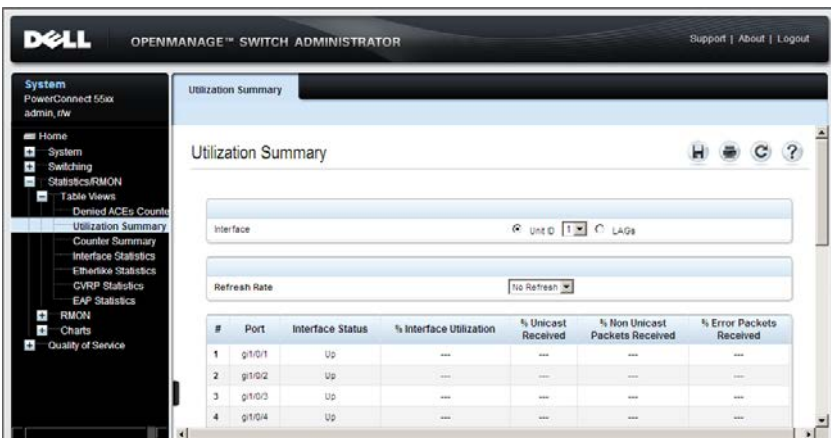

- 2 Select a unit and port/LAG.

The following fields are displayed:

- **Port/LAG** — The port/LAG number.
- **Interface Status** — The status of the interface: **Up**, **Down** or **Not Present** when no port is attached to the LAG.
- **% Interface Utilization** — Network interface utilization percentage, based on the duplex mode of the interface. The range of this reading is from 0 to 200%. The maximum reading of 200% for a full duplex connection indicates that 100% of bandwidth of incoming and outgoing connections is used by the traffic travelling through the interface. The maximum reading for a half duplex connection is 100%.

- **% Unicast Received** — Percentage of Unicast packets received on the interface.
 - **% Non Unicast Packets Received** — Percentage of non-Unicast packets received on the interface.
 - **% Error Packets Received** — Percentage of packets with errors received on the interface.
- 3** Select one of the **Refresh Rate** options to specify how frequently the statistics should be refreshed.
- The CPU utilization chart is displayed.

Counter Summary

To display the number of received and transmitted packets on ports, as numeric figures and not percentages:

- 1 Click **Statistics/RMON > Table Views > Counter Summary** in the tree view to display the **Counter Summary** page.

Figure 21-3. Counter Summary

#	Port	Interface Status	Received Unicast Packets	Transmitted Unicast Packets	Received Non Unicast Packets	Transmitted Non Unicast Packets	Received Errors
1	g1/0/1	Down	0	0	0	0	0
2	g1/0/2	Down	0	0	0	0	0
3	g1/0/3	Down	0	0	0	0	0
4	g1/0/4	Down	0	0	0	0	0
5	g1/0/5	Down	0	0	0	0	0
6	g1/0/6	Down	0	0	0	0	0
7	g1/0/7	Down	0	0	0	0	0
8	g1/0/8	Down	0	0	0	0	0
9	g1/0/9	Down	0	0	0	0	0
10	g1/0/10	Down	0	0	0	0	0
11	g1/0/11	Down	0	0	0	0	0
12	g1/0/12	Down	0	0	0	0	0
13	g1/0/13	Down	0	0	0	0	0
14	g1/0/14	Down	0	0	0	0	0
15	g1/0/15	Down	0	0	0	0	0
16	g1/0/16	Down	0	0	0	0	0
17	g1/0/17	Down	0	0	0	0	0
18	g1/0/18	Down	0	0	0	0	0
19	g1/0/19	Down	0	0	0	0	0
20	g1/0/20	Down	0	0	0	0	0
21	g1/0/21	Down	0	0	0	0	0
22	g1/0/22	Down	0	0	0	0	0
23	g1/0/23	Down	0	0	0	0	0
24	g1/0/24	Down	0	0	0	0	0

Counters for the selected units or LAG are displayed.

- 2 Select a port/LAG.

The following fields are displayed:

- **Port/LAG** — The interface number.
- **Interface Status** — Status of the interface: **Up** or **Down**.
- **Received Unicast Packets** — Number of received Unicast packets on the interface.

- **Transmitted Unicast Packets** — Number of transmitted Unicast packets from the interface.
 - **Received Non Unicast Packets** — Number of received non-Unicast packets on the interface.
 - **Transmitted Non Unicast Packets** — Number of transmitted non-Unicast packets from the interface.
 - **Received Errors** — Number of received packets with errors on the interface.
- 3** Select one of the **Refresh Rate** options to specify how frequently the counters should be refreshed.

Interface Statistics

To display the number of received and transmitted packets on an interface:

- 1 Click **Statistics/RMON > Table Views > Interface Statistics** in the tree view to display the **Interface Statistics** page.

Figure 21-4. Interface Statistics

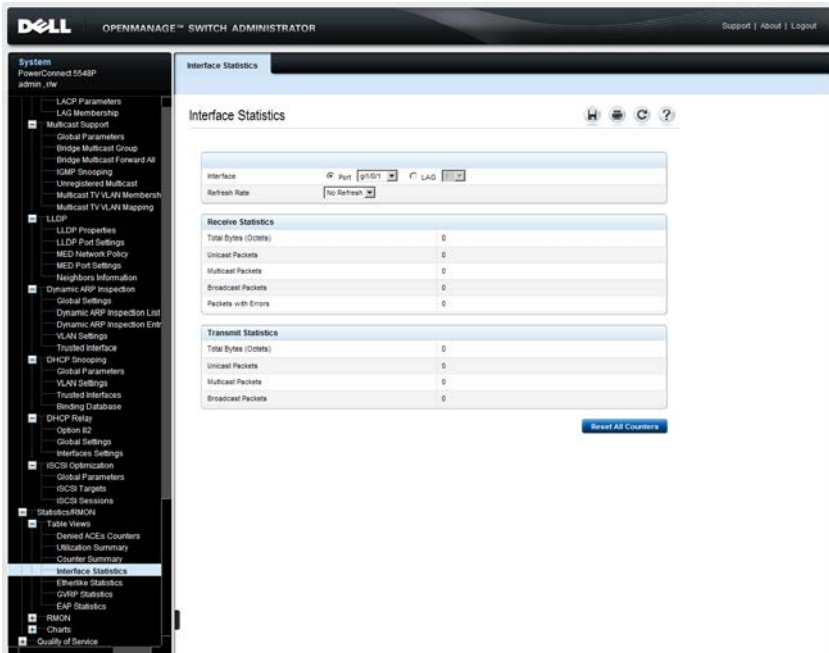

- 2 Select a port/LAG.
- 3 Select one of the **Refresh Rate** options to specify how frequently the counters should be refreshed.

The following fields are displayed:

Receive Statistics

- **Total Bytes (Octets)** — Amount of octets received on the selected interface.

- **Unicast Packets** — Number of Unicast packets received on the selected interface.
- **Multicast Packets** — Number of Multicast packets received on the selected interface.
- **Broadcast Packets** — Number of Broadcast packets received on the selected interface.
- **Packets with Errors** — Number of errors packets received on the selected interface.

Transmit Statistics

- **Total Bytes (Octets)** — Number of octets transmitted from the selected interface.
- **Unicast Packets** — Number of Unicast packets transmitted from the selected interface.
- **Multicast Packets** — Number of Multicast packets transmitted from the selected interface.
- **Broadcast Packets** — Number of Broadcast packets transmitted from the selected interface.

- 4** Click **Reset All Counters** to clear these counters.

Etherlike Statistics

To display interface error statistics:

- 1 Click **Statistics/RMON > Table Views > Etherlike Statistics** in the tree view to display the **Etherlike Statistics** page.

Figure 21-5. Etherlike Statistics

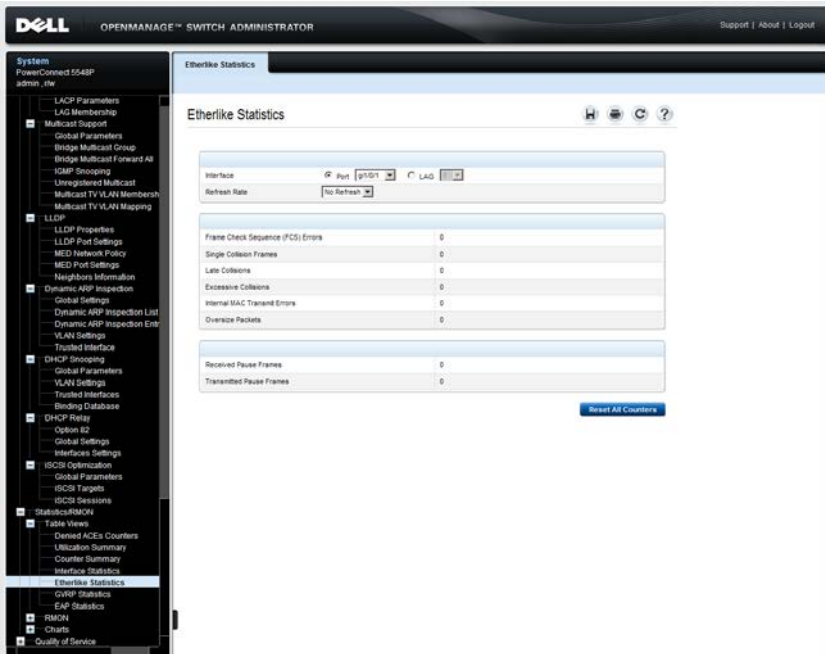

- 2 Select a port/LAG.

The following fields are displayed:

- **Frame Check Sequence (FCS) Errors** — Number of frames received that are an integral number of octets in length but do not pass the FCS check.
- **Single Collision Frames** — Number of frames that are involved in a single collision, and are subsequently transmitted successfully.
- **Late Collisions** — Number of collisions detected after the first 512 bits of data.

- **Excessive Collisions** — Number of frames for which transmission fails due to excessive collisions.
 - **Internal MAC Transmit Errors** — Number of frames for which reception fails due to an internal MAC sublayer receive error.
 - **Oversize Packets** — Number of frames received that exceed the maximum permitted frame size.
 - **Received Pause Frames** — Number of MAC Control frames received with a PAUSE operation code.
 - **Transmitted Pause Frames** — Number of MAC Control frames transmitted on this interface with a PAUSE operation code.
- 3** Select one of the **Refresh Rate** options to clear the statistics for the selected interface.

Viewing Interface Statistics Using the CLI Commands

The following table contains the CLI commands for viewing utilization, counters and interface statistics.

Table 21-2. Interface Statistics CLI Commands

CLI Command	Description
<code>show interfaces counters</code> [[<i>gigabitethernet</i> <i>tengigabitethernet</i>] <i>port-number</i> <i>port-channel</i> <i>LAG-number</i>]	Displays traffic seen by the physical interface.

The following is an example of the CLI command for all ports:

```

console# show interfaces counters
Port      InUcastPkts InMcastPkts InBcastPkts InOctets
-----
gi2/0/1  0           0           0           0
gi2/0/2  0           0           0           0
gi2/0/3  0           0           0           0
gi2/0/4  0           0           0           0
gi2/0/5  0           0           0           0
Port      OutUcastPkts OutMcastPkts OutBcastPkts OutOctets
-----
gi2/0/1  0           0           0           0
gi2/0/2  0           0           0           0
gi2/0/3  0           0           0           0
gi2/0/4  0           0           0           0

```

The following is an example of the CLI command for a single port:

```

console# show interfaces counters gil/0/1
Port      InUcastPkts InMcastPkts InBcastPkts InOctets
-----
gil/0/1  0           0           0           0

Port      OutUcastPkts OutMcastPkts OutBcastPkts OutOctets
-----
gil/0/1  0           0           0           0

Alignment Errors: 0
FCS Errors: 0
Single Collision Frames: 0
Multiple Collision Frames: 0
SQE Test Errors: 0
Deferred Transmissions: 0
Late Collisions: 0
Excessive Collisions: 0
Carrier Sense Errors: 0
Oversize Packets: 0
Internal MAC Rx Errors: 0
Symbol Errors: 0
Received Pause Frames: 0

```

GVRP Statistics

To display device GVRP statistics:

- 1 Click **Statistics/RMON > Table Views > GVRP Statistics** in the tree view to display the **GVRP Statistics** page.

Figure 21-6. GVRP Statistics

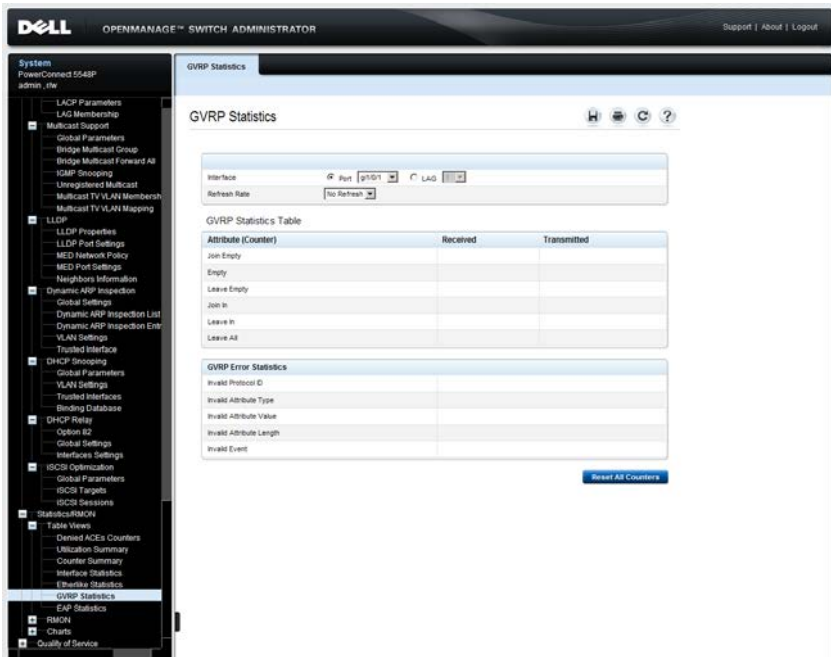

- 2 Select a port/LAG.

The number of received and transmitted packets in the following counters is displayed:

GVRP Statistics Table

- **Join Empty** — The number of GVRP Join Empty packets.
- **Empty** — The number of GVRP empty packets.
- **Leave Empty** — The number of GVRP Leave Empty packets.
- **Join In** — The number of GVRP Join In packets.

- **Leave In** — The number of GVRP Leave In packets.
- **Leave All** — The number of GVRP Leave All packets.

GVRP Error Statistics

- **Invalid Protocol ID** — The number of GVRP Invalid Protocol ID errors.
 - **Invalid Attribute Type** — The number of GVRP Invalid Attribute ID errors.
 - **Invalid Attribute Value** — The number of GVRP Invalid Attribute Value errors.
 - **Invalid Attribute Length** — The number of GVRP Invalid Attribute Length errors.
 - **Invalid Event** — The number of GVRP Invalid Events errors.
- 3** Select one of the **Refresh Rate** options to specify how frequently the statistics should be refreshed.

Viewing GVRP Statistics Using the CLI Commands

The following table contains the CLI commands for viewing GVRP statistics.

Table 21-3. GVRP Statistics CLI Commands

CLI Command	Description
<code>show gvrp statistics</code> <code>[[gigabitethernet tengigabitethernet</code> <code>] interface/port-channel LAG-number]</code>	Displays GVRP statistics.
<code>show gvrp error-statistics</code> <code>[[gigabitethernet tengigabitethernet</code> <code>] interface/port-channel LAG-number]</code>	Displays GVRP error statistics.

The following is an example of the CLI commands:

```
console# show gvrp statistics
GVRP Statistics:
-----
Legend:
  rJE  : Join Empty Received      rJIn: Join In Received
  rEmp : Empty Received           rLIn: Leave In Received
  rLE  : Leave Empty Received     rLA : Leave All Received
  sJE  : Join Empty Sent          sJIn: Join In Sent
  sEmp : Empty Sent              sLIn: Leave In Sent
  sLE  : Leave Empty Sent         sLA : Leave All Sent
Port   rJE  rJIn rEmp  rLIn  rLE  rLA  sJE  sJIn sEmp  sLIn  sLE  sLA
-----
```

EAP Statistics

For information about EAP, see "Dot1x Authentication" on page 127.

To display EAP statistics:

- 1 Click **Statistics/RMON > Table Views > EAP Statistics** in the tree view to display the **EAP Statistics** page.

Figure 21-7. EAP Statistics

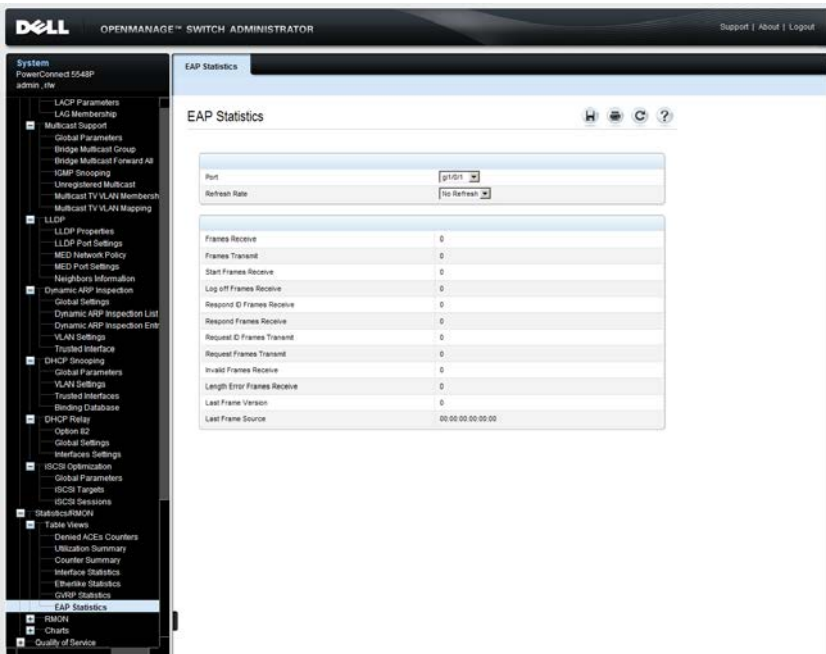

- 2 Select a port/LAG.

The following fields are displayed:

- **Frames Received** — The number of valid EAPOL frames received on the port.
- **Frames Transmitted** — The number of EAPOL frames transmitted via the port.

- **Start Frames Receive** — The number of EAPOL Start frames received on the port.
 - **Log off Frames Receive** — The number of EAPOL Logoff frames received on the port.
 - **Respond ID Frames Receive** — The number of EAP Resp/ID frames received on the port.
 - **Respond Frames Receive** — The number of valid EAP Response frames received on the port.
 - **Request ID Frames Transmit** — The number of EAP Req/ID frames transmitted via the port.
 - **Request Frames Transmitted** — The number of EAP Request frames transmitted via the port.
 - **Invalid Frames Receive** — The number of unrecognized EAPOL frames received on this port.
 - **Length Error Frames Receive** — The number of EAPOL frames with an invalid Packet Body Length received on this port.
 - **Last Frame Version** — The protocol version number attached to the most recently received EAPOL frame.
 - **Last Frame Source** — The source MAC address attached to the most recently received EAPOL frame.
- 3** Select one of the **Refresh Rate** options to specify how frequently the statistics should be refreshed.

Viewing EAP Statistics Using the CLI Commands

The following table summarizes the CLI commands for viewing EAP statistics.

Table 21-4. EAP Statistics CLI Commands

CLI Command	Description
<code>show dot1x statistics</code>	Displays 802.1X statistics for the specified interface.

The following is an example of the CLI commands:

```
console# show dot1x statistics gi1/0/1
EapolFramesRx: 11
EapolFramesTx: 12
EapolStartFramesRx: 1
EapolLogoffFramesRx: 1
EapolRespIdFramesRx: 3
EapolRespFramesRx: 6
EapolReqIdFramesTx: 3
EapolReqFramesTx: 6
InvalidEapolFramesRx: 0
EapLengthErrorFramesRx: 0
LastEapolFrameVersion: 1
LastEapolFrameSource: 0008.3b79.8787
```

RMON Components

This section describes Remote Monitoring (RMON), which enables network managers to display network information from a remote location.

It contains the following topics:

- Statistics
- History Control
- History Table
- Events Control
- Events Log
- Alarms

Statistics

To display device utilization statistics and errors that occurred on the device:

- 1 Click **Statistics/RMON > RMON > Statistics** in the tree view to display the **Statistics** page.

Figure 21-8. Statistics

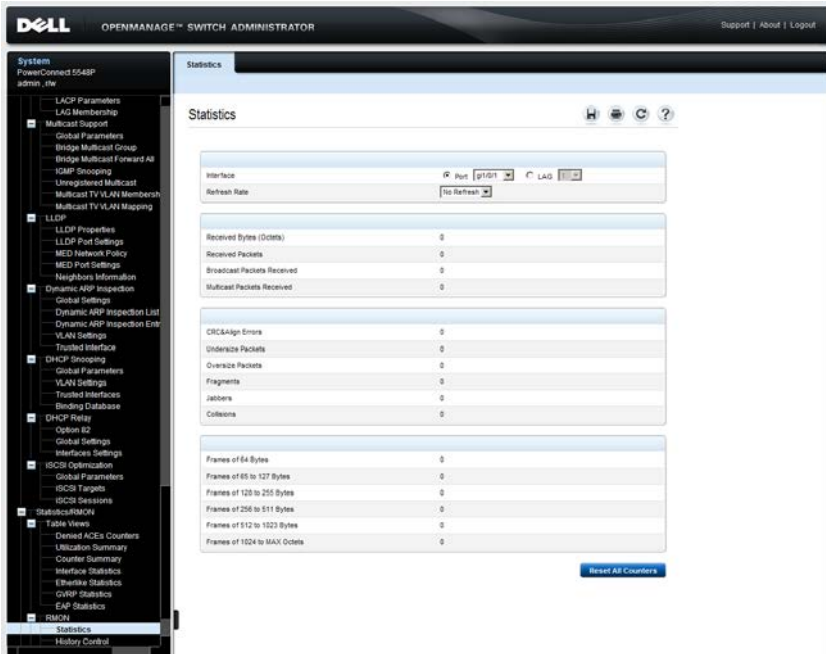

- 2 Select a port/LAG.

The following fields are displayed:

- **Received Bytes (Octets)** — Number of bytes received on the selected interface.
- **Received Packets** — Number of packets received on the selected interface.
- **Broadcast Packets Received** — Number of good Broadcast packets received on the interface since the device was last refreshed. This number does not include Multicast packets.

- **Multicast Packets Received** — Number of good Multicast packets received on the interface, since the device was last refreshed.
- **CRC&Align Errors** — Number of packets received with a length (excluding framing bits, but including FCS octets) of between 64 and 1518 octets, inclusive, but with either a bad Frame Check Sequence (FCS) with an integral number of octets (FCS Error) or a bad FCS with a non-integral number of octets (Alignment Error).
- **Undersize Packets** — Number of packets received, less than 64 octets long (excluding framing bits, but including FCS octets), and otherwise well formed.
- **Oversize Packets** — Number of packets received, longer than 1518 octets (excluding framing bits, but including FCS octets), and otherwise well formed.
- **Fragments** — Number of packets received, less than 64 octets in length (excluding framing bits but including FCS octets), which has either a bad Frame Check Sequence (FCS) with an integral number of octets (FCS Error), or a bad FCS with a non-integral number of octets (Alignment Error).
- **Jabbers** — Number of packets received, longer than 1518 octets (excluding framing bits, but including FCS octets), and having either a bad Frame Check Sequence (FCS) with an integral number of octets (FCS Error), or a bad FCS with a non-integral number of octets (Alignment Error).
- **Collisions** — Number of collisions received on the interface, since the device was last refreshed.
- **Frames of 64 Bytes** — Number of 64-byte frames received on the interface, since the device was last refreshed.
- **Frames of 65 to 127 Bytes** — Number of 65-127-byte frames received on the interface, since the device was last refreshed.
- **Frames of 128 to 255 Bytes** — Number of 128-255-byte frames received on the interface, since the device was last refreshed.
- **Frames of 256 to 511 Bytes** — Number of 256-511-byte frames received on the interface, since the device was last refreshed.
- **Frames of 512 to 1023 Bytes** — Number of 512-1023-byte frames received on the interface, since the device was last refreshed.

- **Frames of 1024 to Max Octets** — Number of 1024-Max Octet frames received on the interface, since the device was last refreshed.
- 3** Select one of the **Refresh Rate** options to specify how frequently the statistics should be refreshed.

Configuring RMON Statistics Using the CLI Commands

The following table contains the CLI commands for viewing and enabling RMON statistics.

Table 21-5. Configuring RMON Statistics Using CLI Command

CLI Command	Description
<code>show rmon statistics</code> <code>{[gigabitethernet tengigabitethernet] interface/port-channel LAG-number}</code>	Displays RMON Ethernet statistics.

The following is an example of the CLI commands:

```

console# show rmon statistics gi1/0/1
Port tel/0/1
Dropped: 0
Octets: 0 Packets: 0
Broadcast: 0 Multicast: 0
CRC Align Errors: 0 Collisions: 0
Undersize Pkts: 0 Oversize Pkts: 0
Fragments: 0 Jabbers: 0
64 Octets: 0 65 to 127 Octets: 1
128 to 255 Octets: 1 256 to 511 Octets: 1
512 to 1023 Octets: 0 1024 to max Octets: 0

```

History Control

To display the requested RMON history group statistics or request a new sample of interface statistics:

- 1 Click **Statistics/RMON > RMON > History Control** in the tree view to display the **History Control: Summary** page.

Figure 21-9. History Control: Summary

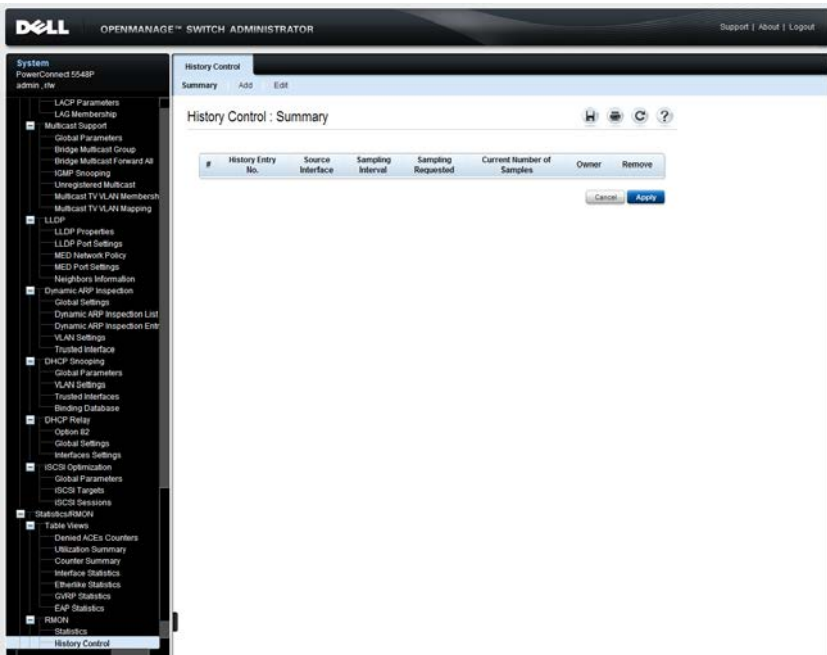

Previously-defined samples are displayed.

- 2 To add a new entry, click **Add**. The **New History Entry** number, which uniquely identifies the sample, is displayed.
- 3 Enter the fields for the entry:
 - **Source Interface** — Sampled Ethernet interface.
 - **Owner (0-20 characters)** — RMON station or user that configured the entry.

- **Max No. of Samples to Keep (1-50)** — Number of samples to be saved.
- **Sampling Interval (1-3600)** — The time interval in seconds between samples.

Configuring RMON History Control Using the CLI Commands

The following table contains the CLI commands for configuring RMON history control.

Table 21-6. RMON History Control CLI Commands

CLI Command	Description
rmon collection stats index [owner <i>ownername</i> bucket <i>bucket-number</i>] [interval <i>seconds</i>]	Enables and configures RMON on an interface.
no rmon collection stats index	Use the no form of this command to remove a specified RMON history group of statistics.
show rmon collection history [[<i>gigabitethernet</i> <i>tengigabitethernet</i>] <i>interface</i> / <i>port-channel LAG-number</i>]	Displays RMON collection history statistics.

The following is an example of the CLI commands:

```
console(config)# interface gi1/0/8
console(config-if)# rmon collection stats 1 interval 2400
```



History Table

The **History Table** page displays interface-specific statistical network samplings. Each table entry represents the counter values compiled during a single sample.

To display RMON statistics for a specified sample:

- 1 Click **Statistics/RMON > RMON > History Table** in the tree view to display the **History Table** page.

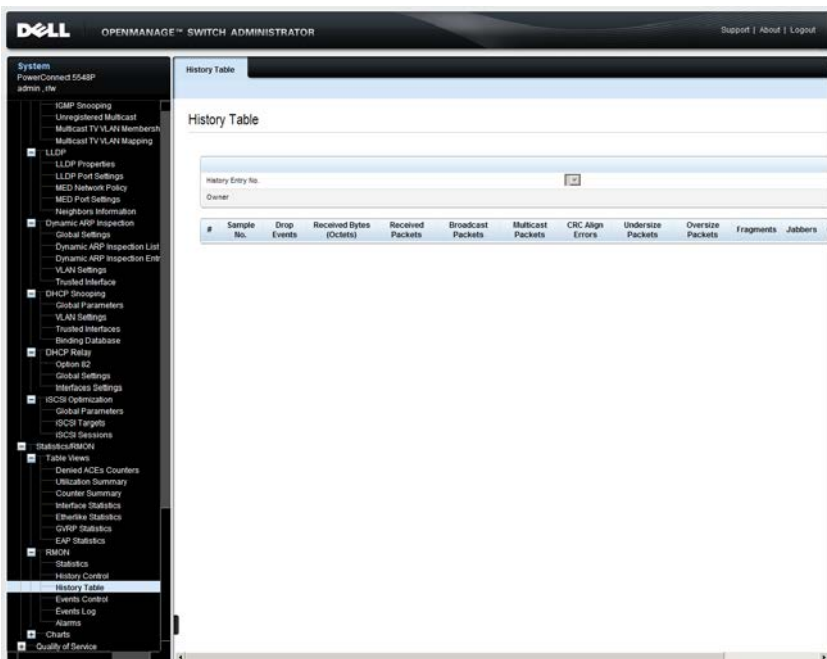
Figure 21-10. History Table



- 2 Select a **History Entry No.**

The following fields are displayed:

- **Owner** — RMON station or user that requested the RMON information.
- **Sample No.** — Number of the specific sample the information in the table reflects.

- **Drop Events** — Number of dropped packets due to lack of network resources during the sampling interval. This may not represent the exact number of dropped packets, but rather the number of times dropped packets were detected.
- **Received Bytes (Octets)** — Number of data octets, including bad packets, received on the network.
- **Received Packets** — Number of packets received during the sampling interval.
- **Broadcast Packets** — Number of good Broadcast packets received during the sampling interval.
- **Multicast Packets** — Number of good Multicast packets received during the sampling interval.
- **CRC Align Errors** — Number of packets received during the sampling session, with a length of between 64-1632 octets, who had a bad Check Sequence (FCS) with an integral number of octets, or a bad FCS with a non-integral number.
- **Undersize Packets** — Number of packets, having less than 64 octets, received during the sampling session.
- **Oversize Packets** — Number of packets having more than 1632 octets, received during the sampling session.
- **Fragments** — Number of packets, having less than 64 octets and having a FCS, received during the sampling session.
- **Jabbers** — Number of packets, having more than 1632 octets and who had an FCS, received during the sampling session.
- **Collisions** — Estimated number of packet collision that occurred during the sampling session. Collisions are detected when repeater port detects two or more stations transmitting simultaneously.
- **Utilization** — Estimated main physical layer network usage on an interface during the session sampling. The value is stated in hundredths of a percent.

Viewing the RMON History Table Using the CLI Commands

The following table contains the CLI commands for viewing the RMON history table.

Table 21-7. RMON History Table CLI Commands

CLI Command	Description
<code>show rmon history <i>index</i> {throughput errors other} [period <i>seconds</i>]</code>	Displays RMON Ethernet statistics history.

The following is an example of a CLI command:

```
console# show rmon history 1 throughput
Sample Set: 1
Interface: 1/0/1
Requested samples: 50
Owner: CLI
Interval: 1800
Granted samples: 50
Maximum table size: 500
Time
-----
Jan 18 2005 21:57:00
Octets
-----
303595962
Packets
-----
357568
Broadcast
-----
3289
Multicast
-----
7287
Util
-----
19%
```

Events Control

Events are actions that are performed when an alarm is generated (alarms are defined in the **Alarms** page).

An event can be any combination of logs/traps. If the action includes logging, then the events are logged in the **Events Log** page.

To define an RMON event:

- 1 Click **Statistics/RMON > RMON > Events Control** in the tree view to display the **Events Control: Summary** page.

Figure 21-11. Events Control: Summary

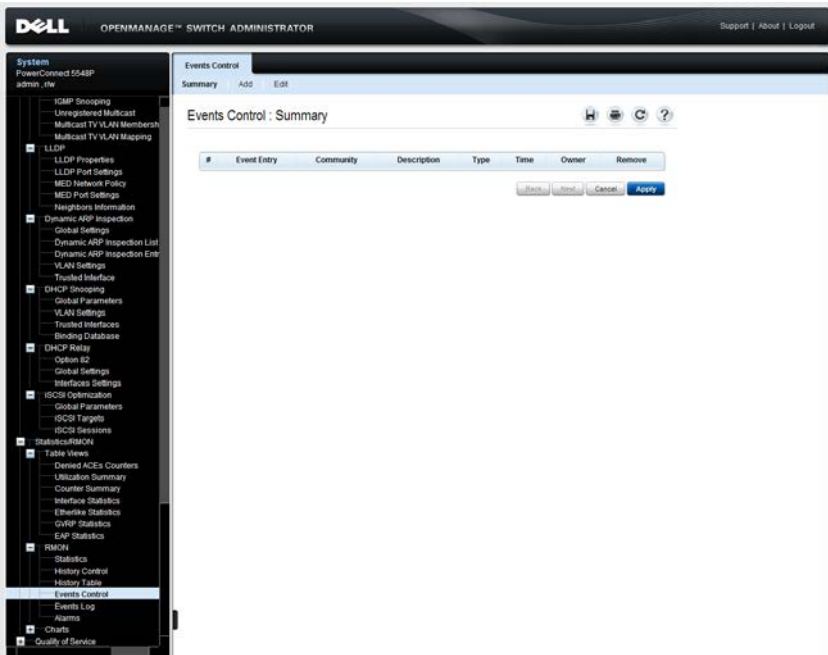

The currently-defined events are displayed. Along with the fields described in the **Events Control: Add** page, the following field is displayed for the events:

- **Time** — The time that the event occurred.

- 2 To define a new event, click **Add**.

3 Enter the fields:

- **Event Entry** — Displays a new event number.
- **Community** — Enter the community to which the event belongs or keep the default community.
- **Description** — Enter the event description.
- **Type** — Select the event action. The possible options are:
 - **None** — No action is taken.
 - **Log** — When an alarm occurs, a log entry is recorded.
 - **Trap** — When an alarm occurs, a trap is generated.
 - **Log and Trap** — When an alarm occurs, a log entry is recorded and a trap is generated.
- **Owner** — Enter the event owner.

Defining RMON Events Using the CLI Commands

The following table contains the CLI commands for defining RMON events.

Table 21-8. RMON Event Definition CLI Commands

CLI Command	Description
<code>rmon event index</code> { <code>none</code> <code>log</code> <code>trap</code> <code>log-trap</code> } [<code>community text</code>] [<code>description text</code>] [<code>owner name</code>]	Configures an event. Use the no form of this command to remove an event.
<code>no rmon event index</code>	
<code>show rmon events</code>	Displays RMON event table.

The following is an example of the CLI commands:

```
console(config)# rmon event 1 log
console(config)# exit
console# show rmon events
```

Index	Description	Type	Community	Owner	Last Time Sent
1	Errors	Log	Default Community	CLI	Jan 18 2002 23:58:17
2	High Broadcast	Log-Trap	Router	Manager	Jan 18 2002 23:59:48

Events Log

The Events log displays the log of events that occurred. An event is logged when the type of the event is **Log** or **Log and Trap**. The action in the event is performed when the event is bound to an alarm (see the **Alarms** page) and the conditions of the alarm have occurred.

To display the events log:

- Click **Statistics/RMON > RMON > Events Log** in the tree view to display the **Events Control** page.

Figure 21-12. Events Control

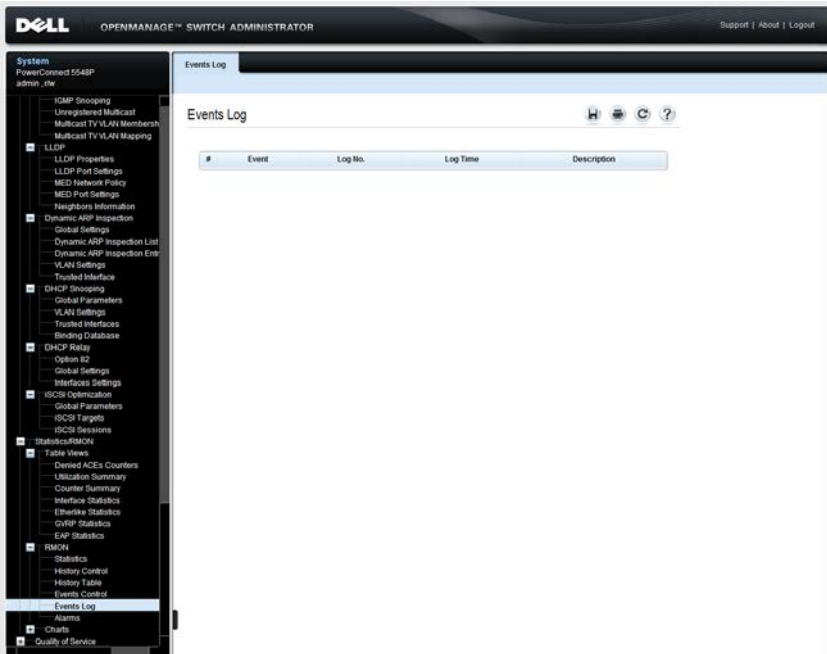

The following fields are displayed:

- **Event** — The event identifier.
- **Log No.** — The log number.
- **Log Time** — Time when the log entry was entered.

- **Description** — Description of the log entry.

Viewing Device Events Using the CLI Commands

The following table contains the CLI commands for viewing device events.

Table 21-9. Device Event Viewing CLI Commands

CLI Command	Description
<code>show rmon log [event]</code>	Displays the RMON logging table.

The following is an example of the CLI commands:

```
console(config)# rmon event 1 log
console> show rmon log
Maximum table size: 500
Event Description          Time
-----
1      Errors              Jan 18 2002 23:58:17
2      High Broadcast       Jan 18 2002 23:59:48
```

Alarms

RMON alarms provide a mechanism for setting thresholds and sampling intervals to generate exception events on a counter or any other SNMP object counter maintained by the agent.

Both the rising and falling thresholds must be configured in the alarm. After a rising threshold is crossed, another rising event is not generated until the companion falling threshold is crossed. After a falling alarm is issued, the next

alarm is issued when a rising threshold is crossed. One or more alarms are bound to an event. The event indicates the action to be taken when the alarm occurs.

To add an RMON alarm:

- 1 Click **Statistics/RMON > RMON > Alarms** in the tree view to display the **Alarms: Summary** page.

Figure 21-13. Alarms: Summary

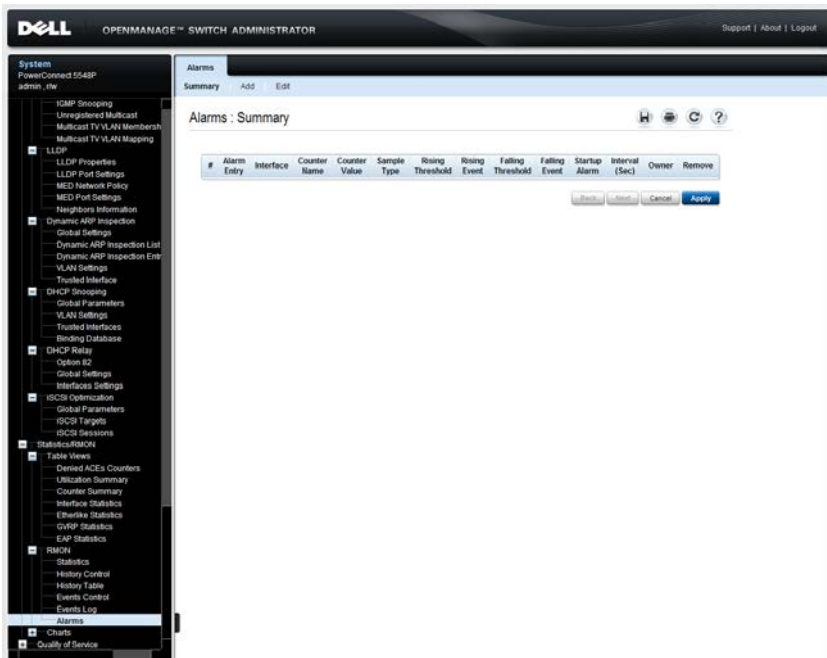

The currently-defined alarms are displayed.

- 2 To add a new alarm, click **Add** and enter the fields:
 - **Alarm Entry** — Displays a new alarm entry.
 - **Interface** — Select the interface for which RMON statistics are displayed.
 - **Counter Name** — Select the selected MIB variable.

- **Sample Type** — Select the sampling method for the selected variable and comparing the value against the thresholds. The possible options are:
 - **Delta** — Subtracts the last sampled value from the current value. The difference in the values is compared to the threshold.
 - **Absolute** — Compares the values directly with the thresholds at the end of the sampling interval.
- **Rising Threshold (0-2147483647)** — Enter the rising counter value that triggers the rising event alarm.
- **Rising Event** — Select one of the previously-defined events.
- **Falling Threshold (0-2147483647)** — Enter the falling counter value that triggers the falling event alarm.
- **Falling Event** — Select one of the previously-defined events.
- **Startup Alarm** — Select the trigger that activates the alarm. The possible options are:
 - **Rising Alarm** — A rising counter value triggers the alarm
 - **Falling Alarm** — A falling counter value triggers the alarm.
 - **Rising and Falling** — Both rising and falling counter values trigger the alarm.
- **Interval (1-2147483647)** — Enter the alarm interval time in seconds. This is the interval in seconds over which the data is sampled and compared with the rising and falling thresholds.
- **Owner** — Enter the name of the user or network management system that receives the alarm.

Defining Device Alarms Using the CLI Commands

The following table contains the CLI commands for defining device alarms.

Table 21-10. Device Alarm CLI Commands

CLI Command	Description
rmon alarm <i>index</i> <i>MIB_Object_ID interval</i> <i>rthreshold fthreshold</i> <i>revent fevent</i> [type <i>type</i>] [startup <i>direction</i>] [owner <i>name</i>]	Configures RMON alarm conditions. Use the no form of this command to remove an alarm.
no rmon alarm index	
show rmon alarm-table	Displays summary of the alarm table.
show rmon alarm <i>number</i>	Displays the RMON alarm configuration.

The following is an example of the CLI commands:

```
console(config)# rmon alarm 1000
1.3.6.1.2.1.2.2.1.10.1 360000 1000000 1000000 10 20
console# show rmon alarm-table
Index
-----
123
OID
-----
1.3.6.1.2.1.2.2.1.10.1
1.3.6.1.2.1.2.2.1.10.1
1.3.6.1.2.1.2.2.1.10.9
Owner
-----
CLI
Manager
CLI
```

Charts

This section describes how to display statistics as charts.

It contains the following topics:

- Ports
- LAGs
- CPU Utilization

Ports

To display port statistics in chart format:

- 1 Click **Statistics/RMON > Charts > Ports** in the tree view to display the Ports page.

Figure 21-14. Ports

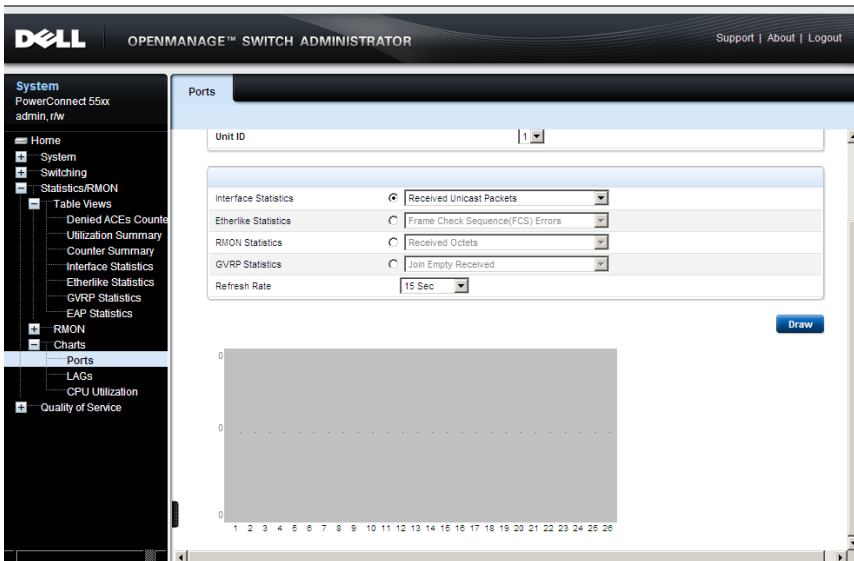

- 2 Select the unit ID of a unit in the stack for which you want to display statistics.

- 3** Check the type of statistics to be displayed:
 - **Interface Statistics** — Select the interface statistics to display.
 - **Etherlike Statistics** — Select the frame error statistics to display.
 - **RMON Statistics** — Select the RMON statistics to display.
 - **GVRP Statistics** — Select the GVRP statistics type to display.
 - **Refresh Rate** — Select the amount of time that passes before the statistics are refreshed.
- 4** To draw a chart for the selected statistics, click **Draw**. The chart for the selected statistic is displayed on the page.

Viewing Port Statistics Using the CLI Commands

The CLI commands for viewing port statistics are the same CLI commands described above. The **Ports** page simply shows the same statistics in chart form.

LAGs

To display LAG statistics in chart format:

- 1 Click **Statistics/RMON > Charts > LAGs** in the tree view to display the LAGs page.

Figure 21-15. LAGs

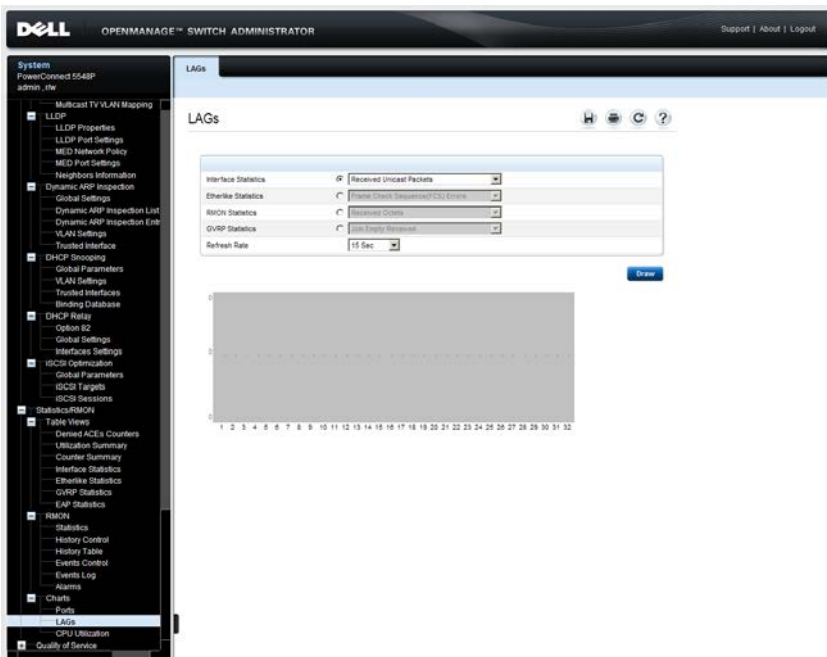

- 2 Check the type of statistics to be displayed:
 - **Interface Statistics** — Select the interface statistics to display.
 - **Etherlike Statistics** — Select the frame error statistics to display.
 - **RMON Statistics** — Select the RMON statistics to display.

- **GVRP Statistics** — Select the GVRP statistics type to display.
 - **Refresh Rate** — Select the amount of time that passes before the statistics are refreshed.
- 3** To draw a chart for the selected statistics, click **Draw**. The chart for the selected statistic is displayed on the page.

Viewing LAG Statistics Using the CLI Commands

The following table contains the CLI commands for viewing LAG statistics.

Table 21-11. LAG Statistic CLI Commands

CLI Command	Description
<code>show interfaces counters</code> <code>[[gigabitethernet tengigabitethernet] interface port-channel LAG-number]</code>	Displays traffic seen by the physical interface.
<code>show rmon statistics</code> <code>{[gigabitethernet tengigabitethernet] interface port-channel LAG-number}</code>	Displays RMON Ethernet statistics.
<code>show gvrp statistics</code> <code>{[gigabitethernet tengigabitethernet] interface port-channel LAG-number}</code>	Displays GVRP statistics.
<code>show gvrp-error statistics</code> <code>{[gigabitethernet tengigabitethernet] interface port-channel LAG-number}</code>	Displays GVRP error statistics.

The following is an example of the CLI commands:

```
console# show rmon statistics gil/0/1
Port gil/0/1
Dropped: 0
Octets: 0 Packets: 0
Broadcast: 0 Multicast: 0
CRC Align Errors: 0 Collisions: 0
Undersize Pkts: 0 Oversize Pkts: 0
Fragments: 0 Jabbers: 0
64 Octets: 0 65 to 127 Octets: 1
128 to 255 Octets: 1 256 to 511 Octets: 1
512 to 1023 Octets: 0 1024 to max Octets: 0
```

CPU Utilization

Use the **CPU Utilization** page to display the system's CPU utilization and percentage of CPU resources consumed by each unit in the stack. Each unit in the stack is assigned a color on the graph.

To display CPU utilization in chart format:

- 1 Click **Statistics/RMON > Charts > CPU Utilization** in the tree view to display the **CPU Utilization** page.

Figure 21-16. CPU Utilization

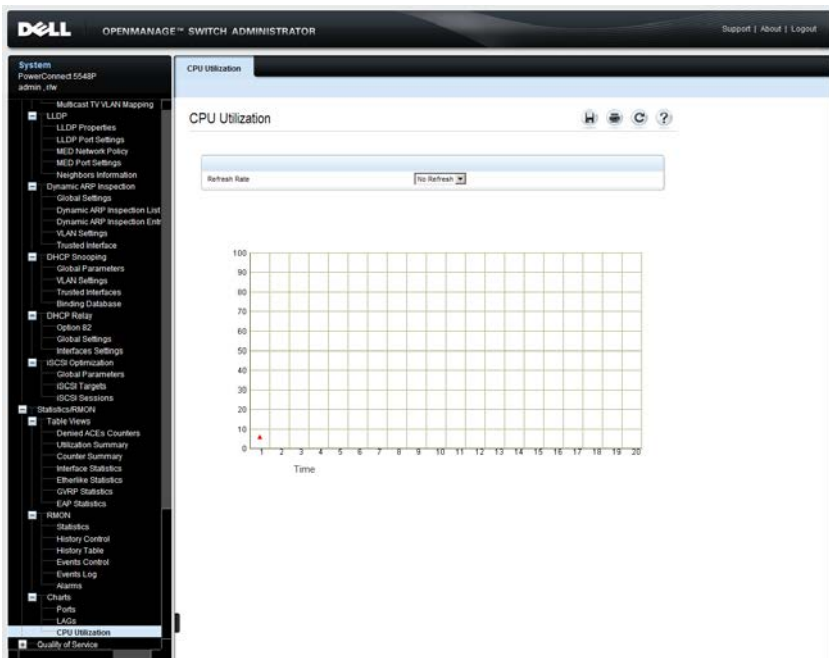

- 2 Select the **Refresh Rate** to specify how frequently the statistics should be refreshed.
- 3 The CPU utilization chart is displayed.

Viewing CPU Utilization Using CLI Commands

The following table summarizes the CLI commands for viewing CPU utilization.

Table 21-12. CPU Utilization CLI Commands

CLI Command	Description
<code>show cpu utilization</code>	Displays CPU utilization.

The following is an example of the CLI commands:

```
console# show cpu utilization
CPU utilization service is on.
CPU utilization
-----
five seconds: 5%; one minute: 3%; five minutes: 3%
```

Quality of Service

This section provides information for configuring Quality of Service (QoS).

It contains the following topics:

- QoS Features and Components
- General
- QoS Basic Mode
- QoS Advanced Mode
- QoS Statistics

QoS Features and Components

The QoS feature is used to optimize network performance. It provides classification of incoming traffic into traffic classes, based on one or more attributes, including:

- Device configuration
- Ingress interface
- Packet contents

QoS includes the following features:

- **Traffic Classification** — Classifies each incoming packet, as belonging to a specific traffic flow, based on the packet contents and/or interface. The classification is done by an ACL (Access Control List), and only traffic that meets the ACL criteria is subject to classification.
- **Assignment to Hardware Queues** — Assigns incoming packets to forwarding queues. Packets are sent to a particular queue for handling as a function of the traffic class to which they belong.
- **Other Traffic Class-Handling Attribute** — Applies QoS mechanisms to various classes, including bandwidth management.

QoS Modes

A single QoS mode is selected and applies to all interfaces in the system. The modes are:

- **Basic Mode — Class of Service (CoS).**
 - Traffic is divided into classes that determine how it is treated. All traffic in a class is treated with the same QoS action. The QoS action for the class of traffic determines the egress queue on the egress port, based on the indicated QoS value in the incoming frame.

The QoS value in the incoming frame is:

- **Layer 2 Packets** — VLAN Priority Tag (VPT) 802.1p value
- **Layer 3 IPv4 Frames** — Differentiated Service Code Point (DSCP) value
- **Layer 3 IPv6 Frames** — Traffic Class (TC) value

When operating in Basic mode, the switch trusts this externally-assigned QoS value.

This is the default QoS mode.

- **Advanced Mode — Per-flow Quality of Service (QoS).**

In Advanced mode, a per-flow QoS consists of a class map and a policer:

- A class map defines the kind of traffic in a flow, and contains one or more ACLs. Packets that match the ACLs belong to the flow.
- A policer applies the configured QoS to a flow. The QoS configuration of a flow may consist of the egress queue, the DSCP or CoS value, and actions on out-of-profile (excess) traffic.

- **Disable Mode (QoS is not enabled)**

In this mode, all traffic is mapped to a single best-effort queue, so that no type of traffic is prioritized over another.

Only a single mode can be active at a time. When the system is configured to work in QoS Advanced mode, settings for QoS Basic mode are not active and vice versa.

When the QoS mode is changed, the following occurs:

- When changing from Advanced mode to any other mode, policy profile definitions and class maps are deleted. ACLs, which are bonded directly to interfaces, remain bonded.
- When changing from Basic mode to Advanced mode, the QoS Trust mode configuration in Basic mode is not retained.
- When disabling QoS, the shaper and queue setting (WRR/SP bandwidth settings) are reset to default values.

All other user configurations remain intact.

General

This section contains the following topics:

- QoS Mode
- QoS Properties
- Queue
- Mapping to Queue
- Bandwidth
- TCP Congestion Avoidance

QoS Mode

To enable/disable the QoS mode:

- 1 Click **Quality of Service > General > QoS Mode** in the tree view to display the **QoS Mode** page.

Figure 22-1. QoS Mode

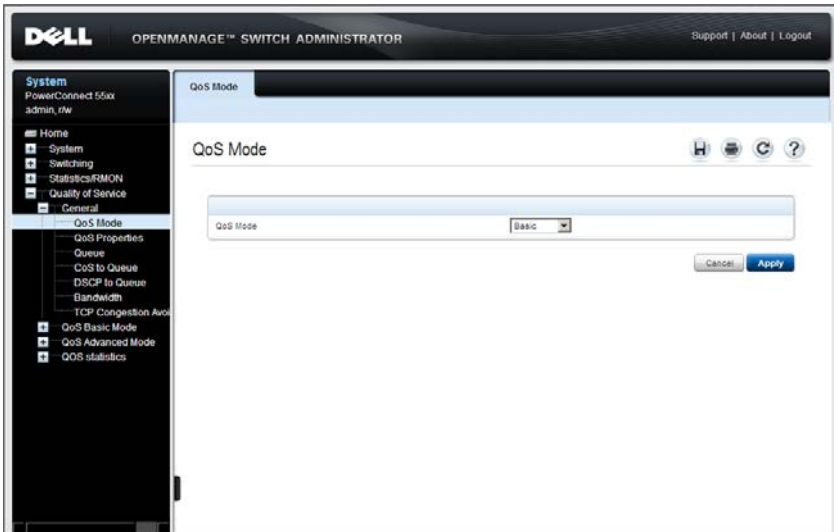

- 2 Select the **QoS Mode**. The possible options are:
 - **Basic** — QoS is enabled in Basic mode on the switch

- **Advanced** — QoS is enabled in Advanced mode on the switch.
- **Disable** — QoS is not enabled on the switch.

Setting QoS Mode Using CLI Commands

The following table summarizes the CLI commands for setting the QoS mode.

Table 22-1. QoS Mode CLI Commands

CLI Command	Description
<code>qos [basic advanced]</code>	Enables QoS on the device.
<code>no qos</code>	Use the no form of this command to disable QoS on the device
<code>show qos</code>	Displays the QoS mode.

The following is an example of the CLI commands:

```
console(config)# qos basic
```

QoS Properties

To set the default CoS value on incoming, untagged packets:

- 1 Click **Quality of Service > General > QoS Properties** in the tree view to display the **QoS Properties: Summary** page.

Figure 22-2. QoS Properties: Summary

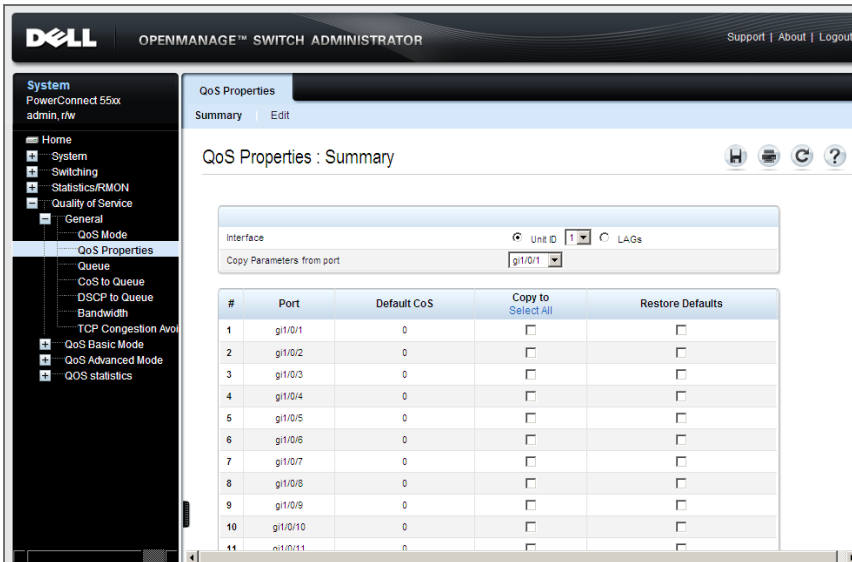

The default CoS values for all interfaces on the selected unit are displayed.

- 2 To modify the CoS value for an interface, click **Edit**, and enter the fields:
 - **Interface** — Select a port or LAG if required.
 - **Set Default CoS** — Enter the default CoS tag value for untagged packets.

Configuring QoS Properties Using CLI Commands

The following table summarizes the CLI commands for configuring fields in the [QoS Properties: Summary](#) page.

Table 22-2. QoS Properties CLI Commands

CLI Command	Description
<code>qos cos default-cos</code>	Defines the default CoS value of a port.
<code>no qos cos</code>	Use the no form of this command to restore the default configuration.

The following is an example of the CLI command:

```
console(config)# interface gi1/0/15
console(config-if)# qos cos 3
```

Queue

The switch supports eight queues for each interface. Queue number eight is the highest priority queue. Queue number one is the lowest priority queue.

Traffic Limitation Methods

There are two ways of determining how traffic in queues is handled, Strict Priority and Weighted Round Robin (WRR):

- **Strict Priority** — Egress traffic from the highest-priority queue is transmitted first. Traffic from the lower queues is processed only after the highest queue has been transmitted, thus providing the highest level of priority of traffic to the lowest-numbered queue.
- **Weighted Round Robin (WRR)** — In WRR mode, the number of packets sent from the queue is proportional to the weight of the queue (the higher the weight, the more frames are sent). For example, if all eight queues are WRR and the default weights are used, queue 1 receives 1/15 of the bandwidth (assuming all queues are saturated and there is congestion), queue 2 receives 2/15, queue 3 receives 4/15, and queue 8 receives 8/15 of the bandwidth. The type of WRR algorithm used in the device is not the standard Deficit WRR (DWRR), but rather Shaped Deficit WRR (SDWRR).

Combination of WRR and Strict Priority

The priority for handling traffic can be selected for each queue. When the queuing mode is Weighted Round Robin for all queues, queues are serviced according to their weights. If all queues are assigned strict priority, queues are serviced according to that order.

The following is true if some queues are assigned strict priority and others are assigned WRR:

- If one queue is assigned strict priority, all higher queues are also assigned strict priority. Conversely, if a queue is assigned a WRR weight, all lower queues must also have a WRR weight assigned to them.
- In the above case, traffic for the strict priority queues is always sent before traffic from the WRR queues. Traffic from the WRR queues is forwarded only after the strict priority queues have been emptied. The relative portion from each WRR queue depends on its weight.

To select the priority method and enter WRR weights:

- 1 Click **Quality of Service > General > Queue** in the tree view to display the **Queue** page.

Figure 22-3. Queue

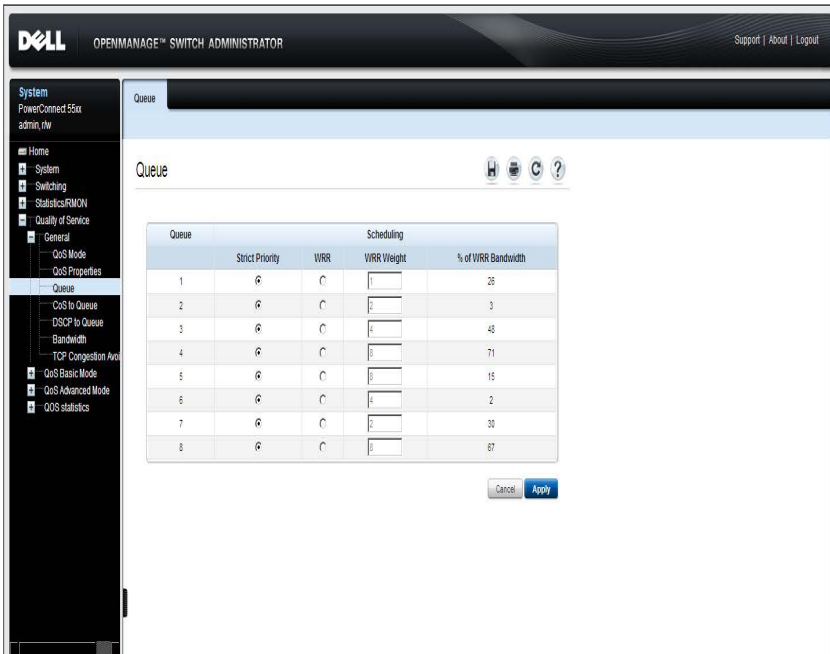

The queues are displayed.

- 2 Enter the parameters for the queues:
 - **Strict Priority** — Check to indicate that traffic scheduling for the selected queue, and all higher queues, is based strictly on the queue priority.
 - **WRR** — Check to indicate that traffic scheduling for the selected queue is based on WRR. The time period is divided between the WRR queues that are not empty, meaning they have descriptors to egress. This happens only if strict priority queues are empty.

- **Scheduling WRR Weight** — If WRR is selected, enter the WRR weight assigned to the queue.
- **% of WRR Bandwidth** — Displays the amount of bandwidth assigned to the queue. These values represent the percent of the WRR weight.

Configuring Queue Settings Using CLI Commands

The following table summarizes the CLI commands for configuring fields in the [Queue](#) page.

Table 22-3. Queue Setting CLI Commands

CLI Command	Description
priority-queue out num-of-queues <i>number-of-queues</i>	Configures the number of expedite queues.
no priority-queue out num-of-queues	Use the no form of this command to restore the default configuration.
wrr-queue bandwidth <i>weight1 weight2 ... weight_n</i>	Assigns WRR weights to egress queues.
no wrr-queue bandwidth	Use the no form of this command to restore the default configuration.

The following is an example of the CLI commands:

```
console(config)# priority-queue out num-of-queues 2
console(config-if)# wrr-queue bandwidth 6 6 6 6 6 6
```

Mapping to Queue

This section provides information for mapping DSCP and CoS values to service queues, and contains the following topics:

- CoS to [Queue](#)
- DSCP to [Queue](#)

CoS to Queue

The **CoS to Queue** page maps CoS priorities to an egress queue, meaning that the egress queues of the incoming packets is based on the CoS priority in their VLAN Tags. For incoming, untagged packets, the CoS priority is the default CoS priority assigned to ingress ports.

By changing CoS to Queue mapping, Queue schedule method, and bandwidth allocation, it is possible to achieve the desired quality of services in a network.

The CoS to Queue mapping is applicable only if one of the following exists:

- The switch is in QoS Basic mode, and CoS is the trusted mode.
- The switch is in QoS Advanced mode, and the packets belong to flows that are CoS trusted.

To map CoS values to egress queues:

- 1 Click **Quality of Service > General > CoS to Queue** in the tree view to display the **CoS to Queue** page.

Figure 22-4. CoS to Queue

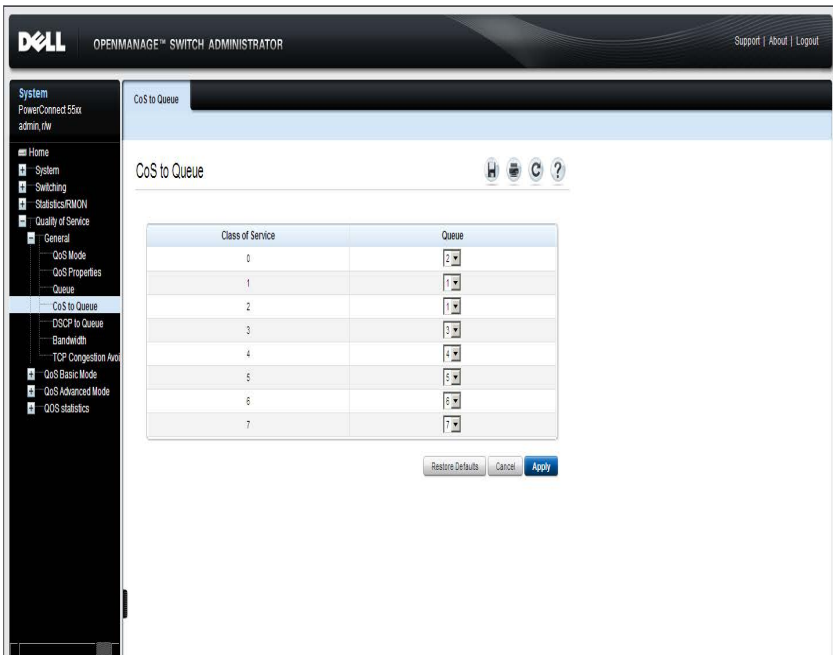

The CoS/queue mappings are displayed.

- 2 Enter the fields:
 - **Class of Service** — The CoS priority tag values, where zero is the lowest priority and 7 is the highest priority.
 - **Queue** — The queue to which the CoS priority is mapped.

Mapping CoS Priorities to Queues Using CLI Commands

The following table summarizes the CLI commands for configuring fields in the CoS to Queue page .

Table 22-4. CoS to Queue CLI Commands

CLI Command	Description
<code>wrr-queue cos-map queue-id cos1 ... cos8</code>	Maps CoS values to the egress queues.
<code>no wrr-queue cos-map [queue-id]</code>	Use the no form of this command to restore the default configuration.

The following is an example of the CLI commands:

```
console(config)# wrr-queue cos-map 4 7
```

DSCP to Queue

The DSCP to Queue mapping determines the egress queues of the incoming IP packets, based on their DSCP values. The original VPT (VLAN Priority Tag) of the packet is unchanged.

By changing the DSCP to Queue mapping, the Queue schedule method, and bandwidth allocation, it is possible to achieve improved quality of service in a network.

The DSCP to Queue mapping is applicable to IP packets when:

- The switch is in Basic mode and DSCP is the trusted mode
- The switch is in Advanced mode and the packets belongs to flows that are DSCP trusted

Non-IP packets are always classified to the best-effort queue.

To map DSCP to queues:

- 1 Click **Quality of Service > General > DSCP to Queue** in the tree view to display the **DSCP to Queue** page.

Figure 22-5. DSCP to Queue

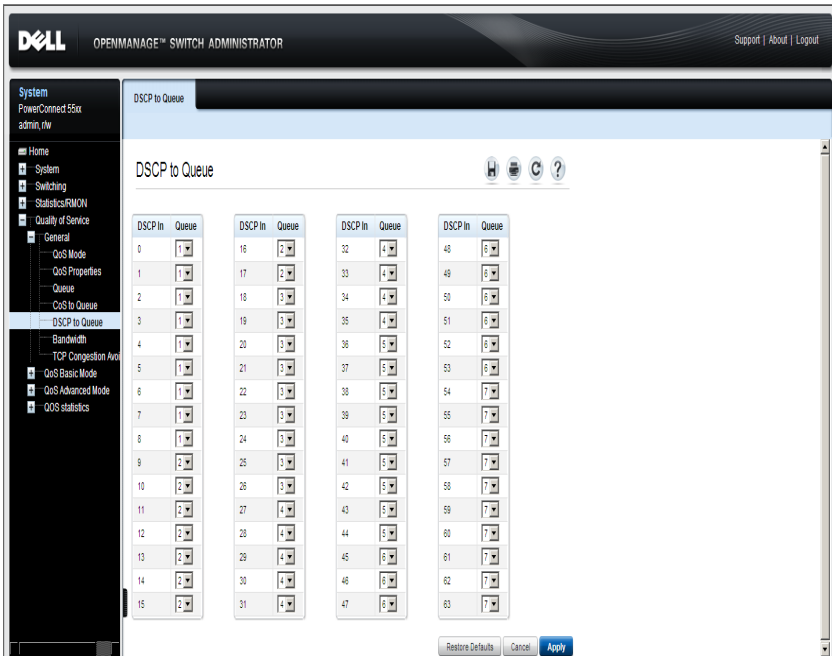

The DSCP values in the incoming packet and its associated queues are displayed.

- 2 Enter the fields:

- **DSCP In** — The values of the DSCP field in the incoming packet.
- **Queue** — The queue to which packets with the specific DSCP value is assigned. The values are 1-8, where 1 is the lowest value, and 8 is the highest.

Mapping DSCP Values to Queues Using CLI Commands

The following table summarizes the CLI commands for configuring fields in the DSCP to [Queue](#) page.

Table 22-5. DSCP to Queue CLI Commands

CLI Command	Description
<code>qos map dscp-queue dscp-list to queue-id</code>	Modifies the DSCP to queue mapping.
<code>no qos map dscp-queue [dscp-list]</code>	Use the no form of this command to restore the default configuration.

The following is an example of the CLI command:

```
console(config)# qos map dscp-queue 33 40 41 to 1
```

Bandwidth

The amount of traffic that can be received and transmitted on an interface can be limited by the following:

- **Ingress Rate Limit** — Number of bits per second that can be received from the ingress interface. Excess bandwidth above this limit is discarded.
- **Egress Shaping Rates** is defined by the following:
 - Committed Information Rate (CIR) sets the average maximum amount of data allowed to be sent on the egress interface, measured in bits per second
 - Committed Burst Shape (CBS) sets the maximum burst of data that is allowed to be sent, even though it is above the CIR. This is defined in number of bytes of data.

To configure bandwidth limitation:

- 1 Click **Quality of Service > General > Bandwidth** in the tree view to display the **Bandwidth: Summary** page.

Figure 22-6. Bandwidth: Summary

The screenshot shows the Dell OpenManage Switch Administrator interface. The left sidebar contains a navigation tree with the following items: System, PowerConnect 55xx, admin, rw, Home, System, Switching, Statistics/RMON, Quality of Service, General, QoS Mode, QoS Properties, Queue, COS to Queue, DSCP to Queue, Bandwidth, TCP Congestion Avoidance, QoS Basic Mode, QoS Advanced Mode, and QoS statistics. The main content area is titled "Bandwidth: Summary" and includes a "Summary" tab and an "Edit" button. Below the title is a form for interface configuration with fields for "Interface" (set to g1/0/1), "Unit D", "LAGs", and "Copy Parameters from port". A table below the form lists 12 ports with their respective Ingress Rate Limit and Egress Shaping Rates (CIR, CBS).

#	Port	Ingress Rate Limit		Egress Shaping Rates			Copy to
		Status	Rate Limit	Status	CIR	CBS	
1	g1/0/1	Disable	0	Disable	0	128000	<input type="checkbox"/>
2	g1/0/2	Disable		Disable			<input type="checkbox"/>
3	g1/0/3	Disable	0	Disable	0	128000	<input type="checkbox"/>
4	g1/0/4	Disable		Disable			<input type="checkbox"/>
5	g1/0/5	Disable		Disable			<input type="checkbox"/>
6	g1/0/6	Disable		Disable			<input type="checkbox"/>
7	g1/0/7	Disable		Disable			<input type="checkbox"/>
8	g1/0/8	Disable		Disable			<input type="checkbox"/>
9	g1/0/9	Disable		Disable			<input type="checkbox"/>
10	g1/0/10	Disable		Disable			<input type="checkbox"/>
11	g1/0/11	Disable		Disable			<input type="checkbox"/>
12	g1/0/12	Disable		Disable			<input type="checkbox"/>

The ingress and egress rates are displayed for all ports on the selected unit.

- 2 To set interface parameters, click **Edit**.
- 3 Select an interface, and enter the fields:
 - **Enable Ingress Rate Limit** — Enable/disable ingress traffic limit for the interface. If this field is selected, enter the Ingress Rate Limit.
 - **Ingress Rate Limit** — Enter the ingress traffic limit for the interface.

- **Egress Shaping Rate** — Enable/disable egress traffic limitation. If this field is selected, enter the following fields.
- **Committed Information Rate (CIR)** — Enter the average maximum amount of data allowed to be sent on the egress interface, measured in bits per second.
- **Committed Burst Size (CBS)** — Enter the maximum burst of data that is allowed to be sent on the egress interface, even though it is above the CIR. This is defined in number of bytes of data.

Configuring Bandwidth Using CLI Commands

The following table summarizes the CLI commands for configuring fields in the **Bandwidth** pages.

Table 22-6. Bandwidth CLI Commands

CLI Command	Description
traffic-shape <i>committed-rate</i> [<i>committed-burst</i>]	Sets shaper on egress port. Use no form in order to disable the shaper.
no traffic-shape	
rate-limit <i>committed-rate-kbps</i> [burst <i>committed-burst-byte</i>]	Limits the rate of the incoming traffic.
no rate-limit	Use the no form to disable rate limit.

The following is an example of the CLI commands:

```

console(config)# interface gil1/0/5
console(config-if)# traffic-shape 124000 9600
console(config-if)# rate-limit 150000

```

TCP Congestion Avoidance

Use the **TCP Congestion Avoidance** page to activate a congestion avoidance algorithm. The algorithm breaks up or prevents TCP global synchronization in a congested node, where the congestion is due to various sources sending packets with the same byte count.

To configure TCP congestion avoidance:

- 1 Click **Quality of Service > General > TCP Congestion Avoidance** in the tree view to display the **TCP Congestion Avoidance** page.

 **NOTE:** TCP Congestion Avoidance increases network reliability, but it also increases network traffic. Continue only if you are sure it will improve overall network performance. For this change to be effective you must save the configuration and reboot the device.

Figure 22-7. TCP Congestion Avoidance



- 2 Check **TCP Congestion Avoidance** to enable the algorithm.

Configuring TCP Congestion Avoidance Using CLI Commands

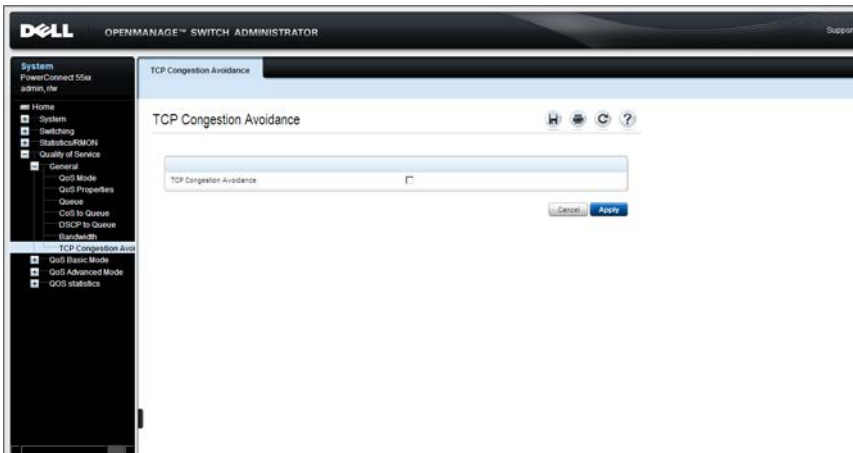
The following table summarizes the CLI commands for configuring fields in the TCP Congestion Avoidance page.

Table 22-7. TCP Congestion Avoidance CLI Commands

CLI Command	Description
<code>qos wrr-queue wrtd</code>	Enables Weighted Random Tail Drop (WRTD).
<code>no qos wrr-queue wrtd</code>	Use the no form of this command to disable WRTD.

The following is an example of the CLI commands:

```
console(config)# qos wrr-queue wrtd
```

```
This setting will take effect only after copying running configuration to startup configuration and resetting the device.
```

QoS Basic Mode

This section describes QoS Basic mode.

It contains the following topics:

- Basic Mode Overview
- Workflow to Configure Basic Mode
- Global Settings
- DSCP Rewrite
- Interface Settings

Basic Mode Overview

In QoS Basic mode, a specific domain in the network can be defined as trusted. Within that domain, packets are marked with CoS priority and/or DSCP values, to signal the type of service they require. Nodes within the domain use these fields to assign the packet to a specific output queue. The initial packet classification and marking of these fields is done in the ingress of the trusted domain.

Workflow to Configure Basic Mode

To configure Basic QoS mode, perform the following:

- 1 Select Basic mode for the system in the **QoS Mode** page.
- 2 Select the trust-behavior in the **Global Settings** page.
- 3 If there is any port that, as an exception, should not trust the incoming CoS mark, disable the QoS state on that port in the **Interface Settings** pages.

If a port is disabled without trusted mode, all its ingress packets are forwarded in best effort. It is recommended that you disable the trusted mode at the ports where the CoS and/or DSCP values in the incoming packets are not trustworthy. Otherwise, performance in the network might be negatively affected.

- 4 If you selected DSCP Rewrite in the **Global Settings** page, set the DSCP in/out values in the **DSCP Rewrite** page.

Global Settings

Use the **Global Settings** page to enable Trust on all interfaces on the switch. This configuration is only active when the QoS mode is Basic. Packets entering a QoS domain are classified at the edge of the QoS domain.

For more information on setting Trust mode on an interface, see "Interface Settings" on page 664.

To define Trust configuration:

- 1 Click **Quality of Service > QoS Basic Mode > Global Settings** in the tree view to display the **Global Settings** page.

Figure 22-8. Global Settings

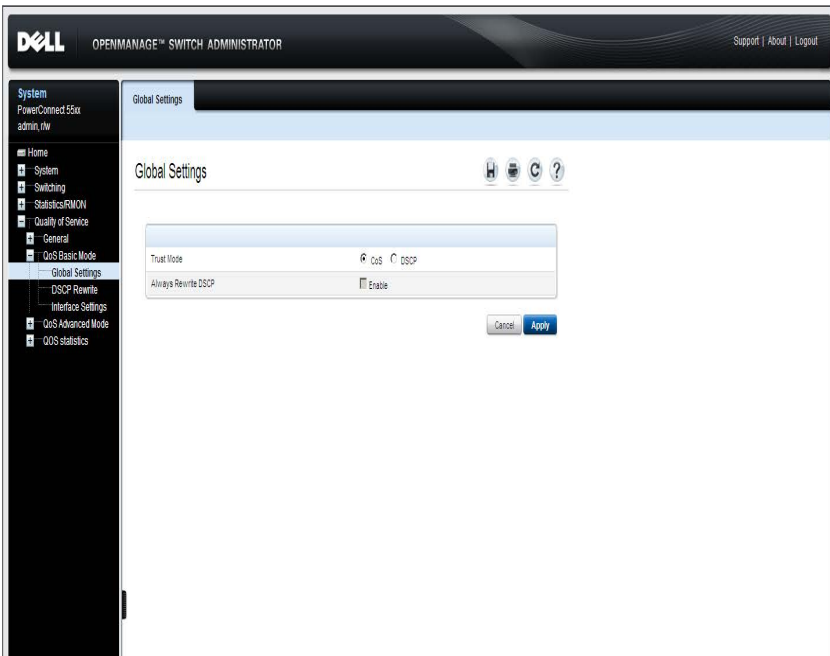

2 Enter the fields:

- **Trust Mode** — Enable/disable Trust mode.
 - **CoS** — Traffic is mapped to queues, based on the VPT field in the VLAN tag, or based on the per-port default CoS value (if there is no VLAN tag on the incoming packet). The mapping of the VPT to queue can be configured in the **CoS to Queue** page.
 - **DSCP** — All IP traffic is mapped to queues, based on the DSCP field in the IP header. The mapping of the DSCP to queue is configured in the **DSCP to Queue** page.
- **Always Rewrite DSCP** — Check to always rewrite the DSCP values in the incoming packets with the new values set in the **DSCP to Queue** page. When this field is enabled, the switch uses the new DSCP values to select the egress queue.

Assigning Global Settings Using CLI Commands

The following table summarizes the CLI commands for configuring fields in the **Global Settings** page.

Table 22-8. Global Settings CLI Commands

CLI Command	Description
<code>qos trust {cos dscp}</code> <code>no qos trust</code>	Configures the system to either the CoS or DSCP trust state. Use the no form of this command to return to the default configuration.
<code>qos dscp-mutation</code> <code>no qos dscp-mutation</code>	Applies the DSCP Mutation map to system DSCP trusted ports. Use the no form of this command to restore the trusted port with no DSCP mutation.

The following is an example of the CLI commands:

```
console(config)# qos trust dscp
console(config)# qos dscp-mutation
```

DSCP Rewrite

Use the **DSCP Rewrite** page to rewrite the DSCP tags for incoming traffic, when different DSCP values are used in the incoming and outgoing domains. Changing the DSCP value used in one domain to the DSCP value used in the other domain preserves the priority of traffic used in the first domain.

As an example, assume that there are three levels of service: Silver, Gold, and Platinum. The DSCP incoming values used to mark these levels are 10, 20, and 30 respectively. If this traffic is forwarded to another service provider that has the same three levels of service, but uses DSCP values 16, 24, and 48, the values set in the **DSCP Rewrite** page are used to change the incoming values to the outgoing values.

These settings are active globally when the system is in **QoS Basic** mode.

To map DSCP In values to DSCP Out values:

- 1 Click **Quality of Service > QoS Basic Mode > DSCP Rewrite** in the tree view to display the **DSCP Rewrite** page.

Figure 22-9. DSCP Rewrite

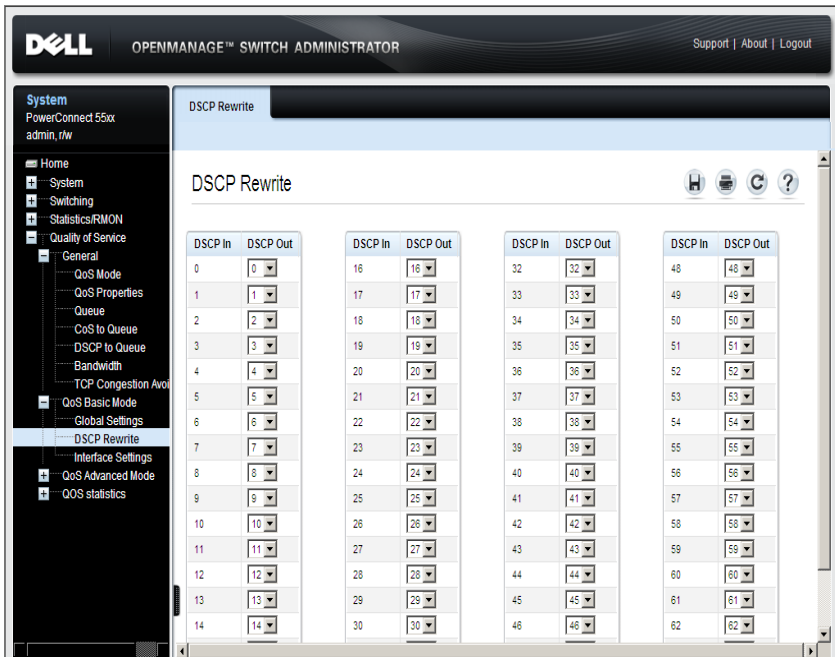

- 2 For each **DSCP In** value (DSCP value of the incoming packet) that needs to be rewritten to an alternative value, set a **DSCP Out** value.

Assigning DSCP Rewrite Values Using CLI Commands

The following table summarizes the CLI commands for configuring fields in the DSCP Rewrite page.

Table 22-9. DSCP Rewrite CLI Commands

CLI Command	Description
<code>qos map dscp-mutation in-dscp to out-dscp</code>	Configures the DSCP to DSCP Mutation table.
<code>no qos map dscp-mutation [in-dscp]</code>	Use the no form of this command to restore the default configuration.

The following is an example of the CLI commands:

```
console(config)# qos map dscp-mutation 1 2 4 5 6 to 63
```

Interface Settings

QoS Trust mode can be configured on each port of the switch, as follows:

- **QoS Trust State Disabled on an Interface** — All inbound traffic on the port is mapped to the best effort queue and no classification/prioritization takes place.
- **QoS Trust State Enabled on an Interface** — Port prioritized traffic on ingress is based on the system-wide configured trusted mode, which is either CoS Trusted mode or DSCP Trusted mode.

To define QoS Trust for an interface:

- 1 Click **Quality of Service** > **QoS Basic Mode** > **Interface Settings** in the tree view to display the **Interface Settings: Summary** page.

Figure 22-10. Interface Settings: Summary

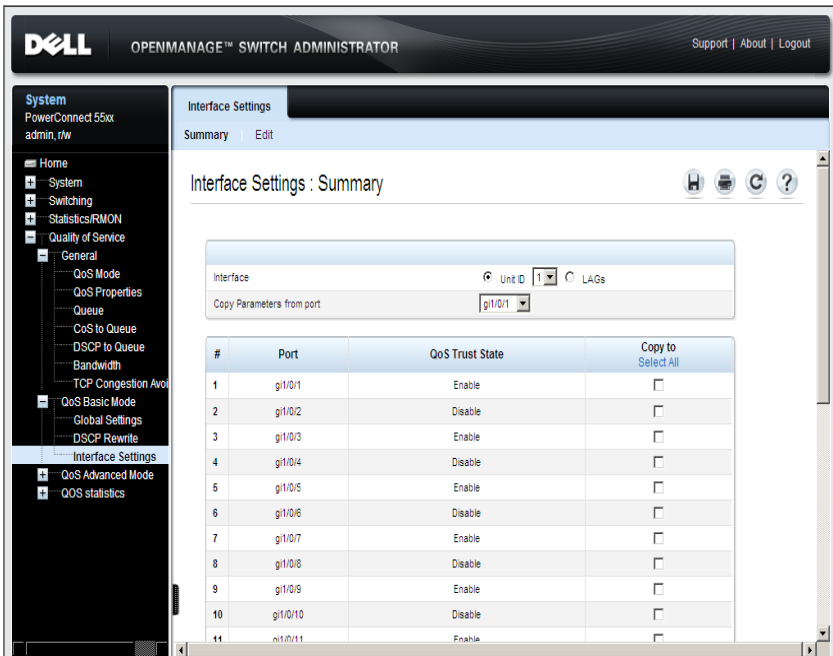

Trust mode is displayed for each interface on the selected unit.

- 2 To change the QoS trust state for an interface, click **Edit**, and select an interface on a unit.
- 3 Enable/disable the **QoS Trust State**.

Assigning Interface Settings Using CLI Commands

The following table summarizes the CLI commands for configuring fields in the Interface Settings page.

Table 22-10. Interface Settings CLI Commands

CLI Command	Description
<code>qos trust</code>	Enables each port trust state while the system is in the basic QoS mode.
<code>no qos trust</code>	Use the no form of this command to disable the trust state on each port.
<code>show qos interface[<i>buffers</i> <i>queueing</i> <i>policers</i> <i>shapers</i> <i>rate-limit</i>] [<i>interface-id</i>]</code>	Displays QoS information on the interface.

The following is an example of the CLI commands:

```
console(config)# interface gi1/0/15
console(config-if)# qos trust
```

Configuring QoS Basic Mode Using CLI Commands

The following is a sample script configuring QoS Basic mode.

Table 22-11. Sample CLI Script to Configure QoS Basic Mode

CLI Command	Description
<code>console#configure</code>	Enable QoS in Basic mode.
<code>console(config)# qos basic</code>	
<code>console(config)#mac access-list extended MAC1</code>	Define an ACL named "MAC1"
<code>console(config-mac-a1)#deny 00:00:00:00:00:11 00:00:00:00:00:ff any</code>	MAC1 discards all traffic with source MAC 00:00:00:00:00:XX addresses.
<code>console(config-mac-a1)# permit any any</code>	MAC1 permits all other traffic.
<code>console(config-mac-a1)#exit</code>	Exit ACL mode.

Table 22-11. Sample CLI Script to Configure QoS Basic Mode (Continued)

CLI Command	Description
<code>console(config)#interface gi1/0/1</code>	Enter Interface mode on port gi1/0/1.
<code>console(config-if)#service-acl input mac1</code>	Bind MAC1 to port gi1/0/1.

QoS Advanced Mode

This section describes QoS Advanced mode.

It contains the following topics:

- Advanced Mode Overview
- Workflow to Configure Advanced QoS Mode
- DSCP Mapping
- Class Mapping
- QoS Policers
- Policy Binding

Advanced Mode Overview

In Advanced mode, the switch uses policies to support per-flow QoS. A policy and its components have the following characteristics and relationships:

- A policy contains one or more class maps.
- A class map defines a flow with one or more associated ACLs. Packets that match the ACL rules (ACEs) in a class map with Permit (forward) action, belong to the same flow, and are subject to the same quality of service action. A policy can contain one or more flows, each with a user-defined QoS action.
- The QoS of a class map (flow) may be enforced by the associated policer. There are two type of policers, as described in "Defining Class Mapping Using CLI Commands" on page 674.
- Per-flow QoS actions are applied to flows by binding the policy maps to the desired ports. A policy map and its class maps can be bound to one or more ports, but each port is bound with, at the most, one policy map.

The following points should be considered:

- An ACL can be configured to one or more class maps, regardless of policies.
- A class map can belong to only one policy map.
- When a class map, using a single policer, is bound to multiple ports, each port has its own instance of the policer. Each instance applies the QoS actions on the class map (flow) at a port independent of each other.

- If you bind a policy map to more than one port and one of its classes contains a single policer, all policy map rules will be multiplied per port (using up more TCAM resources).
- An aggregate policer applies the QoS to all of its flows in aggregation, regardless of policies and ports.

Advanced QoS settings consist of the following elements:

- Rules — All frames matching a single group of rules are considered to be a flow.
- Actions — To be applied to frames in each flow that match the rules.
 - **Policers** — See "Single Policers" on page 679
 - **Aggregate Policers** — "Aggregate Policers" on page 677
 - **Trust** — "Interface Settings" on page 664, "Policy Class Maps" on page 682
 - **Set DSCP/CoS** — "Policy Class Maps" on page 682
 - **Set Queue** — "DSCP Mapping" on page 670
- Binding — Combination of rules and actions that are bound to one or more interfaces.

Workflow to Configure Advanced QoS Mode

To configure Advanced QoS mode, perform the following:

- 1 Select Advanced mode for the system in the **QoS Mode** page.
- 2 If external DSCP values are different from those used on incoming packets, map the external values to internal values in the **DSCP Rewrite** page.
- 3 Create ACLs, as described in "Network Security" on page 92.
- 4 When ACLs are defined, create class maps and associate the ACLs with them in the **Class Mapping** pages.
- 5 Create a policy map in the **Policy Class Maps** pages, and associate the policy map with one or more class maps. Specify the QoS action, if needed, for example by assigning a policer to a class map, when you associate the class map to the policy.

- a **Single Policer** — Create a policy that associates a class map with a single policer in the **Policy Table** pages and the **Class Mapping** pages. Within the policy, define the single policer.
 - b **Aggregate Policer** — Create a QoS action for each flow. This action sends all matching frames to the same policer (aggregate policer), defined in the **Aggregate Policer** pages. Create a policy that associates a class map with the aggregate policer in the **Policy Table** pages.
- 6 Bind the policy to an interface in the **Policy Binding** pages.

DSCP Mapping

When a policer is assigned to a class map (flow), you can specify the action to take when the amount of traffic in the flow(s) exceeds the QoS-specified limits. The portion of the traffic that causes the flow to exceed its QoS limit is referred to as **out-of-profile packets**.

If the exceed action is **Remark DSCP** (as opposed to **Drop**), the switch rewrites the original DSCP value of the out-of-profile IP packets to a new value, based on the values entered in the **DSCP Mapping** page. The switch uses the new values to assign resources and egress queues to these packets. The switch physically replaces the original DSCP value in the out-of-profile packets with the new DSCP value.

To use the **Remark DSCP** exceed action, set the DSCP Out value in the **DSCP Mapping** page. Otherwise the action is null, because the DSCP value in the packet is rewritten to the original DSCP value, set by factory default.

To set new DSCP values:

- 1 Click **Quality of Service > QoS Advanced Mode > DSCP Mapping** to display the DSCP Mapping page.

Figure 22-11. DSCP Mapping

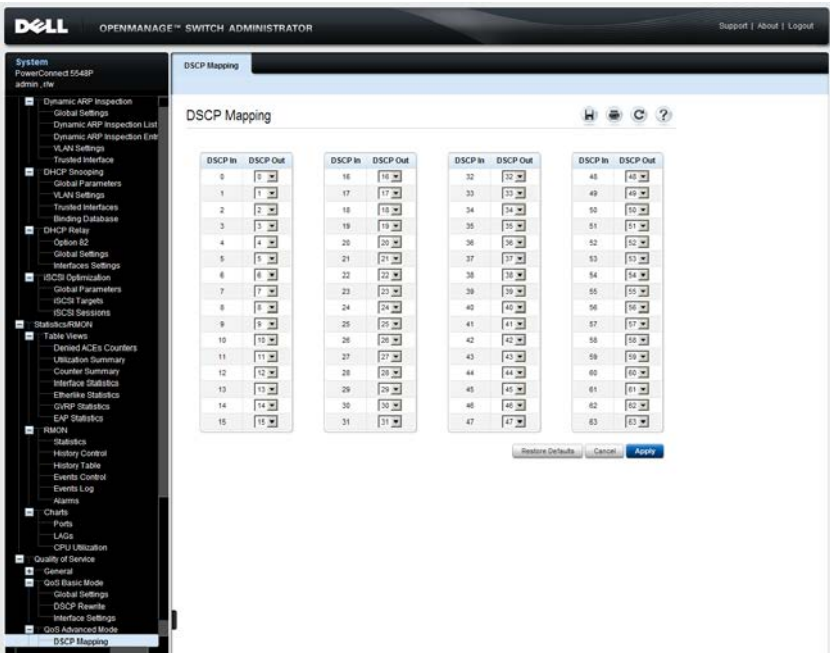

- 2 If the Exceed Action is **Out-of-Profile** (in the *Policy Class Maps* page) or **Remark DSCP** (in the *Aggregate Policy* page), the DSCP In values are rewritten with the DSCP Out values. Set the DSCP Out values as required.

Configuring DSCP Mapping Using CLI Commands

The following table summarizes the CLI commands for setting the fields in the DSCP Mapping page.

Table 22-12. DSCP Mapping CLI Commands

CLI Command	Description
<code>qos map policed-dscp <i>dscp-list</i> to <i>dscp-mark-down</i></code>	Configures the policed-DSCP map for remarking purposes.
<code>no qos map policed-dscp [<i>dscp-list</i>]</code>	Use the no form of this command to restore the default configuration.

The following is an example of the CLI commands:

```
console(config)# qos map policed-dscp 3 to 43
```

Class Mapping

A Class Map defines a traffic flow associated with ACL(s). A MAC-based ACL, IP-based ACL, and an IPv6-based ACL can be combined into a class map. Class maps are configured to match packet criteria on a match-all or match-any basis. They are matched to packets on a first-fit basis, meaning that the action associated with the first-matched class map is the action performed by the system. Packets that match the same class map belong to the same flow.

There are two possible types of matching:

- **match-all** — Traffic matches class map if it matches IP/IPV6 and MAC ACLs
- **match-any** — Traffic matches class map if it matches at least one of the ACLs

If a more complex set of rules is needed, several class maps can be grouped into a super-group called a policy (see "Defining Class Mapping Using CLI Commands" on page 674).

To define a class map:

- 1 Click **Quality of Service > QoS Advanced Mode > Class Mapping** to display the **Class Mapping: Summary** page.

Figure 22-12. Class Mapping: Summary

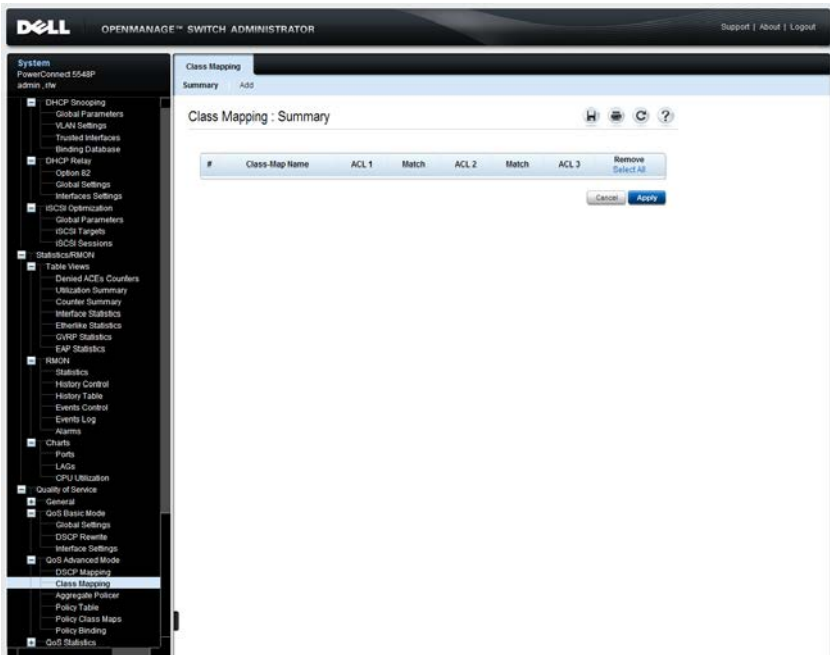

The previously-defined class maps are displayed.

- 2 To add a class map, click **Add**.

A new class map is added by selecting one or two ACLs and assigning them a class map name. If a class map has two ACLs, specify that a frame must match both ACLs, or that it must match either one or both of the ACLs selected.

- 3 Enter the parameters.

- **Class Map Name** — Enter the name of a new class map.

- **Match ACL Type** — Enter the criteria that a packet must match in order to belong to the flow defined by the class map. The possible options are:
 - **IP** — A packet must match either of the IP-based ACLs in the class map.
 - **MAC** — A packet must match the MAC-based ACL in the class map.
 - **IP and MAC** — A packet must match the IP-based ACL and the MAC-based ACL in the class map (match-all).
 - **IP or MAC** — A packet must match either the IP-based ACL or the MAC-based ACL in the class map (match-any).
- **IP ACL** — Select the IPv4-based ACL or the IPv6-based ACL for the class map.
- **MAC ACL** — Select the MAC-based ACL for the class map.
- **Preferred ACL** — Select whether packets are first matched to an IP-based ACL or a MAC-based ACL.

Defining Class Mapping Using CLI Commands

The following table summarizes the CLI commands for setting the fields in the Class Mapping pages.

Table 22-13. Class Mapping CLI Commands

CLI Command	Description
<code>class class-map-name [access-group acl-name]</code>	Defines a traffic classification and enters the Policy-map Class Configuration mode.
<code>no class class-map-name</code>	Use the no form of this command to detach a class map from the policy map.
<code>class-map class-map-name [match-all match-any]</code>	Creates or modifies a class map and enters the Class-map Configuration mode.
<code>no class-map class-map-name</code>	Use the no form of this command to delete a class map.

Table 22-13. Class Mapping CLI Commands (Continued)

CLI Command	Description
match access-group <i>acl-name</i>	Defines the match criteria for classifying traffic.
no match access-group <i>acl-name</i>	Use the no form of this command to delete the match criteria.
show class-map [<i>class-map-name</i>]	Displays information about the class map.

The following is an example of the CLI commands:

```
console(config)# qos advanced
console(config)# class-map class1 match-all
console(config-cmap)# match access-group enterprise
console(config-cmap)# do show class-map class1
Class Map matchAll class1
Match access-group enterprise
```

QoS Policers

This section describes QoS policers.

It contains the following topics:

- QoS Policers Overview
- Aggregate Policers
- Single Policers

QoS Policers Overview

The rate of traffic that matches a pre-defined set of rules can be measured, and limits, such as limiting the rate of file-transfer traffic that is allowed on a port, can be enforced.

This is done by using the ACLs in the class map(s) to match the desired pattern of traffic, and by using a policer to apply QoS on the matching traffic.

A policer is configured with a QoS specification. There are two kinds of policers:

- **Single Policer** — A single policer applies the QoS to a single class map, and to a single flow, based on the policer's QoS specification. When a class map, using a single policer, is bound to multiple ports, each port has its own instance of the single policer; each applying the QoS on the class map (flow) at ports that are otherwise independent of each other. A single policer is created in the **Policy Table** and **Policy Class Maps** pages.
- **Aggregate Policer** — An aggregate policer applies QoS to one or more class maps, and to one or more flows. An aggregation policer can support class maps from various policies. An aggregate policer applies QoS to all its flow(s) in aggregation, regardless of policies and ports. An aggregate policer is created in the **Aggregate Policer** pages.

An aggregate policer is defined if the policer is to be shared with more than one class.

Each policer is defined with its own QoS specification, and is composed of a combination of the following parameters:

- **Committed Information Rate (CIR)** — A maximum allowed rate of traffic, measured in Kbps.
- **Committed Burst Size (CBS)** — An amount of traffic, measured in bytes, which is allowed to pass as a temporary burst, even if it is above the defined maximum rate.
- **Exceed Action** — An action to be applied to frames that are over the limits (called out-of-profile traffic). These frames can be forwarded as is, dropped, or forwarded, after rewriting their DSCP value with a value that marks them as lower-priority frames for all subsequent handling within the device.

A policer is assigned to a class map when a class map is added to a policy.

Aggregate Policers

To define an aggregate policer:

- 1 Click **Quality of Service > QoS Advanced Mode > Aggregate Policers** to display the **Aggregate Policers: Summary** page.

Figure 22-13. Aggregate Policers: Summary

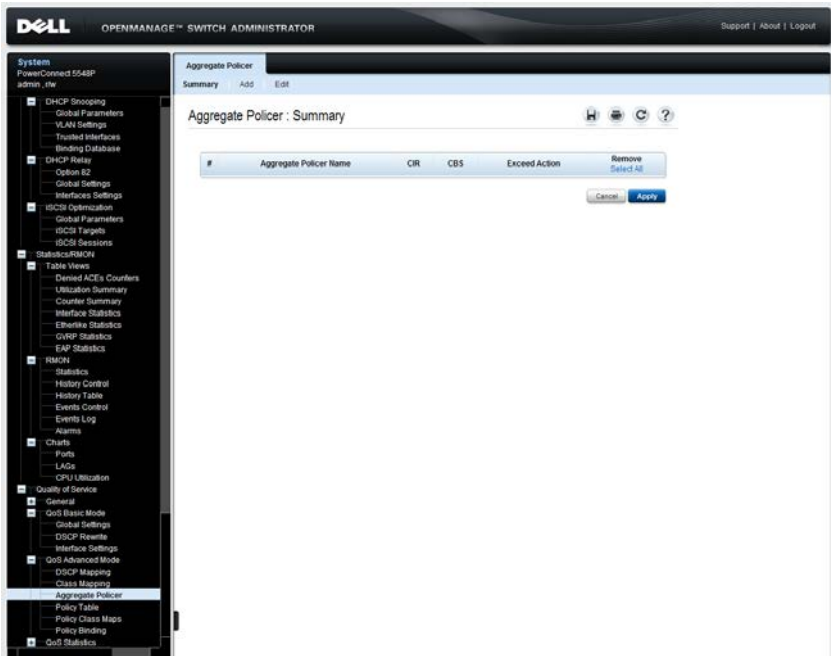

The existing aggregate policers are displayed.

- 2 To add an aggregate policer, click **Add**, and enter the fields.
 - **Aggregate Policers Name** — Enter the name of the Aggregate Policers.
 - **Committed Information Rate (CIR)** — Enter the maximum bandwidth allowed in bits per second. See the description of this field in "Bandwidth" on page 654.
 - **Committed Burst Size (CBS)** — Enter the maximum burst size (even if it goes beyond the CIR) in bytes. See the description of this in the "Bandwidth" on page 654.

- **Exceed Action** — Select the action to be performed on incoming packets that exceed the CIR. The possible options are:
 - **None** — No action is performed on packets exceeding the defined CIR value.
 - **Drop** — Packets exceeding the defined CIR value are dropped.
 - **Remark DSCP** — The DSCP values of packets exceeding the defined CIR value are rewritten to a value entered in the **DSCP Mapping** pages.

Defining Aggregate Policers Using CLI Commands

The following table summarizes the CLI commands for setting the fields in the **Aggregate Policer** pages.

Table 22-14. Aggregate Policer CLI Commands

CLI Command	Description
qos aggregate-policer <i>aggregate-policer-name</i> <i>committed-rate-kbps excess-burst-byte</i> [exceed-action { drop policed-dscp-transmit }]	Defines the policer parameters that can be applied to multiple traffic classes within the same policy map. Use the no form of this command to remove an existing aggregate policer.
no qos aggregate-policer <i>aggregate-policer-name</i>	

The following is an example of the CLI commands:

```
console(config)# qos aggregate-policer policer1 124000
9600 exceed-action drop
```

Single Policers

Defining Aggregate Policers Using CLI Commands

The following table summarizes the CLI commands for setting the fields in the **Aggregate Policer** pages.

Table 22-15. Aggregate Policer CLI Commands

CLI Command	Description
<code>qos aggregate-policer</code> <i>aggregate-policer-name</i> <i>committed-rate-kbps excess-</i> <i>burst-byte</i> [exceed-action { drop policed-dscp-transmit }]	Defines the policer parameters that can be applied to multiple traffic classes within the same policy map. Use the no form of this command to remove an existing aggregate policer.
<code>no qos aggregate-policer</code> <i>aggregate-policer-name</i>	

The following is an example of the CLI commands:

```
console(config)# qos aggregate-policer policer1 124000  
9600 exceed-action drop
```

Single policers are created by:

- 1 Create a policy in the **Police Table** pages
- 2 Configure the policy in the **Policy Class Maps** pages. Here the policy class can be designated as containing a single policer, or it can be designated as containing **Aggregate** policers.

Policy Table

A policy can consist of one of the following:

- One or more class maps of ACLs that define the traffic flows in the policy.
- One or more aggregate policers that apply the QoS to the traffic flows in the policy.

Only those policies that are bound to an interface are active (see the **Policy Binding** pages).

After a policy has been added, class maps can be added in the **Policy Table** pages.

To create a QoS policy:

- 1 Click **Quality of Service > QoS Advanced Mode > Policy Table** to display the **Policy Table: Summary** page.

Figure 22-14. Policy Table: Summary

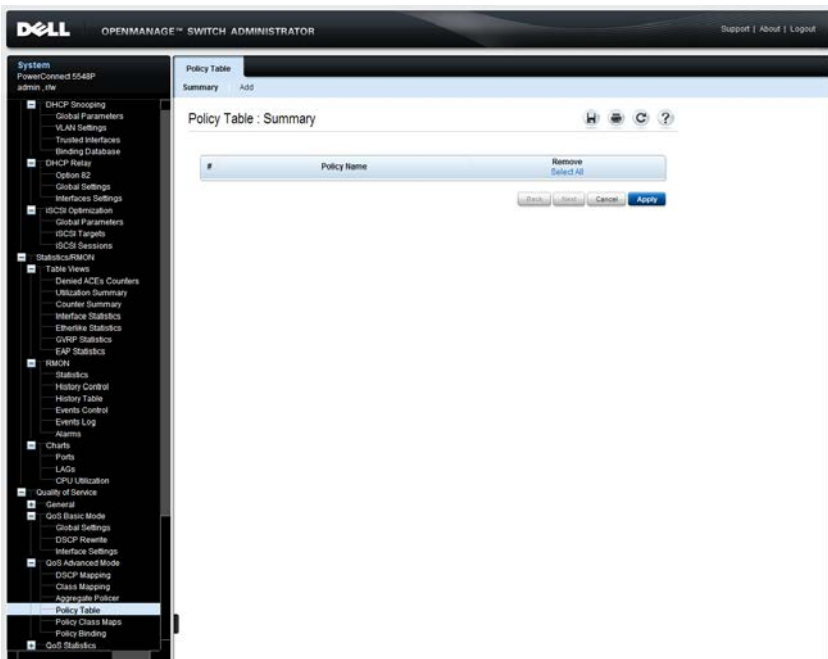

The previously-defined policies are displayed.

- 2 To create a policy, click **Add**.
- 3 Enter the name of the new policy in the **Policy Name** field.
- 4 Add class maps to the new policy in the **Policy Class Maps** page.

Defining Policies Using CLI Commands

The following table summarizes the CLI commands for setting the fields in the **Policy Table** page.

Table 22-16. Policy Table CLI Commands

CLI Command	Description
policy-map <i>policy-map-name</i>	Creates a policy map and enters the Policy-map Configuration mode.
no policy-map <i>policy-map-name</i>	Use the no form of this command to delete a policy map.

The following is an example of the CLI commands:

```
console(config)# policy-map policy1
```

Policy Class Maps

One or more class maps can be added to a policy. A class map defines the type of packets that are considered to belong to the same traffic flow.

To add a class map to a policy:

- 1 Click **Quality of Service > QoS Advanced Mode > Policy Class Maps** to display the **Policy Class Maps: Summary** page.

Figure 22-15. Policy Class Maps: Summary

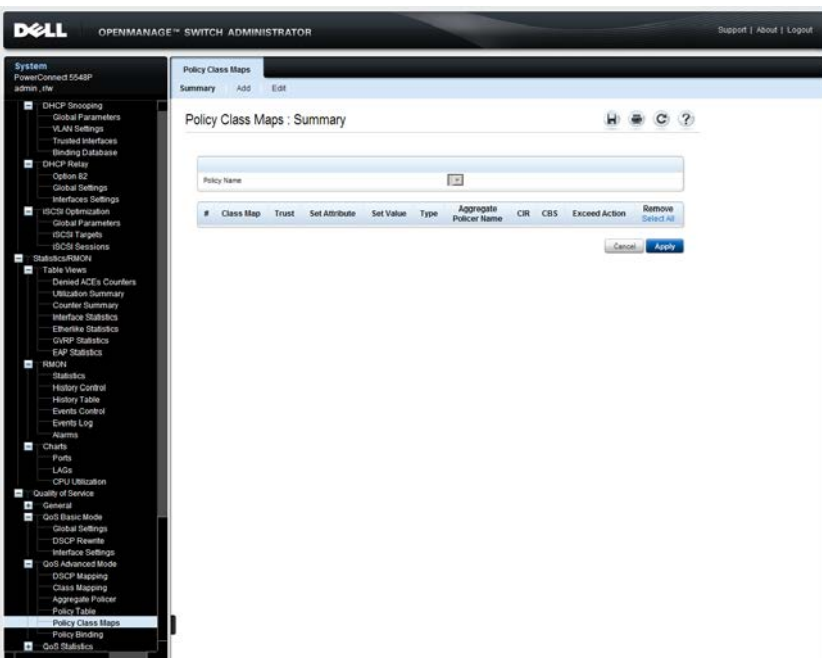

- 2 Select a policy in the **Policy Name** field. The class maps in that policy are displayed.
- 3 To add a class map, click **Add**.
- 4 Enter the parameters.
 - **Policy Name** — Select the policy to which the class map is being added.

- **Class Map Name** — Select an existing class map to be associated with the policy. Class maps are created in the **Class Mapping** pages.
 - **Action Type** — Select the action regarding the ingress CoS and/or DSCP value of all the matching packets.
 - **None** — Ignore the ingress CoS and/or DSCP value. The matching packets are sent as best effort.
 - **Trust CoS, DSCP** — If this option is selected, the switch will trust the CoS or DSCP value of the matching packet. If a packet is an IP packet, the switch will put the packet in the egress queue, based on its DSCP value and the DSCP to Queue mapping. Otherwise, the egress queue of the packet is based on the packet's CoS value and the CoS to Queue mapping.
 - **Set** — See the description of this field below.
 - **Set** — If this option is selected, enter a **New Value**, which determines the egress queue of the matching packets:
 - **DSCP** — If DSCP is selected, the new DSCP value and the DSCP to Queue mapping determines the egress queue of the matching packets.
 - **Queue** — If Queue is selected, the new value is the egress queue number for all matching packets.
 - **CoS** — If CoS is selected, the CoS priority value and the CoS to Queue mapping determines the egress queue of the matching packets.
 - **Police Type** — Available in Layer 2 Mode only. Select the policer type for the policy. The possible options are:
 - **None** — No policy is used.
 - **Single** — The policer for the policy is a single policer.
 - **Aggregate** — The policer for the policy is an aggregate policer.
 - **Aggregate Policer** — Available in Layer 2 Mode only. If Police Type is **Aggregate**, select a previously-defined aggregate policer.
- If **Police Type** is **Single**, enter the following **QoS** parameters:
- **Ingress Committed Information Rate (CIR) (Range: 100 - 1000000)** — Enter the CIR in Kbps. See its description in the **Bandwidth** pages.

- **Ingress Committed Burst Size (CBS)** (Range: 3000 - 16769020) — Enter the CBS in bytes. See its description in the **Bandwidth** pages.
- **Exceed Action** — Select the action assigned to incoming packets exceeding the CIR. The possible options are:
 - **None** — No action.
 - **Drop** — Packets exceeding the defined CIR value are dropped.
 - **Out-of-Profile DSCP** — Packets, exceeding the defined CIR, are forwarded with a new DSCP, derived from the **DSCP Mapping** pages.

Defining Policy Class Maps Using CLI Commands

The following table summarizes the CLI commands for setting the fields in the Policy Class Maps pages.

Table 22-17. Policy Class Maps CLI Commands

CLI Command	Description
class <i>class-map-name</i> [access-group <i>acl-name</i>]	Defines a traffic classification and enters the Policy-map Class Configuration mode.
no class <i>class-map-name</i>	Use the no form of this command to detach a class map from the policy map.
trust [<i>cos-dscp</i>]	Configures the trust state, which selects the value that QoS uses as the source of the internal DSCP value.
no trust	Use the no form of this command to return to the default trust state.
set { dscp <i>new-dscp</i> queue <i>queue-id</i> cos <i>new-cos</i> }	Sets new values in the IP packet.
no set	Use the no form of this command to return to the default values.
police <i>committed-rate-kbps</i> <i>committed-burst-byte</i> [exceed-action { drop policed-dscp-transmit }]	Defines the policer for classified traffic.
no police	Use the no form of this command to remove a policer.

Table 22-17. Policy Class Maps CLI Commands (Continued)

CLI Command	Description
qos aggregate-policer <i>aggregate-policer-name</i> <i>committed-rate-kbps excess-</i> <i>burst-byte</i> [exceed-action { drop policed-dscp-transmit }]	Defines the policer parameters that can be applied to multiple traffic classes. Use the no form of this command to remove an existing aggregate policer.
no qos aggregate-policer <i>aggregate-policer-name</i>	
show policy-map [<i>policy-map-name</i>]	Displays all policy maps or a specific policy map.

The following is an example of the CLI commands:

```
console(config)# policy-map policyl1
console(config-pmap)# class class1 access-group enterprise
console(config-pmap)# trust cos-dscp
console(config-pmap)# set dscp 56
console(config-pmap)# class class1
console(config-pmap-c)# police 124000 9600 exceed-action
drop
console(config)# qos aggregate-policer policer1 124000
9600 exceed-action drop
```

Policy Binding

After policies are created, they must be bound to interfaces (ports or LAGs). When a policy is bound to a specific interface, it becomes active on it (subject to time range restrictions). Only one policy can be active on a single interface, but a single policy can be bound to more than one interface.

When a policy is bound to an interface, it filters and applies QoS to ingress traffic that belongs to the flows defined in the policy. The policy does not apply to traffic egress to the same port.

To edit a policy, it must first be removed (unbound) from all those ports to which it is bound.

To define policy binding:

- 1 Click **Quality of Service > QoS Advanced Mode > Policy Binding** to display the **Policy Binding: Summary** page.

Figure 22-16. Policy Binding: Summary

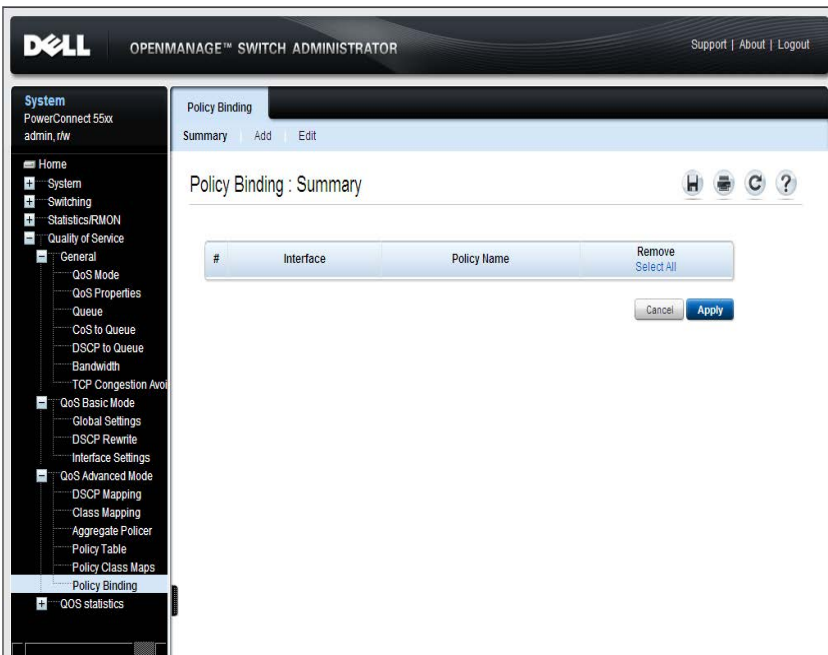

Previously-defined policy bindings are displayed.

- 2 To bind a policy to an interface, click **Add**.
- 3 Select the interface assigned to the policy.
- 4 Select the **Policy Name** to be activated on the interface.

Defining Policy Binding Using CLI Commands

The following table summarizes the CLI commands for setting the fields in the **Policy Binding** pages.

Table 22-18. Policy Binding CLI Commands

CLI Command	Description
service-policy input <i>policy-map-name</i>	Applies a policy map to the input of a particular interface.
no service-policy input	Use the no form of this command to detach a policy map from an interface.

The following is an example of the CLI commands:

```
console(config-if)# service-policy input policy1
```

QoS Statistics

This section describes how to view and manage QoS statistics.

It contains the following topics:

- Policer Statistics
- Aggregated Policer
- Queues Statistics

Policer Statistics

A Single Policer is bound to a class map from a single policy. An Aggregate Policer is bound to one or more class maps from one or more policies.

Use the **Policer Statistics** pages to view the number of in-profile and out-of-profile packets received from an interface that meet the conditions defined in the class map of a policy.

To view policer statistics:

- 1 Click **Quality of Service > QoS Statistics > Policer Statistics** to display the **Policer Statistics: Summary** page.

Figure 22-17. Policer Statistics: Summary

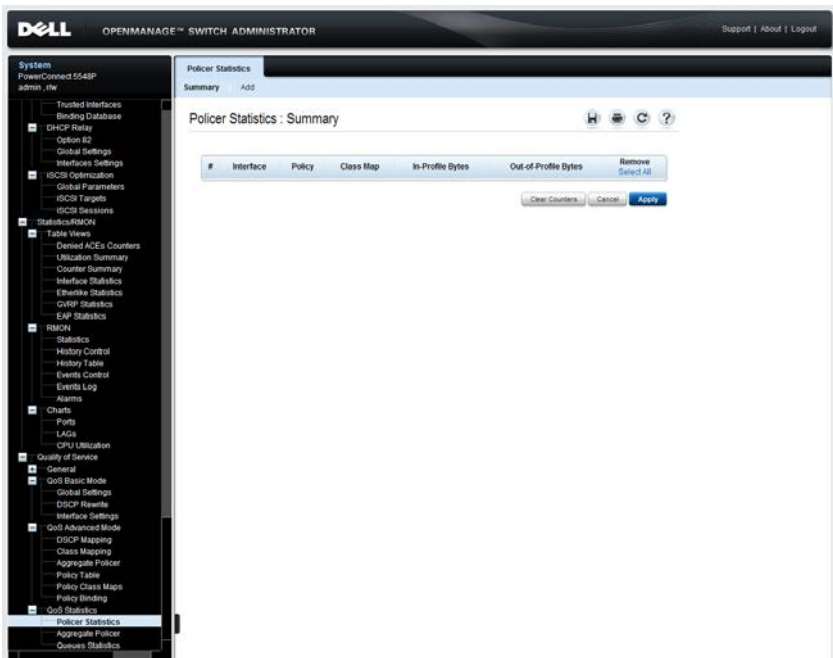

The following statistics for the previously-defined counters are displayed:

- **Interface** — Statistics are displayed for this interface.
- **Policy** — Statistics are displayed for this policy.

- **Class Map** — Statistics are displayed for this class map.
 - **In-Profile Bytes** — Number of in-profile bytes received.
 - **Out-of-Profile Bytes** — Number of out-of-profile bytes received.
- 2** Click **Add** to add a new counter that applies to another policy-class map.
 - 3** Enter the fields:
 - **Interface** — Select the interface for which the counter is defined.
 - **Policy - Class Map Name** — Select a policy class map pair.

Defining Policer Statistics Using CLI Commands

The following table summarizes the CLI commands for setting the fields in the **Policer Statistics** pages.

Table 22-19. Policer Statistics CLI Commands

CLI Command	Description
<code>qos statistics policer policy-map-name class-map-name</code>	Enables counting in-profile and out-of-profile bytes vis-a-vis a policer.
<code>no qos statistics policer policy-map-name class-map-name</code>	Use the no form of this command to disable counting.
<code>clear qos statistics</code>	Clears the statistics
<code>show qos statistics</code>	Displays the statistics

The following is an example of the CLI commands:

```
console(config-if)# qos statistics policer policy1 class1
```

Aggregated Policer

To view aggregated policer statistics:

- 1 Click **Quality of Service > QoS Statistics > Aggregate Policer** to display the **Aggregate Policer: Summary** page.

Figure 22-18. Aggregate Policer: Summary

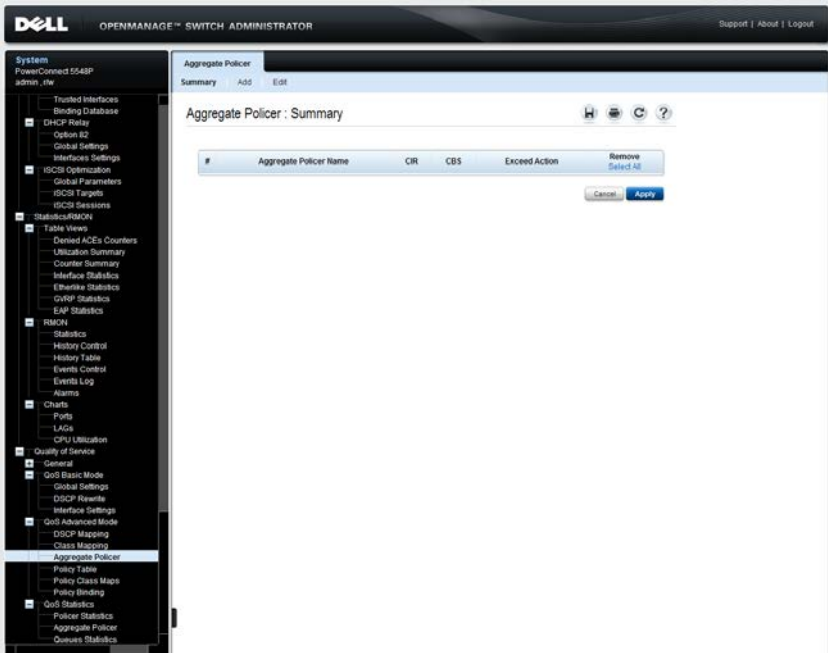

The following statistics for the previously-defined counters are displayed:

- **Aggregate Policer Name** — Policer on which statistics are based.
- **In-Profile Bytes** — Number of in-profile packets that were received.
- **Out-of-Profile Bytes** — Number of out-of-profile packets that were received.

- 2 To add a new counter that applies to another aggregate policer, click **Add**.

- 3 Select an aggregate policer in the **Aggregate Policer Name** field.

Defining Aggregate Policer Statistics Using CLI Commands

The following table summarizes the CLI commands for setting the fields in the **Aggregate Policer Statistics** pages.

Table 22-20. Aggregate Policer Statistics CLI Commands

CLI Command	Description
<code>qos statistics aggregate-policer aggregate-policer-name</code>	Enables counting in-profile and out-of-profile bytes vis-a-vis an aggregate policer.
<code>no qos statistics aggregate-policer aggregate-policer-name</code>	Use the no form of this command to disable counting.
<code>clear qos statistics</code>	Clears the statistics
<code>show qos statistics</code>	Displays the statistics

The following is an example of the CLI commands:

```
console (config)# qos statistics aggregate-policer policer1
```

Queues Statistics

Queue statistics include statistics of forwarded and dropped packets, based on interface, queue, and drop precedence. Lowest drop precedence has the lowest probability of being dropped.

To view Queue Statistics:

- 1 Click Quality of Service > QoS Statistics > Queues Statistics to display the Queues Statistics: Summary.

Figure 22-19. Queues Statistics: Summary

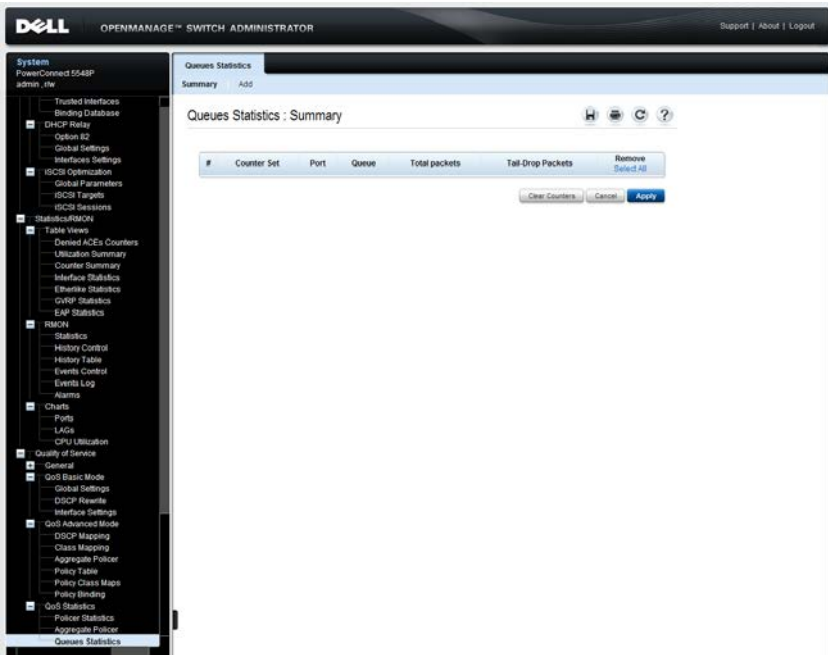

The statistics for previously-defined counters are displayed.

- **Counter Set** —Number of counter.
- **Port** —Number of port.
- **Queue** —Number of queue.
- **Total Packets** —Number of packets forwarded or tail dropped.
- **Tail Drop Packets** —Percentage of packets that were tail dropped.

- 2 To add a new counter, click **Add**, and enter the fields:
 - **Counter Set**—Select the counter set. The possible options are:
 - **Set 1** — Displays the statistics that contains all interfaces and queues with a high DP (Drop Precedence).
 - **Set 2** — Displays the statistics that contains all interfaces and queues with a low DP.
 - **Interface** — Select the unit/interface for which **Queue** statistics are displayed.
 - **Queue** — Select the queue on which packets were forwarded or tail dropped.

Defining QoS Statistics Using CLI Commands

The following table summarizes the CLI commands for setting the fields in the **QoS Statistics** pages.

Table 22-21. QoS Statistics CLI Commands

CLI Command	Description
<code>qos statistics queues set-number {queue/all} {dp/all} {[gigabitethernet tengigabitethernet]port-number/all}</code>	Enables QoS statistics for output queues.
<code>no qos statistics queues set-number</code>	Use the no form of this command to disable QoS statistics for output queues.
<code>clear qos statistics</code>	Clears the statistics
<code>show qos statistics</code>	Displays the statistics

The following is an example of the CLI commands:

```
console(config)# qos statistics queues 1 all all all
```

Glossary

Figure 23-1. This glossary contains key technical words of interest.

A B C D E F G H I L M N O P Q

R S T U V W

A

Access Mode

Specifies the method by which user access is granted to the system.

Access Profiles

Allows network managers to define profiles and rules for accessing the switch module. Access to management functions can be limited to user groups, which are defined by the following criteria:

- Ingress interfaces
- Source IP address or Source IP subnets

ACL

Access Control List. Allow network managers to define classification actions and rules for specific ingress ports.

Aggregated VLAN

Groups several VLANs into a single aggregated VLAN. Aggregating VLANs enables routers to respond to ARP requests for nodes located on different sub-VLANs belonging to the same Super VLAN. Routers respond with their MAC address.

ARP

Address Resolution Protocol. A protocol that converts IP addresses into physical addresses.

ASIC

Application Specific Integrated Circuit. A custom chip designed for a specific application.

Asset Tag

Specifies the user-defined switch module reference.

Authentication Profiles

Sets of rules which that enables login to and authentication of users and applications.

Auto-negotiation

Allows 10/100 Mbps or 10/100/1000 Mbps Ethernet ports to establish for the following features:

- Duplex/Half Duplex mode
- Flow Control
- Speed

B

Back Pressure

A mechanism used with Half Duplex mode that enables a port not to receive a message.

Backplane

The main BUS that carries information in the switch module.

Backup Configuration Files

Contains a backup copy of the switch module configuration. The Backup file changes when the Running Configuration file or the Startup Configuration file is copied to the Backup file.

Bandwidth

Bandwidth specifies the amount of data that can be transmitted in a fixed amount of time. For digital switch modules, bandwidth is defined in Bits per Second (bps) or Bytes per Second.

Bandwidth Assignments

The amount of bandwidth assigned to a specific application, user, or interface.

Baud

The number of signaling elements transmitted each second.

Best Effort

Traffic is assigned to the lowest priority queue, and packet delivery is not guaranteed.

Boot Version

The boot version.

BootP

Bootstrap Protocol. Enables a workstation to discover its IP address, an IP address of a BootP server on a network, or a configuration file loaded into the boot of a switch module.

BPDU

Bridge Protocol Data Unit. Provide bridging information in a message format. BPDUs are sent across switch module information with in Spanning Tree configuration. BPDU packets contain information on ports, addresses, priorities, and forwarding costs.

Bridge

A device that connect two networks. Bridges are hardware specific, however they are protocol independent. Bridges operate at Layer 1 and Layer 2 levels.

Broadcast Domain

device sets that receive Broadcast frames originating from any device within a designated set. Routers bind Broadcast domains, because routers do not forward Broadcast frames.

Broadcasting

A method of transmitting packets to all ports on a network.

Broadcast Storm

An excessive amount of Broadcast messages simultaneously transmitted across a network by a single port. Forwarded message responses are heaped onto the network, overloading network resources or causing the network to time out.

For more information about Broadcast storms, see "LACP Parameters" on page 503.

C**CDB**

Configuration Data Base. A file containing a device's configuration information.

Class of Service

Class of Service (CoS). Class of Service is the 802.1p priority scheme. CoS provides a method for tagging packets with priority information. A CoS value between 0-7 is added to the Layer II header of packets, where zero is the lowest priority and seven is the highest.

A overlapping transmission of two or more packets that collide. The data transmitted cannot be used, and the session is restarted.

CLI

Command Line Interface. A set of line commands used to configure the system. For more information on using the CLI, see **Using the CLI**.

Communities

Specifies a group of users which retains the same system access rights.

CPU

Central Processing Unit. The part of a computer that processes information. CPUs are composed of a control unit and an ALU.

D

DHCP Client

A device using DHCP to obtain configuration parameters, such as a network address.

DHCP Snooping

DHCP Snooping expands network security by providing firewall security between untrusted interfaces and DHCP servers.

DSCP

DiffServe Code Point (DSCP). DSCP provides a method of tagging IP packets with QoS priority information.

Domain

A group of computers and devices on a network that are grouped with common rules and procedures.

Duplex Mode

Permits simultaneous transmissions and reception of data. There are two different types of duplex mode:

- **Full Duplex Mode** — Permits for bisynchronous communication, for example, a telephone. Two parties can transmit information at the same time.
- **Half Duplex Mode** — Permits asynchronous communication, for example, a walkie-talkie. Only one party can transmit information at a time.

Dynamic VLAN Assignment (DVA)

- Allows automatic assignment of users to VLANs during the RADIUS server authentication. When a user is authenticated by the RADIUS server, the user is automatically joined to the VLAN configured on the RADIUS server.

E

Egress Ports

Ports from which network traffic is transmitted.

End System

An end user device on a network.

Ethernet

Ethernet is standardized as per IEEE 802.3. Ethernet is the most common implemented LAN standard. Supports data transfer rates of Mbps, where 10, 100 or 1000 Mbps is supported.

EWS

Embedded Web Server. Provides device management via a standard web browser. Embedded Web Servers are used in addition to or in place of a CLI or NMS.

F

FFT

Fast Forward Table. Provides information about forwarding routes. If a packet arrives to a device with a known route, the packet is forwarded via a route listed in the FFT. If there is not a known route, the CPU forwards the packet and updates the FFT.

FIFO

First In First Out. A queuing process where the first packet in the queue is the first packet out of the packet.

Flapping

Flapping occurs when an interfaces state is constantly changing. For example, an STP port constantly changes from listening to learning to forwarding. This may cause traffic loss.

Flow Control

Enables lower speed devices to communicate with higher speed devices, that is, that the higher speed device refrains from sending packets.

Fragment

Ethernet packets smaller than 576 bits.

Frame

Packets containing the header and trailer information required by the physical medium.

G

GARP

General Attributes Registration Protocol. Registers client stations into a Multicast domain.

Gigabit Ethernet

Gigabit Ethernet transmits at 1000 Mbps, and is compatible with existing 10/100 Mbps Ethernet standards.

GVRP

GARP VLAN Registration Protocol. Registers client stations into a VLANs.

H

HOL

Head of Line. Packets are queued. Packets at the head of the queue are forwarded before packets at the end of the line.

Host

A computer that acts as a source of information or services to other computers.

HTTP

HyperText Transport Protocol. Transmits HTML documents between servers and clients on the internet.

I

IC

Integrated Circuit. Integrated Circuits are small electronic devices composed from semiconductor material.

ICMP

Internet Control Message Protocol. Allows gateway or destination host to communicate with a source host, for example, to report a processing error.

IEEE

Institute of Electrical and Electronics Engineers. An Engineering organization that develops communications and networking standards.

IEEE 802.1d

Used in the Spanning Tree Protocol, IEEE 802.1d supports MAC bridging to avoid network loops.

IEEE 802.1p

Prioritizes network traffic at the data-link/MAC sublayer.

IEEE 802.1Q

Defines the operation of VLAN Bridges that permit the definition, operation, and administration of VLANs within Bridged LAN infrastructures.

IGMP Snooping

IGMP Snooping examines IGMP frame contents, when they are forwarded by the device from work stations to an upstream Multicast router. From the frame, the device identifies work stations configured for Multicast sessions, and which Multicast routers are sending Multicast frames.

Image File

System images are saved in two Flash sectors called images (Image 1 and Image 2). The active image stores the active copy; while the other image stores a second copy.

Ingress Port

Ports on which network traffic is received.

IP

Internet Protocol. Specifies the format of packets and their addressing method. IP addresses packets and forwards the packets to the correct port.

IP Address

Internet Protocol Address. A unique address assigned to a network device with two or more interconnected LANs or WANs.

IP Version 6 (IPv6)

A version of IP addressing with longer addresses than the traditional IPv4. IPv6 addresses are 128 bits long, whereas IPv4 addresses are 32 bits; allowing a much larger address space.

ISATAP

Intra-Site Automatic Tunnel Addressing Protocol.

ISATAP is an automatic overlay tunneling mechanism that uses the underlying IPv4 network as a non-Broadcast/multicast access link layer for IPv6. ISATAP is designed for transporting IPv6 packets within a site where a native IPv6 infrastructure is not yet available.

L

LAG

Link Aggregated Group. Aggregates ports or VLANs into a single virtual port or VLAN.

For more information on LAGs, see **Defining LAG Membership**.

LAN

Local Area Networks. A network contained within a single room, building, campus or other limited geographical area.

Layer 2

Data Link Layer or MAC Layer. Contains the physical address of a client or server station. Layer 2 processing is faster than Layer 3 processing because there is less information to process.

Layer 3

Establishes a connections and ensures that all data arrives to their destination. Packets inspected at the Layer 3 level are analyzed and forwarding decisions, based on their applications.

LLDP-MED

Link Layer Discovery Protocol - Media Endpoint Discovery. LLDP allows network managers to troubleshoot and enhance network management by discovering and maintaining network topologies over multi-vendor environments. MED increases network flexibility by allowing different IP systems to co-exist on a single network LLDP.

Load Balancing

Enables the even distribution of data or processing packets across available network resources. For example, load balancing may distribute the incoming packets evenly to all servers, or redirect the packets to the next available server.

M

MAC Address

Media Access Control Address. The MAC Address is a hardware specific address that identifies each network node.

MAC Address Learning

MAC Address Learning characterizes a learning bridge, in which the packet's source MAC address is recorded. Packets destined for that address are forwarded only to the bridge interface on which that address is located. Packets addressed to unknown addresses are forwarded to every bridge interface. MAC Address Learning minimizes traffic on the attached LANs.

MAC Layer

A sub-layer of the *Data Link Control* (DTL) layer.

Mask

A filter that includes or excludes certain values, for example parts of an IP address.

For example, Unit 2 is inserted in the first minute of a ten-minute cycle, and Unit 1 is inserted in fifth minute of the same cycle, the units are considered the same age.

MD5

Message Digest 5. An algorithm that produces a 128-bit hash. MD5 is a variation of MD4, and increases MD4 security. MD5 verifies the integrity of the communication, authenticates the origin of the communication.

MDI

Media Dependent Interface. A cable used for end stations.

MDIX

Media Dependent Interface with Crossover (MDIX). A cable used for hubs and switches.

MIB

Management Information Base. MIBs contain information describing specific aspects of network components.

Multicast

Transmits copies of a single packet to multiple ports.

N

NA

Neighbor Advertisement.

ND

Neighbor Discovery.

NS

Neighbor Solicitation.

NMS

Network Management System. An interface that provides a method of managing a system.

Node

A network connection endpoint or a common junction for multiple network lines. Nodes include:

- Processors
- Controllers
- Workstations

O

OID

Organizationally Unique Identifiers. Identifiers associated with a Voice VLAN.

OUI

Object Identifier. Used by SNMP to identify managed objects. In the SNMP Manager/Agent network management paradigm, each managed object must have an OID to identify it.

P

Packets

Blocks of information for transmission in packet switched systems.

PDU

Protocol Data Unit. A data unit specified in a layer protocol consisting of protocol control information and layer user data.

PING

Packet Internet Groper. Verifies if a specific IP address is available. A packet is sent to another IP address and waits for a reply.

Port

Physical ports provide connecting components that allow microprocessors to communicate with peripheral equipment.

Port Mirroring

Monitors and mirrors network traffic by forwarding copies of incoming and outgoing packets from one port to a monitoring port.

For more information on port mirroring, see **Defining Port Mirroring Sessions**.

Protocol

A set of rules that governs how devices exchange information across networks.

PVE

Protocol VLAN Edge. A port can be defined as a Private VLAN Edge (PVE) port of an uplink port, so that it will be isolated from other ports within the same VLAN.

Q

QoS

Quality of Service. QoS allows network managers to decide how and what network traffic is forwarded according to priorities, application types, and source and destination addresses.

Query

Extracts information from a database and presents the information for use.

R

RA

RADIUS Advertisement.

RD

RADIUS Discovery.

RS

Router Solicitation.

RADIUS

Remote Authentication Dial-In User Service. A method for authenticating system users, and tracking connection time.

RMON

Remote Monitoring. Provides network information to be collected from a single workstation.

Router

A device that connects to separate networks. Routers forward packets between two or more networks. Routers operate at a Layer 3 level.

RSTP

Rapid Spanning Tree Protocol. Detects and uses network topologies that allow a faster convergence of the spanning tree, without creating forwarding loops.

Running Configuration File

Contains all startup configuration file commands, as well as all commands entered during the current session. After the switch module is powered down or rebooted, all commands stored in the Running Configuration file are lost.

S

Segmentation

Divides LANs into separate LAN segments for bridging. Segmentation eliminates LAN bandwidth limitations.

Server

A central computer that provides services to other computers on a network. Services may include file storage and access to applications.

SNMP

Simple Network Management Protocol. Manages LANs. SNMP based software communicates with network devices with embedded SNMP agents. SNMP agents gather network activity and device status information, and send the information back to a workstation.

SNTP

Simple Network Time Protocol. SNTP assures accurate network switch clock time synchronization up to the millisecond.

SoC

System on a Chip. An ASIC that contains an entire system. For example, a telecom SoC application can contain a microprocessor, digital signal processor, RAM, and ROM.

Spanning Tree Protocol

Prevents loops in network traffic. The Spanning Tree Protocol (STP) provides tree topography for any arrangement of bridges. STP provides one path between end stations on a network, eliminating loops.

SSH

Secure Shell. Permits logging to another computer over a network, execute commands on a remote machine, and move files from one machine to another. Secure Shell provides strong authentication and secure communications methods over insecure channels.

Startup Configuration

Retains the exact switch module configuration when the switch module is powered down or rebooted.

Subnet

Sub-network. Subnets are portions of a network that share a common address component. On TCP/IP networks, devices that share a prefix are part of the same subnet. For example, all devices with a prefix of 157.100.100.100 are part of the same subnet.

Subnet Mask

Used to mask all or part of an IP address used in a subnet address.

Switch

Filters and forwards packets between LAN segments. Switches support any packet protocol type.

T

TCP/IP

Transmissions Control Protocol. Enables two hosts to communicate and exchange data streams. TCP guarantees packet delivery, and guarantees packets are transmitted and received in the order their sent.

Telnet

Terminal Emulation Protocol. Enables system users to log in and use resources on remote networks.

TFTP

Trivial File Transfer Protocol. Uses User Data Protocol (UDP) without security features to transfer files.

Trap

A message sent by the SNMP that indicates that system event has occurred.

Trunking

Link Aggregation. Optimizes port usage by linking a group of ports together to form a single trunk (aggregated groups).

U

UDP

User Data Protocol. Transmits packets but does not guarantee their delivery.

Unicast

A form of routing that transmits one packet to one user.

V

VLAN

Virtual Local Area Networks. Logical subgroups with a Local Area Network (LAN) created via software rather than defining a hardware solution.

VoIP

Voice over IP.

W

WAN

Wide Area Networks. Networks that cover a large geographical area.

Wildcard Mask

Specifies which IP address bits are used, and which bits are ignored. A wild switch module mask of 255.255.255.255 indicates that no bit is important. A wildcard of 0.0.0.0 indicates that all the bits are important.

Index

Numerics

- 24/48 G Ports 35
- 802.1ab (LLDP-MED) 27
- 802.1d 21
- 802.1Q 20, 469, 475

A

- AC unit 42
- Acceptable Frame Type 464
- Access Control Lists 30
- Access mode 322
- Access ports 462
- Access Profile Rules (ACEs) 255
- Access profiles 254, 265
- Accessing the device through the CLI 67
- ACE, IPv4 105
- ACL binding 118
- ACL, IPv4 104
- ACL, IPv6 113
- ACLs 30, 98
- Active users 268
- Address pool 294
- Address Resolution Protocol 242, 695
- Address Tables 416
- Administrator Buttons 87
- Advanced QoS 24
- Advanced Switch Configuration 63
- Aggregate Policer 676, 691
- Aggregated VLAN 695
- Alarms 628
- Anycast 171, 176
- Apply&Save 87
- ARP 242, 244, 695
- ARP inspection 30
- ARP, dynamic inspection 551
- ARP, dynamic inspection list 555
- ARP, dynamic inspection list entries 557
- ARP, global settings 553
- ARP, trusted interfaces 561
- ARP, VLAN settings 559
- Asset 151
- Assignment to hardware queues 641
- Authentication methods 129
- Authentication profiles 262

Auto update, configuration/image file 331
 Automatic aging for MAC addresses 18
 Auto-Negotiation 17

B

Back panel 37, 42
 Back Pressure 16, 380
 Bandwidth 654
 Boot Image Download 81
 Booting the Switch 57
 BootP 23, 697
 BootP and DHCP Clients 23
 BPDU 432, 450, 697
 BPDU Guard 22
 BPDU Handling 432
 Bridge Multicast Forward All 517
 Bridge Multicast Groups 513
 Bridge Protocol Data Unit 697
 Broadcast 172, 176
 Broadcast Storm Control 19
 Buttons 36

C

Cables testing 249
 CBC 308
 Cipher Block-Chaining 308
 Class Mapping 672
 Class of Service 698
 Classic lock 93
 Classic STP 429
 CLI 26, 64, 67, 254
 CLI macro 30
 Clock Source 174
 Command Line Interface 26
 Command Mode Overview 64
 Configuration file 348
 Configuration file download 346
 Configuration using the Setup Wizard 58
 Configuration Work Flow 55
 Configuring Login Banners 74
 Configuring the Stack 58
 Configuring the Switch 54
 Connecting the Switch to the Terminal 56
 Console 262, 265
 Console access 284
 Copying files 355
 CoS 697
 CoS 802.1p support 23
 CoS to Queue 650
 Counter Summary 602
 CPU Utilization 638

D

Daylight Savings Times 163
Default domain names 238
Default Gateway, IPv6 219
Defining device information 151
Denied ACEs Counters 598
Device representation 85
Device structure 34
DHCP 563
DHCP client 23, 290
DHCP limitations 566
DHCP Relay 577
DHCP Relay, global settings 580
DHCP Relay, limitations 578
DHCP Relay, Option 82 Overview 578
DHCP server 31, 290, 292
DHCP server properties 291
DHCP server, retrieving an IP address 68
DHCP Snooping 30, 564
DHCP, global parameters 566
DHCP, trusted interfaces 572
DHCP, VLAN settings 570
DiffServe Code Point 698
DNS 27, 235
Domain 698
Domain Name System 27, 235

Dot1x 28
Dot1x Authentication 127
Download, boot image 81
Download, system image 79
Download, TFTP 347
Download, USB/HTTP 345
Downloading software 76, 330
DSCP 698
DSCP Mapping 670
DSCP Rewrite 661
DST Times 163
Duplex mode 698
DVA 129, 699
Dynamic ACL
 Assignment/Dynamic Policy Assignment (DAACL/DPA) 30
Dynamic Addresses 421
Dynamic addresses 422
Dynamic Policy/ACL Assignment 129
Dynamic VLAN Assignment 136
Dynamic VLAN Assignment (DVA) 129, 699

E

E-911 532
EAP 28, 127
EAP Statistics 612

- Egress ports 699
- Egress Shaping Rates 654
- Emergency Call Service 532
- Enable 275
- Enable passwords 274
- End System 699
- Erase FLASH File 77
- Etherlike Statistics 606
- Ethernet 699
- Events 624
- Events log 627
- EWS 699
- Excluded addresses 299
- Excluding addresses 300
- Extensible Authentication Protocol 28, 127

F

- Fans 155
- Fast Forward Table 699
- Fast link 22, 436, 441
- FFT 699
- FIFO 699
- File information 359
- Filtering 470, 476, 509
- Filtering L2 Multicast Packets 509
- Firmware download 346

- First In First Out 700
- Flapping 700
- Flow Control 380, 700
- Flow Control Support (IEEE 802.3X) 16
- Flow Monitoring (sflow) 25
- Forwarding L2 Multicast Packets 509
- Fragment 700
- Frame 700
- Frame Flow 461
- Front Panel 35
- Full 802.1Q VLAN Tagging Compliance 20

G

- GARP 424, 427, 700
- GARP timers 426
- GARP VLAN Registration Protocol 20, 700
- General Ports 463
- General Switch Information 151
- Generic Attributes Registration Protocol 700
- Giga Port LEDs 40
- Gigabit Ethernet 700
- Global Configuration Mode 65
- Green Ethernet 16

Green Ethernet Configuration 384

ICMP 701

Guest VLAN 21

GVRP 610, 700

GVRP parameters 483

GVRP statistics 609

GVRP Support 20

H

Hardware description 33

Hardware version 364

Hash 174

HDMI port LEDs 41

HDMI ports 35

Head of Line Blocking Prevention 16

Help 87

HMAC-SHA-96 319

HOL 16, 700

Host 700

Host name mapping 240

HTTP 254, 262, 279, 701

HTTP password, configuring 73

HTTPS 254, 257, 262, 279

HyperText Transport Protocol 701

I

IC 701

Icons 87

Identifying a switch via LED 32

IEEE 701

IEEE 802.1d 701

IEEE 802.1p 701

IEEE 802.1Q 20, 701

IEEE 802.1s Multiple Spanning Tree 22

IEEE 802.1w Rapid Spanning Tree 22

IGMP 510

IGMP Snooping 19, 519, 701

Image file 701

Image files, active 354

Information Buttons 87

Ingress port 701

Ingress Rate Limit 654

Interface Configuration Mode 66

Interface Statistics 604

IP 702

IP address from a BOOTP Server 69

IP Addressing 202

IP Version 6 (IPv6) Support 15

IPv4 Interfaces 203

IPv6 Default Gateway 219

IPv6 Interfaces 214

- IPv6 Neighbors 228
- IPv6 Routes Table 232
- IPv6-based ACL 112
- ISATAP 222
- iSCSI 585
- iSCSI Sessions 593, 595
- iSCSI Targets 591
- iSCSI, global parameters 588
- iSCSI, limitations 586
- iSCSI, optimization 31, 584

J

- Jumbo Frames 382

L

- LACP parameters 503
- LAG configuration 403
- LAG membership 506
- LAG statistics 635
- LAGs 23, 500, 517, 702
- LAGs Settings 474
- LAN 702
- Layer 2 702
- Layer 2 Features 19
- Layer 2 Switching 509
- Layer 3 702
- LED Definitions 38
- LEDs 36, 40
- LEDs on Front Panel 36
- Light Emitting Diodes 38
- Limited dynamic lock 93
- Line passwords 272
- Link Aggregated Group 702
- Link aggregation 23, 500, 502
- Link Aggregation and LACP 23
- Link Control Protocol (LCP) packets 393, 445
- Link Layer Discovery Protocol - Media Endpoint Discovery 703
- Link/Duplex/Activity LEDs 40
- LLDP 531
- LLDP MED Port Settings 543
- LLDP Media Endpoint Discovery 532
- LLDP Port Settings 537
- LLDP properties 533
- LLDP-MED 27, 532, 703
- Load Balancing 703
- Loading Software into Stack Members 52
- Local User Database 270
- Location LED 367
- Locked ports 28, 95, 100, 103, 105, 110, 113, 116, 119, 121, 125, 571, 573, 575

Log file in Flash 195
 Logging Global Parameters 189
 Logging Severity Level - Alert 189
 Logging Severity Level - Critical 189
 Logging Severity Level - Debug 189
 Logging Severity Level - Emergency 189
 Logging Severity Level - Error 189
 Logging Severity Level - Informational 189
 Logging Severity Level - Notice 189
 Logging Severity Level - Warning 189
 Login Banners 74
 Login History 196
 Logs 188
 Loops 429

M
 MAC Address Capacity Support 17
 MAC address learning 703
 MAC addresses 93, 703
 MAC addresses, supported features 17
 MAC Layer 703
 MAC Multicast Support 18
 Mac-based ACE 101
 Mac-based ACL 99
 Management Access Lists 255
 Management Access Methods 265
 Management Information Base 307, 704
 Management IP Address Conflict Notification 25
 Management methods 257
 Management security 254
 Managing configuration files on the stack 52
 Manual Time Setting 162
 Mask 703
 MD5 174, 703
 MDI 400, 704
 MDI/MDIX 17, 379
 MDIX 400, 704
 MED Network Policy 540
 Media Endpoint Discovery 540
 Message Digest 5 174, 704
 MIB 307, 704
 Monitoring users 141
 MPS 42
 MST Properties 450
 MSTP 22, 449
 MSTP Instance Settings 454
 MSTP Interface Settings 456

Multicast 508, 517

Multicast TV VLAN 21

Multicast TV VLAN Mapping 529

Multicast TV VLAN Membership
527

Multiple STP (MSTP) 429

N

ND 704

Neighbor Advertisement 704

Neighbor Discovery. 704

Neighbor Solicitation 704

Neighbors 548

Neighbors, IPv6 228

Network Control Protocols 393,
445

Network Management System 704

Network pool 296

NMS 704

NS 704

O

Object ID 308

OID 308

Optical transceiver diagnostics 251

Option 82 578

OUI 497

P

Packets 705

Password configuration 71

Password management 29, 279

Password recovery 78

Passwords 84, 275

Path Cost 432

PDU 705

PING 705

PoE 15, 157

Policer Statistics 689

Policers 675

Policy Binding 686

Policy Table 679

Port 705

Port Configuration 397

Port default settings 380

Port LEDs 38, 40

Port mirroring 19, 411, 705

Port modes 462

Port profile 30

Port representation 85

Port security 93

Port settings 468

Port-based Authentication 127

Port-based Authentication
(Dot1x) 28

Port-based Virtual LANs (VLANs) 20
 Ports 35, 85, 378, 635
 Ports, statistics 633
 Power over Ethernet 15
 Power supplies 42
 Print 87
 Private VLAN 21, 487
 Privileged EXEC Mode 64
 Proprietary Protocol Filtering 31, 120
 Protected Port Configuration 389
 Protected ports 31, 388
 Protected ports, restrictions 388
 Protocol 705
 Protocol Group 477, 478
 Protocol Ports 481
 Protocol VLAN Edge 705
 PVE 705
 PVID 468, 475

Q
 QinQ 462
 QoS 23, 646, 706
 QoS Advanced mode 666
 QoS Basic mode 660
 QoS Modes 643
 QoS Properties 645

QoS, Advanced Mode, Workflow 669
 QoS, Aggregate Policer 676
 QoS, assignment to hardware queues 641
 QoS, Bandwidth 654
 QoS, Basic mode 659
 QoS, Basic Mode, Workflow 659
 QoS, Class Mapping 672
 QoS, DSCP Mapping 670
 QoS, DSCP Rewrite 661
 QoS, DSCP to Queue 652
 QoS, Mapping to Queue 649
 QoS, Policer Statistics 689
 QoS, Policers 674
 QoS, Policy Binding 686
 QoS, Policy Class Maps 682
 QoS, Policy Table 679
 QoS, Queues 646
 QoS, Single Policer 676
 QoS, Statistics 687
 QoS, Traffic Classification 641
 QoS, Trust Mode 664
 Quality of Service 640, 643, 706

R
 RA 706
 RADIUS 264, 284, 706

RADIUS Advertisement 706
 RADIUS client 28
 RADIUS discovery 706
 RADIUS server 284
 RAM Log 193
 Rapid Spanning Tree 444
 Rapid Spanning Tree Protocol 444, 706
 Rapid STP 429, 446, 458
 RD 706
 Rebooting the Stack 52
 Refresh 88
 Registered Multicast Group 509
 Remote Authentication Dial-In User Service 28, 706
 Remote Authorization Dial-In User Service 284
 Remote Log Server 199
 Remote Monitoring 26, 706
 Reset button 36
 Retrieving an IP Address 68
 RMON 615, 618, 619, 706
 RMON Statistics 615, 616
 Router Solicitation 706
 Routes Table, IPv6 232
 RS 706
 RS-232 Console Port 35
 RSTP 22, 444, 706
 Rules 255
 Running Configuration File 330, 706
S
 Secure Shell 284
 Secure Telnet (SSH) 254, 265
 Security Features 28
 Security Management 71
 Segmentation 707
 Selecting the Master and Master Backup Units 49
 Self-Learning MAC Addresses 18
 Server 707
 Set Terminal Baud-Rate 78
 Setup Wizard 58
 sFlow 369
 sFlow interface 374
 sFlow receiver 371
 sFlow statistics 376
 SFP 42
 SFP LEDs 42
 Simple Network Management Protocol 707
 Simple Network Time Protocol 27, 171
 Single Policer 676
 SMMP groups 315

- SNMP 254, 257, 279, 307, 707
- SNMP access rights 308
- SNMP communities 320
- SNMP global parameters 309
- SNMP logs 24
- SNMP Model OIDs 309
- SNMP notification filters 323
- SNMP notification recipients 326
- SNMP users 317
- SNMP Versions 1, 2, and 3 25
- SNMP views 312
- SNTP 27, 171
- SNTP Authentication 177
- SNTP Global Settings 176
- SNTP Servers 180
- Software Download 79
- Software version 364
- Spanning Tree Protocol 21, 429, 707
- SPF LEDs 38, 40
- SSH 29, 257, 262, 279, 707
- SSH password, configuring 73
- SSL 28
- Stack ID LED 42
- Stack management 44, 361
- Stack Menu 78
- Stack Support 15
- Stacking 44
- Stacking failover topology 47
- Stacking, adding a unit to the stack 48
- Stacking, assigning unit IDs 48
- Stacking, automatic assignment of unit IDs 48
- Starting the Application 84
- Startup Configuration 330, 707
- Startup file 330
- Startup Menu 76
- Static addresses 418, 419
- Static hosts 301, 303
- Statistics 596
- Statistics, alarms 628
- Statistics, Counter Summary 602
- Statistics, CPU Utilization 638
- Statistics, Denied ACEs Counters 598
- Statistics, EAP 612
- Statistics, Etherlike 606
- Statistics, events control 624
- Statistics, events log 627
- Statistics, GVRP 609
- Statistics, history control 619
- Statistics, history table 621
- Statistics, Interface Statistics 604
- Statistics, LAGs 635
- Statistics, ports 633

Statistics, QoS 688
 Statistics, Utilization Summary 600
 Storm control 408
 STP 21, 438
 STP BPDU Guard 22
 STP mode 431
 STP port settings 436
 STP, bridge settings 432
 STP, classic 431
 STP, designated roots 433
 STP, LAG settings 441
 Subnet 707
 Subnet Mask 708
 Switch 708
 Switching from the Master to the Backup Master 51
 SYSLOG 188
 System Image Download 79
 System LEDs 38

T

Table Views 597
 TACACS+ 29, 264, 275
 TCP Congestion Avoidance 24, 656
 TCP/IP 708
 TDR technology 249
 Telnet 254, 257, 262, 265, 273, 279, 284, 708
 Telnet Connection 67
 Telnet password, configuring 72
 Terminal Access Controller Access Control System 275
 Terminal Connection 68
 TFTP 26, 708
 Time Domain Reflectometry 249
 Time range 122
 Time range, absolute 123
 Time range, recurring 124
 Time synchronization 162
 Traffic Classification 641
 Traffic limitation methods 646
 Traffic limitation, combination of WRR and Strict Priority 647
 Traffic limitation, Strict Priority 646
 Traffic limitation, Weighted Round Robin (WRR) 646
 Trap 708
 Tree view 84
 Trivial File Transfer Protocol 708
 Trunk Ports 462
 Trunking 708
 Tunnel, ISATAP 222

U

UDP 708
UDP relay 246
Unauthenticated VLAN and Guest VLANs 130
Understanding the interface 84
Unicast 171, 176
Unit ID 361
Unit identification 367
Unregistered Multicast Group 509
Uploading files 349
Uploading files, TFTP 351
Uploading files, USB/HTTP 350
USB File Transfer Protocol 26
USB port 36
User Data Protocol 708
User Security Model 307
Using Dell OpenManage Switch Administrator 83
Using the CLI 64
USM 307
Utilization Summary 600

V

Ventilation System 38
Versions, hardware/software 364

Virtual Local Area Networks 709
VLAN 20, 459, 465, 466, 517, 709
VLAN frame flow 461
VLAN membership 465
VLAN settings, DHCP 570
VLAN Support 20
VLAN to MSTP Instance 452
VLAN, ARP settings 559
VLAN, LAG settings 474
VLAN, port settings 468
VLAN, private 487
VLAN, special cases 461
VLAN, voice 491
VLAN-aware MAC-based Switching 18
Voice VLAN 20, 491
Voice VLAN OUI 497
VoIP 709

W

Warm standby 50
Web access 284
Web management system icons 87
Web-Based Management 25
Weighted Round Robin (WRR) 646

X

XG Ports 35

Revision History

Rev	Date	Description
A5	May 1, 2012	Added "Auto-Update/Configuration Feature" on page 331
A4	April 4, 2012	Made the following corrections: <ul style="list-style-type: none"> • Put a the note (of the recommendation of using HDMI cable version to 1.4 for stacking) more clearly. • Fixed RDP description
A4	April 2, 2012	Following corrections made: <ul style="list-style-type: none"> • Add description regarding the Egress ACL feature • Enter comments regarding the PVLAN feature. • Fixed RDP abbreviation to Reliable Data Protocol in ACL section. • Add the recommendation of using HDMI cable version to 1.4 for stacking
A3	Jan 31, 2012	Corrected command in private VLAN CLI command.
A2	Sept 21, 2011	Entered comment that enabling iSCSI also enables flow control on all interfaces.
A1	Sept 9, 2010	Released to customer

